



2019

Illustrated Price List

Effective March 1, 2019 **CANADA**



PROFILE OF INNOVATION



Dear Tile Professional,

Constant development of innovative solutions for ceramic tile and natural stone installations is the cornerstone of our tradition at Schlüter. The Illustrated Price List, which you hold in your hands, features new and improved products that reflect that tradition.









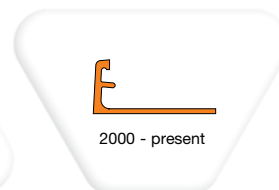
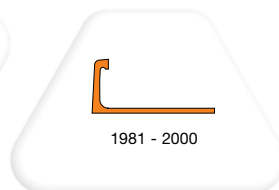
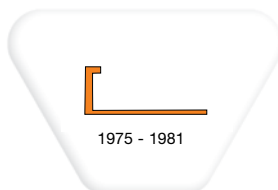



A perfect example is Schlüter®-SCHIENE, which became the foundation of Schlüter's success in 1975. In our tradition of innovation, the simple right-angle profile has since evolved to include an integrated joint spacer. Often, small details result in large advantages for the installer. In this case, the integrated joint spacer makes tile setting easier and cleaner. Gradually, all of our products will be equipped with this feature.

To a large degree, Schlüter®-Systems owes its position as market leader to you, our industry partner. Your input has helped us improve on the function, aesthetic appeal, and safety of our products. Hence, we will keep our ear to the market, so that we may continue to deliver high quality, professional products to specifiers and architects, distributors and dealers, contractors and owners.

Sincerely,

Werner Schlüter



	Product Overview	4 - 10
	Finishing, edge-protection, & transition profiles for floors	11 - 20
	Finishing & edge-protection profiles for walls & countertops	21 - 53
	Stair-nosing profiles	54 - 64
	Movement joint & cove-shaped profiles	65-85
	Profiles for resilient floor & wall coverings	86 - 88
	Schluter®-KERDI-BOARD	89 - 96
	Waterproofing & uncoupling membranes	97 - 102
	Electric floor warming system	103 - 107
	Shower system	108 - 147
	Modular screed system for conventional & radiant-heated screeds	148 - 150
	Setting materials	151 - 153
	Tools	154



A			
Schluter®-ALL-SET	152	Schluter®-DILEX-EKE	74
		Schluter®-DILEX-EKSB	70
		Schluter®-DILEX-EZ 6 + 9	67
B		Schluter®-DILEX-HK	76
Schluter®-BEKOTEC-BRS	150	Schluter®-DILEX-HKS	84
Schluter®-BEKOTEC-BRSK	150	Schluter®-DILEX-HKU	85
Schluter®-BEKOTEC-BRS/KF	150	Schluter®-DILEX-HKW	75
Schluter®-BEKOTEC-BRS/KSF	150	Schluter®-DILEX-KSA	73
Schluter®-BEKOTEC	149	Schluter®-DILEX-KSN	69
Schluter®-BEKOTEC-F	149	Schluter®-DILEX-MOP	66
Schluter®-BEKOTEC-THERM-RH 75	150	Schluter®-DILEX-MP/-MPV	66
		Schluter®-DILEX-PHK	82
D		Schluter®-DITRA	98
Schluter®-DECO	15	Schluter®-DITRA-HEAT	104
Schluter®-DECO-DE	43	Schluter®-DITRA-HEAT-DUO	104
Schluter®-DECO-SG	43 & 147	Schluter®-DITRA-HEAT-E-HK	105
Schluter®-DESIGNBASE-SL	53	Schluter®-DITRA-HEAT-E-KIT	106
Schluter®-DESIGNLINE	42	Schluter®-DITRA-HEAT-E-R	107
Schluter®-DIADEC	39	Schluter®-DITRA-HEAT-E-RR	107
Schluter®-DIADEC-K	39	Schluter®-DITRA-HEAT-E-RT	107
Schluter®-DILEX-AHK	77 - 79	Schluter®-DITRA-HEAT-E-WiFi	107
Schluter®-DILEX-AHKA	80 - 81	Schluter®-DITRA-HEAT/-DITRA-XL-TROWEL	154
Schluter®-DILEX-AKWS	70	Schluter®-DITRA-ROLLER	154
Schluter®-DILEX-AS	72		
Schluter®-DILEX-BT	71		
Schluter®-DILEX-BTO	71		
Schluter®-DILEX-BTS	72		
Schluter®-DILEX-BWA	73		
Schluter®-DILEX-BWB	68		
Schluter®-DILEX-BWS	67		
Schluter®-DILEX-DFP	150		
Schluter®-DILEX-EDP	68		
Schluter®-DILEX-EHK	83		
		Schluter®-DITRA-TROWEL	154
		Schluter®-DITRA-XL	98
		E	
		Schluter®-ECK-E	49
		Schluter®-ECK-K	50
		Schluter®-ECK-KHK	51
		Schluter®-ECK-KI	52
		F	
		Schluter®-FAST-SET	152
		Schluter®-FINEC	40
		I	
		Schluter®-INDEC	41
		J	
		Schluter®-JOLLY	14 & 24 - 26
		K	
		Schluter®-KERDI	99 & 109
		Schluter®-KERDI-BAND	100 & 110
		Schluter®-KERDI-BOARD	90
		Schluter®-KERDI-BOARD-E	91
		Schluter®-KERDI-BOARD-KIT	141
		Schluter®-KERDI-BOARD-SB	92 & 137
		Schluter®-KERDI-BOARD-SC	91 & 136
		Schluter®-KERDI-BOARD-SN	92 & 137
		Schluter®-KERDI-BOARD-U	91
		Schluter®-KERDI-BOARD-V	90
		Schluter®-KERDI-BOARD-ZA	93
		Schluter®-KERDI-BOARD-ZB	94
		Schluter®-KERDI-BOARD-ZC	93
		Schluter®-KERDI-BOARD-ZDK	95



Schluter®-FINEC
(page 40)



Schluter®-KERDI-BOARD-ZFP 96

Schluter®-KERDI-BOARD-ZS 95

Schluter®-KERDI-BOARD-ZSA 96

Schluter®-KERDI-BOARD-ZSD 94

Schluter®-KERDI-BOARD-ZT 95

Schluter®-KERDI-BOARD-ZW 94

Schluter®-KERDI-DRAIN 114 - 125

Schluter®-KERDI-DS 99 & 109

Schluter®-KERDI-FIX 102 & 147

Schluter®-KERDI-FLEX 100

Schluter®-KERDI-KERECK-F 101 & 111

Schluter®-KERDI-KERS 101 & 111

Schluter®-KERDI-KERS-B 101 & 111

Schluter®-KERDI-KM 102 & 112

Schluter®-KERDI-LINE 127 - 132

Schluter®-KERDI-LINE-FC 132

Schluter®-KERDI-SEAL-PS/-MV 102 & 112

Schluter®-KERDI-SHOWER-KIT... 138 - 140

Schluter®-KERDI-SHOWER-LT/-LTS 135

Schluter®-KERDI-SHOWER-SR 136

Schluter®-KERDI-SHOWER-T/-TS/-TT 134

Schluter®-KERDI-TROWEL 154

Schluter®-KERDI-TUBKIT 140

P

Schluter®-PROCUT-TSM 154

Q

Schluter®-QUADEC 34 - 37

Schluter®-QUADEC-FS 38

Schluter®-QUADEC-K 38



R

Schluter®-REMA 52

Schluter®-RENO-RAMP 19

Schluter®-RENO-RAMP-K 19

Schluter®-RENO-T 16

Schluter®-RENO-TK 17

Schluter®-RENO-U 20

Schluter®-RENO-V 18

Schluter®-RONDEC 27 - 33

Schluter®-RONDEC-CT 46 - 47

Schluter®-RONDEC-DB 41

Schluter®-RONDEC-STEP 44 - 46 & 55 - 56

S

Schluter®-SCHIENE 13, 15 & 23

Schluter®-SCHIENE-STEP 48 & 57

Schluter®-SET 152

Schluter®-SHELF 142 - 144

Schluter®-SHOWERPROFILE-R 145

Schluter®-SHOWERPROFILE-S 145

Schluter®-SHOWERPROFILE-WS 146

Schluter®-SHOWERPROFILE-WSK 146

Schluter®-SNIPS 154

T

Schluter®-TREP-E 59

Schluter®-TREP-EFK 63

Schluter®-TREP-EK 63

Schluter®-TREP-FL 58

Schluter®-TREP-G 60

Schluter®-TREP-GK 64

Schluter®-TREP-SE/-S/-B 61

Schluter®-TREP-TAP 62

V

Schluter®-VINPRO-RO 88

Schluter®-VINPRO-S 87

Schluter®-VINPRO-STEP 87

Schluter®-VINPRO-T 87

Schluter®-VINPRO-U 88



Schluter®-SCHIENE /-JOLLY
Page 13 - 15



Schluter®-DECO
Page 15



Schluter®-RENO-T
Page 16



Schluter®-RENO-TK
Page 17



Schluter®-RENO-V
Page 18



Schluter®-RENO-RAMP/-K
Page 19



Schluter®-RENO-U
Page 20



Schluter®-SCHIENE /-JOLLY
Page 23 - 26



Schluter®-RONDEC
Page 27 - 33



Schluter®-QUADEC
Page 34 - 37



Schluter®-QUADEC-K
Page 38



Schluter®-QUADEC-FS
Page 38



Schluter®-DIADEC
Page 39



Schluter®-DIADEC-K
Page 39



 Schluter®-FINEC
Page 40



Schluter®-INDEC
Page 41



Schluter®-RONDEC-DB
Page 41



Schluter®-DESIGNLINE
Page 42



Schluter®-DECO-DE
Page 43



Schluter®-DECO-SG
Page 43



Schluter®-RONDEC-STEP
Page 44 - 46



Schluter®-RONDEC-CT
Page 46 - 47



Schluter®-SCHIENE-STEP
Page 48



Schluter®-ECK-E
Page 49



Schluter®-ECK-K
Page 50



Schluter®-ECK-KHK
Page 51



Schluter®-ECK-KI
Page 52



Schluter®-REMA
Page 52



Schluter®-DESIGNBASE-SL
Page 53

STAIR-NOSING PROFILES



Schluter®-RONDEC-STEP
Page 55 - 56



Schluter®-SCHIENE-STEP
Page 57



Schluter®-TREP-FL
Page 58



Schluter®-TREP-E
Page 59



Schluter®-TREP-G
Page 60



Schluter®-TREP-SE-/S-/B
Page 61

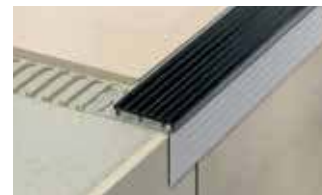

Schluter®-TREP-TAP
Page 62



Schluter®-TREP-EK
Page 63



Schluter®-TREP-EFK
Page 63



Schluter®-TREP-GK
Page 64



Schluter®-DILEX-MOP
Page 66



Schluter®-DILEX-MP/-MPV
Page 66



Schluter®-DILEX-EZ 6 + 9
Page 67



Schluter®-DILEX-BWS
Page 67



Schluter®-DILEX-BWB
Page 68



Schluter®-DILEX-EDP
Page 68



Schluter®-DILEX-KSN
Page 69



Schluter®-DILEX-EKSB
Page 70



Schluter®-DILEX-AKWS
Page 70



Schluter®-DILEX-BT
Page 71



Schluter®-DILEX-BTO
Page 71



Schluter®-DILEX-BTS
Page 72



Schluter®-DILEX-AS
Page 72



Schluter®-DILEX-BWA
Page 73



Schluter®-DILEX-KSA
Page 73



Schluter®-DILEX-EKE
Page 74



Schluter®-DILEX-HKW
Page 75



Schluter®-DILEX-HK
Page 76



Schluter®-DILEX-AHK
Page 77 - 79



Schluter®-DILEX-AHKA
Page 80 - 81



Schluter®-DILEX-PHK
Page 82



Schluter®-DILEX-EHK
Page 83



Schluter®-DILEX-HKS
Page 84



Schluter®-DILEX-HKU
Page 85



Schluter®-VINPRO-S
Page 87



Schluter®-VINPRO-T
Page 87



Schluter®-VINPRO-STEP
Page 87



Schluter®-VINPRO-U
Page 88



Schluter®-VINPRO-RO
Page 88

Schluter®-KERDI-BOARD



Schluter®-KERDI-BOARD
Page 90

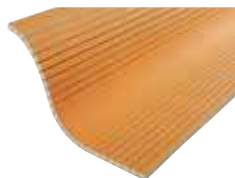

Schluter®-KERDI-BOARD-V
Page 90

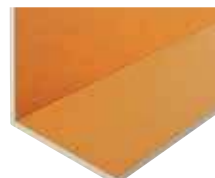

Schluter®-KERDI-BOARD-E
Page 91

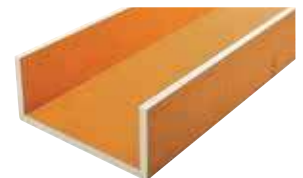

Schluter®-KERDI-BOARD-U
Page 91



Schluter®-KERDI-BOARD-SC
Page 91



Schluter®-KERDI-BOARD-SN
Page 92



Schluter®-KERDI-BOARD-SB
Page 92



Schluter®-KERDI-BOARD-ZC
Page 93



Schluter®-KERDI-BOARD-ZA
Page 93



Schluter®-KERDI-BOARD-ZB
Page 94



Schluter®-KERDI-BOARD-ZW
Page 94



Schluter®-KERDI-BOARD-ZSD
Page 94

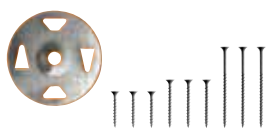

Schluter®-KERDI-BOARD-ZT/-ZS
Page 95



Schluter®-KERDI-BOARD-ZDK
Page 95



Schluter®-KERDI-BOARD-ZSA
Page 96



Schluter®-KERDI-BOARD-ZFP
Page 96



Schluter®-DITRA
Page 98

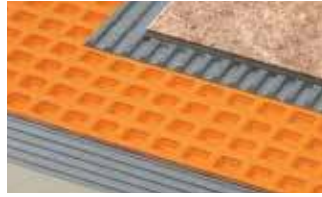

Schluter®-DITRA-XL
Page 98



Schluter®-KERDI-DS
Page 99



Schluter®-KERDI-BAND
Page 100



Schluter®-KERDI-FLEX
Page 100

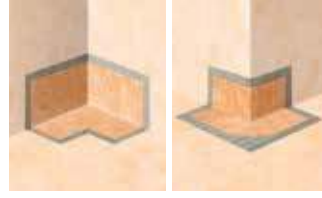

Schluter®-KERDI-KERECK-F
Page 101



Schluter®-KERDI-KERS-B
Page 101

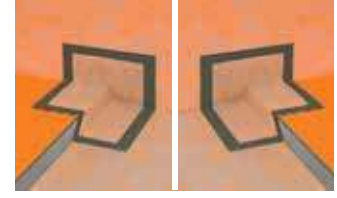

Schluter®-KERDI-KERS
Page 101



Schluter®-KERDI-SEAL-PS/-MV
Page 102



Schluter®-KERDI-KM
Page 102



Schluter®-KERDI-FIX
Page 102



Schluter®-DITRA-HEAT
Page 104



Schluter®-DITRA-HEAT-DUO
Page 104



Schluter®-DITRA-HEAT-E-HK
Page 105

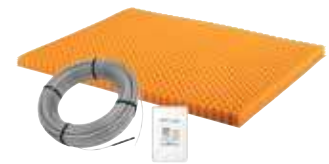

Schluter®-DITRA-HEAT-E-KIT
Page 106



Schluter®-DITRA-HEAT-E-WiFi
Page 107



Schluter®-DITRA-HEAT-E-RT
Page 107



Schluter®-DITRA-HEAT-E-R
Page 107



Schluter®-DITRA-HEAT-E-RR
Page 107



Schluter®-KERDI-DS
Page 109



Schluter®-KERDI-BAND
Page 110

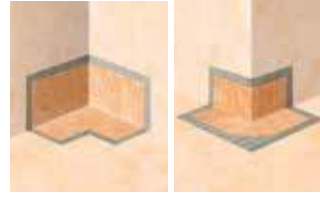

Schluter®-KERDI-KERECK-F
Page 111



Schluter®-KERDI-KERS-B
Page 111

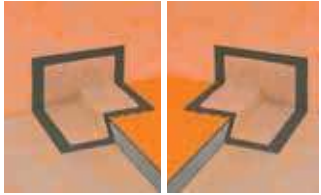

Schluter®-KERDI-KERS
Page 111



Schluter®-KERDI-SEAL-PS/-MV
Page 112



Schluter®-KERDI-KM
Page 112



Schluter®-KERDI-DRAIN
Page 114 - 125



Schluter®-KERDI-LINE
Page 127 - 132



Schluter®-KERDI-LINE-FC
Page 132



▲ Schluter®-KERDI-SHOWER-T/
-TS/-TT
Page 134



▲ Schluter®-KERDI-SHOWER-LT/-LTS
Page 135



Schluter®-KERDI-BOARD-SC
Page 136



Schluter®-KERDI-SHOWER-SR
Page 136



Schluter®-KERDI-BOARD-SB
Page 137



Schluter®-KERDI-BOARD-SN
Page 137



Schluter®-KERDI-SHOWER-KIT
Page 138 - 140



Schluter®-KERDI-TUBKIT
Page 140



▲ Schluter®-KERDI-BOARD-KIT
Page 141



▲ Schluter®-SHELF
Page 142 - 144



Schluter®-SHOWERPROFILE-S
Page 145



Schluter®-SHOWERPROFILE-R
Page 145



Schluter®-SHOWERPROFILE-WS
Page 146



Schluter®-SHOWERPROFILE-WSK
Page 146



Schluter®-DECO-SG
Page 147



Schluter®-KERDI-FIX
Page 147



MODULAR SCREED SYSTEM FOR CONVENTIONAL & RADIANT-HEATED SCREEDS



Schluter®-**BEKOTEC**
Page 149



Schluter®-**BEKOTEC-F**
Page 149



Schluter®-**BEKOTEC-BRS**
Page 150



Schluter®-**BEKOTEC-BRSK**
Page 150

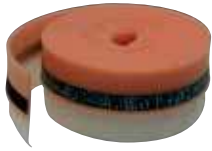

Schluter®-**BEKOTEC-BRS/KF**
Page 150



Schluter®-**BEKOTEC-BRS/KSF**
Page 150



Schluter®-**DILEX-DFP**
Page 150



Schluter®-**BEKOTEC-THERM-RH-75**
Page 150



SETTING MATERIALS



Schluter®-**SET**
Page 152



Schluter®-**ALL-SET**
Page 152



Schluter®-**FAST-SET**
Page 152



TOOLS



Schluter®-**SNIPS**
Page 154



Schluter®-**PROCUT-TSM**
Page 154



Schluter®-**DITRA-TROWEL**
Schluter®-**KERDI-TROWEL**
Schluter®-**DITRA-HEAT/-DITRA-XL-TROWEL**
Page 154



Schluter®-**DITRA Roller**
Page 154



MANUFACTURING

The majority of Schluter® products sold in North America are also produced here. In addition, products produced in North America are shipped overseas for worldwide distribution. International cooperation in product development and support of the local economies are vital elements of our core strategy.



Schluter®-Profiles

FINISHING, EDGE-PROTECTION, & TRANSITION PROFILES FOR FLOORS

Because ceramic and stone tiles are inherently brittle, their exposed edges can chip and crack if left unprotected. Transitions between floor surfaces and at thresholds are particularly vulnerable to damage. Schluter®-Systems offers a variety of profiles to provide edge protection and transitioning at thresholds and between adjacent surfaces, resulting in durable, maintenance-free tiled coverings. Schluter® profiles are available in a variety of shapes, sizes, materials, and finishes.





The following profiles are now available in 10-foot (3.05 m) lengths for floor applications. For available 10-foot profiles for walls, please refer to page 22.

Schluter®-SCHIENE (Page 13)				
▲ Length = 3.05 m - 10'	Stainless steel 304 (1.4301 = V2A) (E)		Satin anodized aluminum (AE)	
H = mm - in.	Item No.	\$ / Length	Item No.	\$ / Length
8 - 5/16	E 80/300	50.70	AE 80/300	14.60
10 - 3/8	E 100/300	53.50	AE 100/300	15.40
12.5 - 1/2	E 125/300	55.30	AE 125/300	15.90

Schluter®-JOLLY (Page 14)						
▲ Length = 3.05 m - 10'	Polished chrome anod. alu. (ACG)		Satin nickel anod. alu. (AT)		Brushed antique bronze anod. alu. (ABGB)	
H = mm - in.	Item No.	\$ / Length	Item No.	\$ / Length	Item No.	\$ / Length
8 - 5/16	A 80 ACG/300	17.40	A 80 AT/300	18.30	A 80 ABGB/300	24.00
10 - 3/8	A 100 ACG/300	17.70	A 100 AT/300	18.90	A 100 ABGB/300	24.30
12.5 - 1/2	A 125 ACG/300	18.30	A 125 AT/300	20.00	A 125 ABGB/300	25.50

Note: Special shipping conditions apply, refer to pages 163-164 for details.

Note: The anchoring leg of **Schluter®-SCHIENE** and **Schluter®-JOLLY** are available with a special radius perforation so that the profile can be used to form curves.

- Price surcharge: \$0.60 per foot
- Available in metal profiles only
- Polished aluminum finishes require a relatively large bending radius
- Item No.: R / Profile No. (e.g., R/E 80/300)
- For delivery time, please call Customer Service





Schluter®-SCHIENE

Schluter®-SCHIENE is designed to provide edging for tile coverings. Typical applications include edge protection where tile is bordered by carpet, at expansion joints, or as a decorative edging for stairs. SCHIENE in aluminum, anodized aluminum, and brass features an integrated joint spacer that establishes a defined joint cavity between the tile and the profile.

Note: Also available in stainless steel 316L (1.4404 = V4A). Contact Customer Service for pricing and availability.

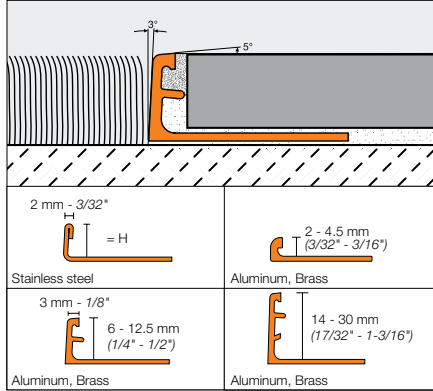

Schluter®-SCHIENE										
Length = 2.5 m - 8' 2-1/2"	Stainless steel 304 (1.4301 = V2A) (E)		Brushed stainless steel 304 (1.4301 = V2A) (EB)		Solid brass (M)		Aluminum (A)		Satin anodized aluminum (AE)	
H = mm - in.	Item No.	\$ / Length	Item No.	\$ / Length	Item No.	\$ / Length	Item No.	\$ / Length	Item No.	\$ / Length
2 - 3/32	E 20	29.51	-	-	-	-	A 20	8.84	AE 20	10.79
3 - 1/8	E 30	32.46	-	-	M 30	31.04	A 30	9.22	AE 30	11.19
4.5 - 3/16	E 45	38.37	-	-	M 45	34.69	A 45	9.33	AE 45	11.37
6 - 1/4	E 60	39.06	E 60 EB	46.87	M 60	36.11	A 60	9.90	AE 60	11.57
7 - 9/32	E 70	39.90	-	-	-	-	A 70	10.08	AE 70	11.64
8 - 5/16	③ E 80	40.59	E 80 EB	48.70	M 80	39.90	A 80	10.37	③ AE 80	11.71
9 - 11/32	E 90	41.80	-	-	M 90	40.29	A 90	10.82	AE 90	12.21
10 - 3/8	③ E 100	42.83	E 100 EB	51.40	M 100	40.70	A 100	11.12	③ AE 100	12.28
11 - 7/16	E 110	43.66	E 110 EB	51.96	M 110	41.71	A 110	11.63	AE 110	12.58
12.5 - 1/2	③ E 125	44.26	E 125 EB	53.11	M 125	42.23	A 125	11.70	③ AE 125	12.75
14 - 17/32	E 140	46.31	-	-	-	-	A 140	12.44	AE 140	13.78
15 - 9/16	E 150	51.68	-	-	M 150	47.30	A 150	12.65	AE 150	14.18
16 - 5/8	E 160	52.45	-	-	M 160	47.62	A 160	12.84	AE 160	14.88
17.5 - 11/16	E 175	53.11	-	-	M 175	48.54	A 175	13.52	AE 175	16.59
20 - 3/4	E 200	55.35	-	-	M 200	49.56	A 200	14.31	AE 200	17.59
21 - 13/16	-	-	-	-	-	-	A 210	14.79	AE 210	18.19
22.5 - 7/8	E 225	57.58	-	-	M 225	60.53	A 225	15.18	AE 225	18.60
25 - 1	E 250	59.72	-	-	M 250	61.66	A 250	15.97	AE 250	19.79
27.5 - 1-1/16	-	-	-	-	-	-	A 275	16.87	AE 275	20.78
30 - 1-3/16	E 300	64.21	-	-	M 300	67.14	A 300	17.56	AE 300	21.89

③ Available in 10' (3.05 m) length. Please refer to page 12.

Note: The anchoring leg of **Schluter®-SCHIENE** is available with a special radius perforation so that the profile can be used to form curves.

- Price surcharge: \$0.60 per foot
- Available in all materials
- Stocked sizes: 6, 8, 10, 11, and 12.5 mm
- Item No.: R / Profile No. (e.g., R/M 80)
- For delivery time on other sizes, please call Customer Service





Schluter®-JOLLY

Schluter®-JOLLY is designed to provide edging for tile coverings and features the same design as Schluter®-SCHIENE. Though JOLLY is typically used in wall applications, the finishes listed in this section can be used in floor applications as well. JOLLY in all finishes features an integrated joint spacer that establishes a defined joint cavity between the tile and the profile.

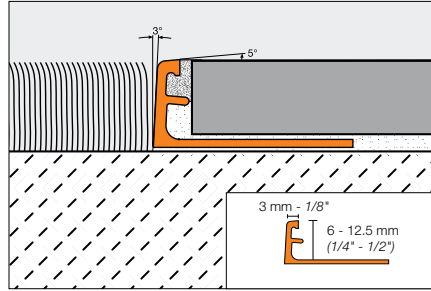

Schluter®-JOLLY

Length = 2.5 m - 8' 2-1/2"	Brushed chrome anod. alu. (ACGB)		Satin nickel anod. alu. (AT)		Brushed nickel anod. alu. (ATGB)		Satin copper anod. alu. (AK)	
H = mm - in.	Item No.	\$ / Length	Item No.	\$ / Length	Item No.	\$ / Length	Item No.	\$ / Length
6 - 1/4	A 60 ACGB	16.17	A 60 AT	13.94	A 60 ATGB	16.66	A 60 AK	14.23
8 - 5/16	A 80 ACGB	17.16	Ⓢ A 80 AT	14.61	A 80 ATGB	17.30	A 80 AK	15.18
10 - 3/8	A 100 ACGB	17.64	Ⓢ A 100 AT	15.09	A 100 ATGB	18.27	A 100 AK	15.69
12.5 - 1/2	A 125 ACGB	18.14	Ⓢ A 125 AT	16.03	A 125 ATGB	19.13	A 125 AK	16.66

Length = 2.5 m - 8' 2-1/2"	Brushed copper anod. alu. (AKGB)		Brushed antique bronze anod. alu. (ABGB)		Satin brass anod. alu. (AM)		Brushed brass anod. alu. (AMGB)	
H = mm - in.	Item No.	\$ / Length	Item No.	\$ / Length	Item No.	\$ / Length	Item No.	\$ / Length
6 - 1/4	A 60 AKGB	16.66	A 60 ABGB	18.26	A 60 AM	13.43	A 60 AMGB	16.17
8 - 5/16	A 80 AKGB	17.64	Ⓢ A 80 ABGB	19.20	A 80 AM	13.92	A 80 AMGB	17.16
10 - 3/8	A 100 AKGB	18.63	Ⓢ A 100 ABGB	19.43	A 100 AM	14.70	A 100 AMGB	17.64
12.5 - 1/2	A 125 AKGB	19.13	Ⓢ A 125 ABGB	20.40	A 125 AM	15.30	A 125 AMGB	18.14

Length = 2.5 m - 8' 2-1/2"	Polished chrome anod. alu. (ACG)		Polished nickel anod. alu. (ATG)		Polished copper anod. alu. (AKG)		Polished brass anod. alu. (AMG)	
H = mm - in.	Item No.	\$ / Length	Item No.	\$ / Length	Item No.	\$ / Length	Item No.	\$ / Length
6 - 1/4	A 60 ACG	13.38	A 60 ATG	16.37	A 60 AKG	16.37	A 60 AMG	15.29
8 - 5/16	Ⓢ A 80 ACG	13.88	A 80 ATG	17.17	A 80 AKG	17.17	A 80 AMG	15.98
10 - 3/8	Ⓢ A 100 ACG	14.17	A 100 ATG	17.65	A 100 AKG	17.65	A 100 AMG	16.58
12.5 - 1/2	Ⓢ A 125 ACG	14.66	A 125 ATG	18.14	A 125 AKG	18.14	A 125 AMG	17.17

Ⓢ Available in 10' (3.05 m) length. Please refer to page 12.

Note: The anchoring leg of **Schluter®-JOLLY** is available with a special radius perforation so that the profile can be used to form curves.

- Price surcharge: \$0.60 per foot
- Available in metal profiles only
- Polished aluminum finishes require a relatively large bending radius
- Stocked sizes: 6, 8, 10, and 12.5 mm
- Item No.: R / Profile No. (e.g., R/A 60 ACGB)
- For delivery time on other sizes, please call Customer Service





Schluter®-SCHIENE-RADIUS

Schluter®-SCHIENE-RADIUS is an extruded profile, with special perforations, for finishing and protecting the edges of curved tile coverings. SCHIENE-RADIUS provides edge protection while enhancing the aesthetic appearance of a curved design, including curved tile-to-tile transitions and curved outside wall corners, as well as curved designs in other surface coverings. Other sizes are available upon request.

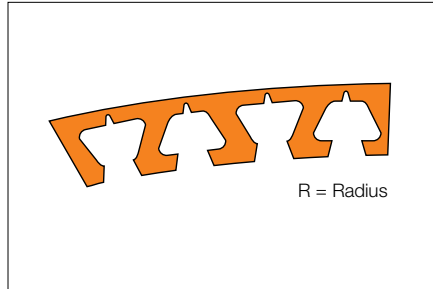

Schluter®-SCHIENE-RADIUS

Length = 2.5 m - 8' 2-1/2"	Stainless steel 304 (1.4301 = V2A) (E)		Solid brass (M)		Aluminum (A)		Satin anodized aluminum (AE)		
	H = mm - in.	Item No.	\$ / Length	Item No.	\$ / Length	Item No.	\$ / Length	Item No.	\$ / Length
	6 - 1/4	R/E 60	43.86	R/M 60	40.91	R/A 60	14.70	R/AE 60	16.37
	8 - 5/16	R/E 80	45.39	R/M 80	44.70	R/A 80	15.17	R/AE 80	16.51
	10 - 3/8	R/E 100	47.63	R/M 100	45.50	R/A 100	15.92	R/AE 100	17.08
	12.5 - 1/2	R/E 125	49.06	R/M 125	47.03	R/A 125	16.50	R/AE 125	17.55

Schluter®-DECO

Schluter®-DECO is designed to provide decorative lines within tile coverings and edge protection at transitions from tile coverings to other same-height surface coverings such as wood or carpet. The profile features a 1/4" (6 mm)-wide visible surface.

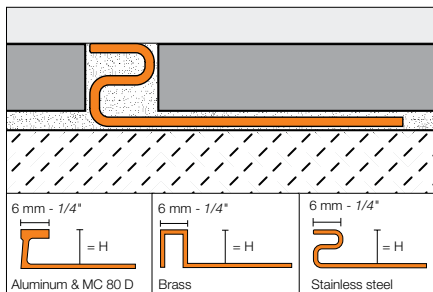

Schluter®-DECO

Length = 2.5 m - 8' 2-1/2"	Stainless steel 304 (1.4301 = V2A) (E)		Solid brass (M)		Chrome-plated solid brass (MC)		Satin anodized aluminum (AE)		
	H = mm - in.	Item No.	\$ / Length	Item No.	\$ / Length	Item No.	\$ / Length	Item No.	\$ / Length
	8 - 5/16	E 80 D	46.79	-	-	MC 80 D	129.17	AE 80 D	19.09
	9 - 11/32	E 90 D	47.30	M 90 D	74.07	MC 90 D	161.47	-	-
	10 - 3/8	E 100 D	48.12	-	-	-	-	AE 100 D	20.74
	11 - 7/16	E 110 D	48.72	M 110 D	79.68	MC 110 D	167.18	-	-
	12.5 - 1/2	E 125 D	49.84	M 125 D	83.66	MC 125 D	172.20	AE 125 D	21.50
	14 - 17/32	E 140 D	50.56	-	-	-	-	-	-
	16 - 5/8	E 160 D	52.17	-	-	-	-	-	-
	18.5 - 23/32	E 185 D	54.02	-	-	-	-	-	-
	21 - 13/16	E 210 D	55.65	-	-	-	-	-	-
	25 - 1	E 250 D	58.71	-	-	-	-	-	-
	30 - 1-3/16	E 300 D	61.96	-	-	-	-	-	-

Note: The anchoring leg of **Schluter®-DECO** is available with a special radius perforation so that the profile can be used to form curves.

- Price surcharge: \$0.60 per foot
- Available in all materials except stainless steel and chrome-plated solid brass
- Item No.: R / Profile No. (e.g., R/M 90 D)
- For delivery time, please call Customer Service





Schluter®-RENO-T

Schluter®-RENO-T is designed to provide transitions between existing, same-height, hard surface floor coverings, primarily in retrofit applications (e.g., ceramic tile or natural stone, parquet flooring, concrete pavers, laminate, etc.). RENO-T, in brass and anodized aluminum size 9/14, is flexible in the lateral direction and can be used in curved applications.

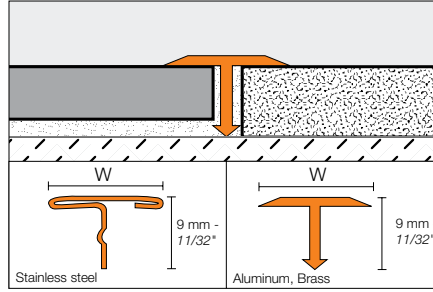

Schluter®-RENO-T

Length = 2.5 m - 8' 2-1/2"	Stainless steel 304 (1.4301 = V2A) (E)		Brushed stainless steel 304 (1.4301 = V2A) (EB)		Solid brass (M)		Satin anodized aluminum (AE)		
	W = mm - in.	Item No.	\$ / Length	Item No.	\$ / Length	Item No.	\$ / Length	Item No.	\$ / Length
	14 - 17/32	T 9/14 E	33.10	T 9/14 EB	31.43	T 9/14 M	23.34	T 9/14 AE	11.45
	25 - 1	T 9/25 E	43.97	T 9/25 EB	43.77	T 9/25 M	39.50	T 9/25 AE	12.96

Length = 2.5 m - 8' 2-1/2"	Satin nickel anod. alu. (AT)		Satin copper anod. alu. (AK)		Satin brass anod. alu. (AM)		
	W = mm - in.	Item No.	\$ / Length	Item No.	\$ / Length	Item No.	\$ / Length
	14 - 17/32	T 9/14 AT	13.71	T 9/14 AK	13.71	T 9/14 AM	12.37
	25 - 1	T 9/25 AT	22.37	T 9/25 AK	22.37	T 9/25 AM	14.03



Schluter®-RENO-TK

Schluter®-RENO-TK is designed to protect tile edges and provide a smooth transition from tile coverings to floor coverings at lower elevations, typically carpet. The 1/4" (6 mm) channel beneath the sloped flange of the profile hides and protects the cut edge of lower adjoining surface coverings. RENO-TK in anodized aluminum sizes 5/16" (8 mm) and larger features an integrated joint spacer that establishes a defined joint cavity between the tile and the profile.

ADA-Compliant

Technical Note: ADA requirements regarding transitions between surfaces of different heights:

- Up to 6 mm (1/4") - no special requirements
- 6 mm (1/4") to 12.5 mm (1/2") - slope ratio, 1:2
- More than 12.5 mm (1/2") - slope ratio, 1:12

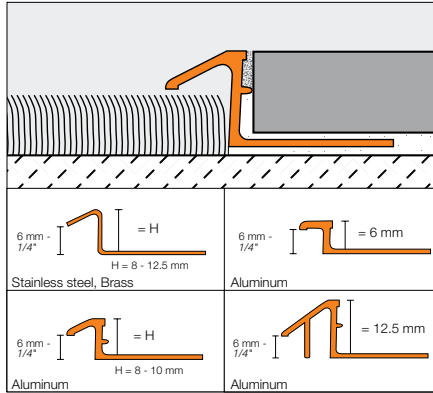
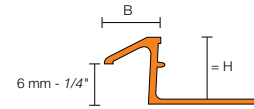

Diagram Values



H = mm - in.	B = mm - in.	
	Aluminum	Stainless steel/Brass
6 - 1/4	7.5 - 19/64	-
8 - 5/16	8.5 - 21/64	7 - 9/32
10 - 3/8	8.5 - 21/64	11 - 7/16
11 - 7/16	-	13.5 - 17/32
12.5 - 1/2	15.5 - 39/64	16.5 - 21/32

Schluter®-RENO-TK						
Length = 2.5 m - 8' 2-1/2"	Stainless steel 304 (1.4301 = V2A) (E)		Brushed stainless steel 304 (1.4301 = V2A) (EB)		Solid brass (M)	
H = mm - in.	Item No.	\$ / Length	Item No.	\$ / Length	Item No.	\$ / Length
8 - 5/16	ETK 80	44.44	EBTK 80	57.76	MTK 80	42.12
10 - 3/8	ETK 100	48.51	EBTK 100	63.06	MTK 100	45.68
11 - 7/16	ETK 110	50.39	EBTK 110	65.05	-	-
12.5 - 1/2	ETK 125	51.68	EBTK 125	67.19	MTK 125	61.96

Length = 2.5 m - 8' 2-1/2"	Satin anodized aluminum (AE)		Bright chrome anod. alu. (ACB)		Satin nickel anod. alu. (AT)		Brushed nickel anod. alu. (ATGB)	
H = mm - in.	Item No.	\$ / Length	Item No.	\$ / Length	Item No.	\$ / Length	Item No.	\$ / Length
6 - 1/4	AETK 60	15.61	ATK 60 ACB	16.88	ATK 60 AT	18.27	-	-
8 - 5/16	AETK 80	16.88	ATK 80 ACB	18.14	ATK 80 AT	19.45	ATK 80 ATGB	21.79
10 - 3/8	AETK 100	18.43	ATK 100 ACB	19.59	ATK 100 AT	23.57	ATK 100 ATGB	23.59
12.5 - 1/2	AETK 125	23.87	ATK 125 ACB	25.02	ATK 125 AT	26.52	ATK 125 ATGB	28.64

Length = 2.5 m - 8' 2-1/2"	Satin copper anod. alu. (AK)		Brushed copper anod. alu. (AKGB)		Brushed antique bronze anod. alu. (ABGB)		Bright brass anod. alu. (AMB)	
H = mm - in.	Item No.	\$ / Length	Item No.	\$ / Length	Item No.	\$ / Length	Item No.	\$ / Length
6 - 1/4	ATK 60 AK	18.27	-	-	-	-	ATK 60 AMB	17.71
8 - 5/16	ATK 80 AK	19.45	ATK 80 AKGB	22.23	ATK 80 ABGB	22.23	ATK 80 AMB	19.39
10 - 3/8	ATK 100 AK	23.57	ATK 100 AKGB	24.07	ATK 100 ABGB	24.07	ATK 100 AMB	20.49
12.5 - 1/2	ATK 125 AK	26.52	ATK 125 AKGB	29.22	ATK 125 ABGB	29.22	ATK 125 AMB	26.03

Note: The anchoring leg of **Schluter®-RENO-TK** is available with a special radius perforation so that the profile can be used to form curves.

- Price surcharge: \$0.60 per foot
- Available in all materials except stainless steel
- Stocked sizes: 6 mm (1/4") - 10 mm (3/8")
- Item No.: R / Profile No. (e.g., R/ATK 100 AMB)
- For delivery time, please call Customer Service





Schluter®-RENO-V

Schluter®-RENO-V is designed to protect tile edges and provide a smooth transition between tile coverings and floor coverings at lower elevations. The profile features a movable transition arm that allows the profile to adjust to the height of the adjacent floor covering via a ball-and-socket joint and eliminates trip hazards. RENO-V features an integrated joint spacer that establishes a defined joint cavity between the tile and the profile.

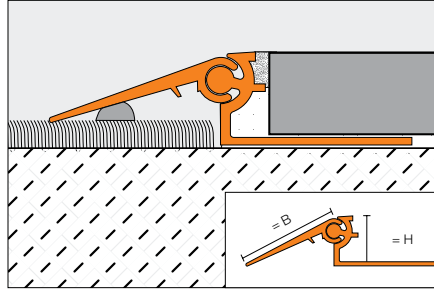

B = 20 mm - 3/4", 30 mm - 1-3/16", 40 mm - 1-9/16"



Schluter®-RENO-V				
Length = 2.5 m - 8' 2-1/2"	Satin anodized aluminum (AE)		Satin brass anodized aluminum (AM)	
	H = mm - in.	Item No.	\$ / Length	Item No.
B = 20 mm - 3/4"				
8 - 5/16	AEVT 80 B20	54.56	AVT 80 B20 AM	55.86
10 - 3/8	AEVT 100 B20	55.86	AVT 100 B20 AM	57.26
12.5 - 1/2	AEVT 125 B20	57.26	AVT 125 B20 AM	58.55
15 - 9/16	AEVT 150 B20	59.24	AVT 150 B20 AM	60.65
17.5 - 11/16	AEVT 175 B20	60.65	AVT 175 B20 AM	61.94
20 - 3/4	AEVT 200 B20	65.33	AVT 200 B20 AM	66.62
B = 30 mm - 1-3/16"				
8 - 5/16	AEVT 80 B30	60.65	AVT 80 B30 AM	60.65
10 - 3/8	AEVT 100 B30	61.94	AVT 100 B30 AM	61.94
12.5 - 1/2	AEVT 125 B30	62.63	AVT 125 B30 AM	63.93
15 - 9/16	AEVT 150 B30	63.93	AVT 150 B30 AM	65.33
17.5 - 11/16	AEVT 175 B30	65.33	AVT 175 B30 AM	66.62
20 - 3/4	AEVT 200 B30	70.01	AVT 200 B30 AM	71.42
B = 40 mm - 1-9/16"				
8 - 5/16	AEVT 80 B40	66.62	AVT 80 B40 AM	68.03
10 - 3/8	AEVT 100 B40	68.03	AVT 100 B40 AM	69.31
12.5 - 1/2	AEVT 125 B40	69.72	AVT 125 B40 AM	70.71
15 - 9/16	AEVT 150 B40	71.42	AVT 150 B40 AM	72.70
17.5 - 11/16	AEVT 175 B40	72.70	AVT 175 B40 AM	74.10
20 - 3/4	AEVT 200 B40	77.41	AVT 200 B40 AM	78.80

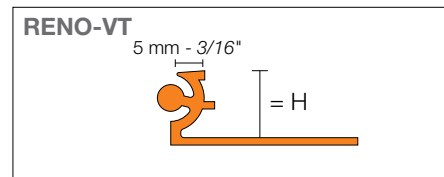
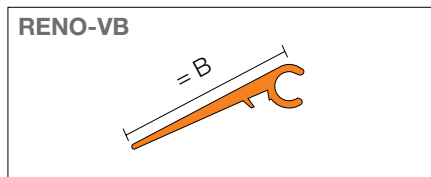

Note: The variable transition arm (VB) and support profile (VT) can be purchased separately. Please contact Customer Service for more information.



Schluter®-RENO-RAMP/-K

Schluter®-RENO-RAMP/-K are designed to protect tile edges and provide a smooth transition between tile coverings and floor coverings at lower elevations or finished concrete. The sloped surface eliminates trip hazards and allows easy access for wheel carts. RENO-RAMP/-K feature an integrated joint spacer that establishes a defined joint cavity between the tile and the profile.

RENO-RAMP has an anchoring leg which is embedded in the tile bond coat.

RENO-RAMP-K is subsequently bonded adjacent to existing floor coverings.

ADA-Compliant

Note: 15 mm (9/16") and 20 mm (3/4") are not ADA-compliant.

Technical Note: ADA requirements regarding transitions between surfaces of different heights:

- Up to 6 mm (1/4") - no special requirements
- 6 mm (1/4") to 12.5 mm (1/2") - slope ratio, 1:2
- More than 12.5 mm (1/2") - slope ratio, 1:12

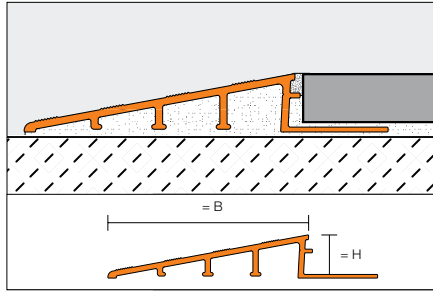

B= 50 mm - 2", 64 mm - 2-1/2", 89 mm - 3-1/2"



Diagram Values	
H = mm - in.	B = mm - in.
6 - 1/4	50 - 2
10 - 3/8	64 - 2-1/2
12.5 - 1/2	64 - 2-1/2
12.5 - 1/2	89 - 3-1/2
15 - 9/16	89 - 3-1/2
20 - 3/4	89 - 3-1/2

Schluter®-RENO-RAMP		
Length = 2.5 m - 8' 2-1/2"	Satin anodized aluminum (AE)	
H = mm - in.	Item No.	\$ / Length
B = 50 mm - 2"		
6 - 1/4	AERP 60 B50	47.23
B = 64 mm - 2-1/2"		
10 - 3/8	AERP 100 B65	47.61
12.5 - 1/2	AERP 125 B65	49.88
B = 89 mm - 3-1/2"		
12.5 - 1/2	AERP 125 B90	63.47
15 - 9/16	AERP 150 B90	65.74
20 - 3/4	AERP 200 B90	69.37

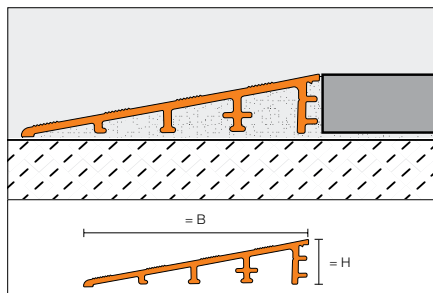

B= 64 mm - 2-1/2"

Schluter®-RENO-RAMP-K		
Length = 2.5 m - 8' 2-1/2"	Satin anodized aluminum (AE)	
H = mm - in.	Item No.	\$ / Length
B = 64 mm - 2-1/2"		
12.5 - 1/2	AERP 125 B65	49.80



Schluter®-RENO-U

Schluter®-RENO-U is designed to protect tile edges and provide a smooth transition between tile coverings and floor coverings at lower elevations or finished concrete. The sloped surface eliminates trip hazards and the leading edge of the profile abuts the lower surface covering. RENO-U in anodized aluminum features an integrated joint spacer that establishes a defined joint cavity between the tile and the profile.

ADA-Compliant

Note: When leading edge abuts lower surface covering, sizes 20 mm (3/4") and 17.5 mm (11/16") are not ADA-compliant. When leading edge rests on top of lower surface covering, sizes 20 mm (3/4"), 15 mm (9/16"), and 17.5 mm (11/16") are not ADA-compliant.

Technical Note: ADA requirements regarding transitions between surfaces of different heights:

- Up to 6 mm (1/4") - no special requirements
- 6 mm (1/4") to 12.5 mm (1/2") - slope ratio, 1:2
- More than 12.5 mm (1/2") - slope ratio, 1:12

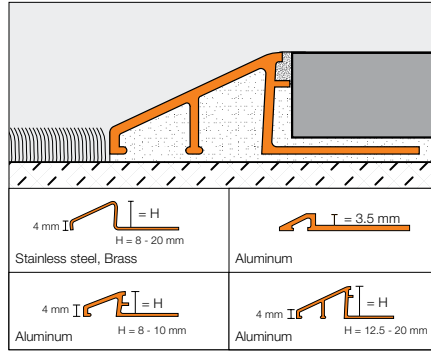
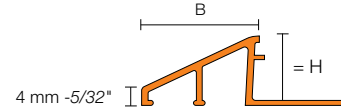

Diagram Values



H = mm - in.	B = mm - in.	
	Aluminum	Stainless steel/Brass
3.5 - 1/8	9 - 23/64	-
8 - 5/16	12.5 - 31/64	13 - 33/64
10 - 3/8	16.5 - 21/32	17.5 - 11/16
11 - 7/16	-	19.5 - 49/64
12.5 - 1/2	22 - 55/64	23 - 29/32
15 - 9/16	27.5 - 1-5/64	28 - 1-7/64
17.5 - 11/16	27 - 1-1/16	33.5 - 1-5/16
20 - 3/4	31.5 - 1-15/64	40 - 1-37/64

Schluter®-RENO-U									
Length = 2.5 m - 8' 2-1/2"	Stainless steel 304 (1.4301 = V2A) (E)		Brushed stainless steel 304 (1.4301 = V2A) (EB)		Solid brass (M)		Satin anodized aluminum (AE)		
	H = mm - in.	Item No.	\$ / Length	Item No.	\$ / Length	Item No.	\$ / Length	Item No.	\$ / Length
	3.5 - 1/8	-	-	-	-	-	-	AEU 35	15.31
	8 - 5/16	EU 80	52.36	EBU 80	80.89	MU 80	55.25	AEU 80	18.34
	10 - 3/8	EU 100	57.26	EBU 100	85.88	MU 100	62.13	AEU 100	19.32
	11 - 7/16	EU 110	58.79	EBU 110	87.66	-	-	-	-
	12.5 - 1/2	EU 125	63.54	EBU 125	92.46	MU 125	77.90	AEU 125	25.52
	15 - 9/16	EU 150	69.11	EBU 150	97.85	MU 150	86.48	AEU 150	32.79
	17.5 - 11/16	EU 175	76.03	EBU 175	104.71	-	-	AEU 175	38.61
	20 - 3/4	EU 200	83.62	EBU 200	112.04	-	-	-	-
Length = 2.5 m - 8' 2-1/2"	Bright chrome anod. alu. (ACB)		Satin nickel anod. alu. (AT)		Brushed nickel anod. alu. (ATGB)		Satin copper anod. alu. (AK)		
	H = mm - in.	Item No.	\$ / Length	Item No.	\$ / Length	Item No.	\$ / Length	Item No.	\$ / Length
	8 - 5/16	AU 80 ACB	21.15	AU 80 AT	18.59	AU 80 ATGB	25.37	AU 80 AK	18.59
	10 - 3/8	AU 100 ACB	24.63	AU 100 AT	20.40	AU 100 ATGB	27.86	AU 100 AK	20.40
	12.5 - 1/2	AU 125 ACB	31.64	AU 125 AT	26.52	AU 125 ATGB	33.63	AU 125 AK	26.52
Length = 2.5 m - 8' 2-1/2"	Brushed copper anod. alu. (AKGB)		Brushed antique bronze anod. alu. (ABGB)		Satin brass anod. alu. (AM)		Bright brass anod. alu. (AMB)		
	H = mm - in.	Item No.	\$ / Length	Item No.	\$ / Length	Item No.	\$ / Length	Item No.	\$ / Length
	8 - 5/16	AU 80 AKGB	25.37	AU 80 ABGB	25.37	AU 80 AM	18.59	AU 80 AMB	21.15
	10 - 3/8	AU 100 AKGB	27.86	AU 100 ABGB	27.86	AU 100 AM	20.40	AU 100 AMB	24.63
	12.5 - 1/2	AU 125 AKGB	33.63	AU 125 ABGB	33.63	AU 125 AM	26.52	AU 125 AMB	31.64



Schluter®-Profiles

FINISHING & EDGE-PROTECTION PROFILES FOR WALLS AND COUNTERTOPS

Ceramic and stone tiles are durable, hygienic, heat resistant, and easy to maintain, representing the ideal surface covering for walls and countertops. However, lack of trim pieces such as bullnose or quarter round in many tile lines can limit designers' options. Schluter®-Systems offers various finishing and edge-protection profiles for walls and countertops that offer increased design flexibility because they can be integrated with any field tile to create a beautiful, durable installation.



Schluter®-FINEC
A tile trim with a minimalist design
Page 40



The following profiles are now available in 10-foot (3.05 m) lengths for wall applications. For available 10-foot profiles for floors, please refer to page 12.

Schluter®-SCHIENE (Page 23)				
▲ Length = 3.05 m - 10'	Stainless steel 304 (1.4301 = V2A) (E)		Satin anodized aluminum (AE)	
H = mm - in.	Item No.	\$ / Length	Item No.	\$ / Length
8 - 5/16	E 80/300	50.70	AE 80/300	14.60
10 - 3/8	E 100/300	53.50	AE 100/300	15.40
12.5 - 1/2	E 125/300	55.30	AE 125/300	15.90

Note: The anchoring leg of **Schluter®-SCHIENE** and **Schluter®-JOLLY** are available with a special radius perforation so that the profile can be used to form curves.

- Price surcharge: \$0.60 per foot
- Available in metal profiles only
- Polished aluminum finishes require a relatively large bending radius R = Radius
- Item No.: R / Profile No. (e.g., R/E 80/300)
- For delivery time, please call Customer Service



Schluter®-JOLLY - Aluminum (Page 24)						
▲ Length = 3.05 m - 10'	Polished chrome anod. alu. (ACG)		Satin nickel anod. alu. (AT)		Brushed antique bronze anod. alu. (ABGB)	
H = mm - in.	Item No.	\$ / Length	Item No.	\$ / Length	Item No.	\$ / Length
8 - 5/16	A 80 ACG/300	17.40	A 80 AT/300	18.30	A 80 ABGB/300	24.00
10 - 3/8	A 100 ACG/300	17.70	A 100 AT/300	18.90	A 100 ABGB/300	24.30
12.5 - 1/2	A 125 ACG/300	18.30	A 125 AT/300	20.00	A 125 ABGB/300	25.50

Schluter®-JOLLY - PVC (Page 26)		
▲ Length = 3.05 m - 10'	Bright White (BW)	
H = mm - in.	Item No.	\$ / Length
8 - 5/16	BW 80/300	5.60
10 - 3/8	BW 100/300	5.90
12.5 - 1/2	BW 125/300	6.10

Schluter®-RONDEC (Page 29)						
▲ Length = 3.05 m - 10'	Satin anodized aluminum (AE)		Polished chrome anod. alu. (ACG)		Satin nickel anod. alu. (AT)	
H = mm - in.	Profile	\$ / Length	Profile	\$ / Length	Profile	\$ / Length
8 - 5/16	RO 80 AE/300	21.50	RO 80 ACG/300	23.60	RO 80 AT/300	23.40
10 - 3/8	RO 100 AE/300	22.40	RO 100 ACG/300	25.00	RO 100 AT/300	24.40
12.5 - 1/2	RO 125 AE/300	26.30	RO 125 ACG/300	29.10	RO 125 AT/300	28.40

Schluter®-QUADEC (Page 35)		
▲ Length = 3.05 m - 10'	Polished chrome anod. alu. (ACG)	
H = mm - in.	Profile	\$ / Length
8 - 5/16	Q 80 ACG/300	26.10
10 - 3/8	Q 100 ACG/300	28.80
12.5 - 1/2	Q 125 ACG/300	33.70

Schluter®-RONDEC-DB (Page 41)		
▲ Length = 3.05 m - 10'	Satin anodized aluminum (AE)	
H = mm - in.	Item No.	\$ / Length
14 - 17/32	DB 14 AE/300	43.90

Note: Special shipping conditions apply, refer to pages 163-164 for details.



Schluter®-SCHIENE

Schluter®-SCHIENE is a finishing and edge-protection profile for the outside corners of tiled surfaces and features the same design as JOLLY. Though SCHIENE is typically used in floor applications, the finishes listed in this section can be used in wall applications as well. SCHIENE in brass and aluminum feature an integrated joint spacer that establishes a defined joint cavity between the tiles and the profile.

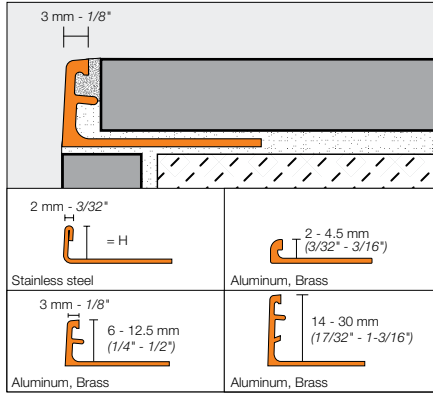

Note: Also available in stainless steel 316L (1.4404 = V4A). Contact Customer Service for pricing and availability.

Schluter®-SCHIENE								
Length = 2.5 m - 8' 2-1/2"	Stainless steel 304 (1.4301 = V2A) (E)		Brushed stainless steel 304 (1.4301 = V2A) (EB)		Solid brass (M)		Satin anodized aluminum (AE)	
H = mm - in.	Item No.	\$/ Length	Item No.	\$/ Length	Item No.	\$/ Length	Item No.	\$/ Length
2 - 3/32	E 20	29.51	-	-	-	-	AE 20	10.79
3 - 1/8	E 30	32.46	-	-	M 30	31.04	AE 30	11.19
4.5 - 3/16	E 45	38.37	-	-	M 45	34.69	AE 45	11.37
6 - 1/4	E 60	39.06	E 60 EB	46.87	M 60	36.11	AE 60	11.57
7 - 9/32	E 70	39.90	-	-	-	-	AE 70	11.64
8 - 5/16	③ E 80	40.59	E 80 EB	48.70	M 80	39.90	③ AE 80	11.71
9 - 11/32	E 90	41.80	-	-	M 90	40.29	AE 90	12.21
10 - 3/8	③ E 100	42.83	E 100 EB	51.40	M 100	40.70	③ AE 100	12.28
11 - 7/16	E 110	43.66	E 110 EB	51.96	M 110	41.71	AE 110	12.58
12.5 - 1/2	③ E 125	44.26	E 125 EB	53.11	M 125	42.23	③ AE 125	12.75
14 - 17/32	E 140	46.31	-	-	-	-	AE 140	13.78
15 - 9/16	E 150	51.68	-	-	M 150	47.30	AE 150	14.18
16 - 5/8	E 160	52.45	-	-	M 160	47.62	AE 160	14.88
17.5 - 11/16	E 175	53.11	-	-	M 175	48.54	AE 175	16.59
20 - 3/4	E 200	55.35	-	-	M 200	49.56	AE 200	17.59
21 - 13/16	-	-	-	-	-	-	AE 210	18.19
22.5 - 7/8	E 225	57.58	-	-	M 225	60.53	AE 225	18.60
25 - 1	E 250	59.72	-	-	M 250	61.66	AE 250	19.79
27.5 - 1-1/16	-	-	-	-	-	-	AE 275	20.78
30 - 1-3/16	E 300	64.21	-	-	M 300	67.14	AE 300	21.89

③ Available in 10' (3.05 m) length. Please refer to page 22.

Note: The anchoring leg of Schluter®-SCHIENE is available with a special radius perforation so that the profile can be used to form curves.

- Price surcharge: \$0.60 per foot
- Available in all materials
- Stocked sizes: 6, 8, 10, 11, and 12.5 mm
- Item No.: R / Profile No. (e.g., R/M 80)
- For delivery time on other sizes, please call Customer Service





Schluter®-JOLLY

Schluter®-JOLLY is a finishing and edge-protection profile for the outside corners of tiled surfaces. The vertical wall section of the profile provides a decorative finish and protects adjacent tiles. Other applications include transitions for dado coverings such as carpet, natural stone, or cold-cured resin coatings. JOLLY in sizes 6 mm (1/4") and higher features an integrated joint spacer that establishes a defined joint cavity between the tile and the profile.

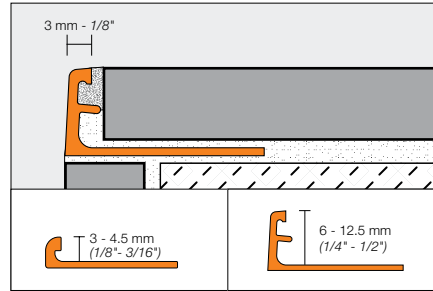

Schluter®-JOLLY								
Length = 2.5 m - 8' 2-1/2"	Chrome-plated solid brass (MC)		Polished chrome anod. alu. (ACG)		Brushed chrome anod. alu. (ACGB)		Satin nickel anod. alu. (AT)	
H = mm - in.	Item No.	\$ / Length	Item No.	\$ / Length	Item No.	\$ / Length	Item No.	\$ / Length
6 - 1/4	MC 60	90.06	A 60 ACG	13.38	A 60 ACGB	16.17	A 60 AT	13.94
8 - 5/16	MC 80	93.26	ⓐ A 80 ACG	13.88	A 80 ACGB	17.16	ⓐ A 80 AT	14.61
10 - 3/8	MC 100	94.46	ⓐ A 100 ACG	14.17	A 100 ACGB	17.64	ⓐ A 100 AT	15.09
12.5 - 1/2	MC 125	96.04	ⓐ A 125 ACG	14.66	A 125 ACGB	18.14	ⓐ A 125 AT	16.03

Length = 2.5 m - 8' 2-1/2"	Polished nickel anod. alu. (ATG)		Brushed nickel anod. alu. (ATGB)		Satin copper anod. alu. (AK)		Polished copper anod. alu. (AKG)	
H = mm - in.	Item No.	\$ / Length	Item No.	\$ / Length	Item No.	\$ / Length	Item No.	\$ / Length
6 - 1/4	A 60 ATG	16.37	A 60 ATGB	16.66	A 60 AK	14.23	A 60 AKG	16.37
8 - 5/16	A 80 ATG	17.17	A 80 ATGB	17.30	A 80 AK	15.18	A 80 AKG	17.17
10 - 3/8	A 100 ATG	17.65	A 100 ATGB	18.27	A 100 AK	15.69	A 100 AKG	17.65
12.5 - 1/2	A 125 ATG	18.14	A 125 ATGB	19.13	A 125 AK	16.66	A 125 AKG	18.14

Length = 2.5 m - 8' 2-1/2"	Brushed copper anod. alu. (AKGB)		Brushed antique bronze anod. alu. (ABGB)		Satin brass anod. alu. (AM)		Polished brass anod. alu. (AMG)	
H = mm - in.	Item No.	\$ / Length	Item No.	\$ / Length	Item No.	\$ / Length	Item No.	\$ / Length
6 - 1/4	A 60 AKGB	16.66	A 60 ABGB	18.26	A 60 AM	13.43	A 60 AMG	15.29
8 - 5/16	A 80 AKGB	17.64	ⓐ A 80 ABGB	19.20	A 80 AM	13.92	A 80 AMG	15.98
10 - 3/8	A 100 AKGB	18.63	ⓐ A 100 ABGB	19.43	A 100 AM	14.70	A 100 AMG	16.58
12.5 - 1/2	A 125 AKGB	19.13	ⓐ A 125 ABGB	20.40	A 125 AM	15.30	A 125 AMG	17.17

Length = 2.5 m - 8' 2-1/2"	Brushed brass anod. alu. (AMGB)		Brushed graphite anod. alu. (AGRB)		Bright black anod. alu. (AGSG)	
H = mm - in.	Item No.	\$ / Length	Item No.	\$ / Length	Item No.	\$ / Length
4.5 - 3/16	-	-	-	-	A 45 AGSG	15.46
6 - 1/4	A 60 AMGB	16.17	A 60 AGRB	18.44	A 60 AGSG	16.21
8 - 5/16	A 80 AMGB	17.16	A 80 AGRB	19.39	A 80 AGSG	17.00
10 - 3/8	A 100 AMGB	17.64	A 100 AGRB	20.00	A 100 AGSG	17.48
12.5 - 1/2	A 125 AMGB	18.14	A 125 AGRB	20.60	A 125 AGSG	17.98

ⓐ Available in 10' (3.05 m) length. Please refer to page 22.

Note: The anchoring leg of **Schluter®-JOLLY** is available with a special radius perforation so that the profile can be used to form curves.

- Price surcharge: \$0.60 per foot
- Available in metal profiles only
- Polished aluminum and chrome-plated brass require a relatively large bending radius
- Stocked sizes: 6, 8, 10, and 12.5 mm
- Item No.: R / Profile No. (e.g., R/A 60 ACGB)
- For delivery time on other sizes, please call Customer Service





Schluter®-TRENDLINE Textured Color-coated Aluminum

Schluter®-JOLLY			
Length = 2.5 m - 8' 2-1/2"		Textured color-coated aluminum (TS)	
H = mm - in.	Profile	\$/ Length	
6 - 1/4	A 60 + color*	31.67	
8 - 5/16	A 80 + color*	32.36	
10 - 3/8	A 100 + color*	33.00	
11 - 7/16	A 110 + color*	33.34	
12.5 - 1/2	A 125 + color*	33.99	

*Color Codes			
TSR Rustic brown	TSDA Dark anthracite	TSLA Light anthracite	TSSG Stone grey
TSC Cream	TSBG Greige	TSI Ivory	TSB Beige
TSOB Bronze	TSG Pewter		

* To complete the item number, add the color code (e.g., A 60 **TSC**).



Matte White and Matte Black

Length = 2.5 m - 8' 2-1/2"		Textured color-coated aluminum	
H = mm - in.	Item No.	\$/ Length	
3 - 1/8	A 30 + color*	24.33	
4.5 - 3/16	A 45 + color*	24.83	
6 - 1/4	A 60 + color*	25.34	
8 - 5/16	A 80 + color*	25.89	
10 - 3/8	A 100 + color*	26.40	
11 - 7/16	A 110 + color*	26.67	
12.5 - 1/2	A 125 + color*	27.20	

*Color Codes	
MGS Matte black	MBW Matte white

* To complete the item number, add the color code (e.g., A 60 **MGS**).



Note: The anchoring leg of **Schluter®-JOLLY** is available with a special radius perforation so that the profile can be used to form curves.

- Price surcharge: \$0.60 per foot
- Available in metal profiles only
- Color-coated profiles require a relatively large bending radius
- Item No.: R / Profile No. (e.g., R/A 80 TSR)
- For delivery time, please call Customer Service





Color-coated Aluminum

Schluter®-JOLLY		
Length = 2.5 m - 8' 2-1/2"	Color-coated aluminum (AC)	
H = mm - in.	Item No.	\$ / Length
3 - 1/8	A 30 + color*	14.74
4.5 - 3/16	A 45 + color*	14.95
6 - 1/4	A 60 + color*	15.50
8 - 5/16	A 80 + color*	16.22
10 - 3/8	A 100 + color*	17.22
11 - 7/16	A 110 + color*	17.77
12.5 - 1/2	A 125 + color*	18.31

*Color Codes			
BW Bright white	W White	SP Sand pebble	BH Bahama
HB Light beige	HG Light grey	PG Classic grey	G Grey
GM Metallic grey	GS Black	RB ¹ Red brown	SB Black brown

* To complete the item number, add the color code (e.g., A 45 G).

¹: RB (Red brown) is only available in sizes 80, 100, and 125.

Note: The anchoring leg of Schluter®-JOLLY is available with a special radius perforation so that the profile can be used to form curves.

- Price surcharge: \$0.60 per foot
- Available in metal profiles only
- Color-coated profiles require a relatively large bending radius
- Item No.: R / Profile No. (e.g., R/A 80 SP)
- For delivery time, please call Customer Service



PVC

Schluter®-JOLLY		
Length = 2.5 m - 8' 2-1/2"	PVC (P)	
H = mm - in.	Item No.	\$ / Length
4.5 - 3/16	color* + 45	4.26
6 - 1/4	color* + 60	4.36
8 - 5/16	³ color* + 80	4.44
10 - 3/8	³ color* + 100	4.71
11 - 7/16	color* + 110	4.81
12.5 - 1/2	³ color* + 125	4.89

*Color Codes			
BW Bright white	W White	SP Sand pebble	BH Bahama
HB Light beige	HG Light grey	PG Classic grey	G Grey
GS Black			

* To complete the item number, add the color code (e.g., G 45).

Schluter®-JOLLY-JUNIOR		
Length = 2.5 m - 8' 2-1/2"	PVC profile without a joint spacer	
H = mm - in.	Item No.	\$ / Length
6 - 1/4	color* + 60 J	3.05
8 - 5/16	color* + 80 J	3.20
11 - 7/16	color* + 110 J	3.52

* To complete the item number, add the color code (e.g., BW 60 J).

Schluter®-JOLLY-JUNIOR is available in:
BW - SP - HB - PG
(Please refer to the color codes table)

³ JOLLY in Bright White (BW) PVC in sizes 80, 100, and 125 is available in 10' (3.05 m) length. Please refer to page 22.

Get perfect cuts!



Schluter®-SNIPS
for PVC profiles. See page 154 for more information.



Schluter®-RONDEC

Schluter®-RONDEC is a finishing and edge-protection profile for tiled edges and outside corners of tiled surfaces. The reveal of the profile forms a symmetrically rounded corner along the surface edge. RONDEC allows for color coordination with tile and grout and the creation of interesting accents in decorative designs. The profile can be combined with the Schluter®-DESIGNLINE border profile for further design options (page 42). RONDEC in aluminum and PVC features an integrated joint spacer that establishes a defined joint cavity between the tile and the profile.

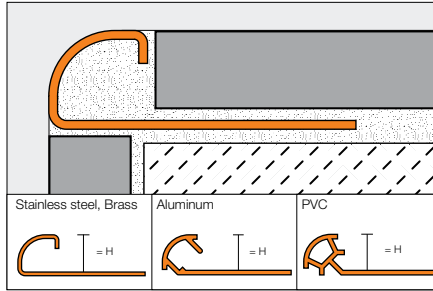

Accessories

All aluminum corners are milled out of solid aluminum, then surface-treated (polished, brushed, etc.) and anodized to ensure durability as well as superior finish and color match.



90° Outside corner (EV)



90° Inside corner (IV)

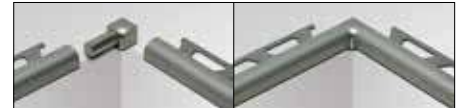

Schluter®-RONDEC prefabricated corners eliminate the need for a mitered edge.

90° Double-leg outside corner (E2L)



90° Double-leg inside corner (I2L)

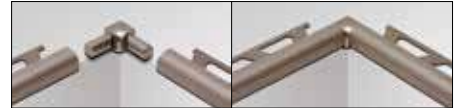

Schluter®-RONDEC double-leg corners simplify the framing of smaller elements with the RONDEC profile, such as niches, windows, etc. The legs are detachable for use in applications where a single-leg corner is needed.



Sink corner with 3/8" (10 mm) radius (I2S/)



Sink corner with 1-1/2" (38 mm) radius (ISK)



Schluter®-RONDEC stainless steel sink corners are used with the RONDEC profile to produce tiled-under sinks. The corners have a large radius (3/8" - 10 mm or 1-1/2" - 38 mm) that allows them to match up to the contour of most standard sinks. The 3/8" corner piece features a double-leg design for ease of installation, while the 1-1/2" corner includes two stainless steel connectors to maintain the alignment of the corner piece and profiles during installation.



Connector Stainless Steel (V)



Connector PVC (V)



Schluter®-RONDEC connectors simplify the alignment of adjacent profile sections. Connectors are made of either PVC for aluminum profiles or stainless steel for stainless steel profiles.



End cap



Schluter®-RONDEC end caps feature a bendable leg that is inserted into the RONDEC profile, and a brushed stainless steel plate that covers the open area of the profile in applications where the end of the profile is to be left exposed. RONDEC end caps can be used with stainless steel and brushed stainless steel RONDEC profiles.



Stainless Steel 304 (1.4301 = V2A)

Note: RONDEC in sizes 60, 80, 100, and 125 is also available in stainless steel 316L (1.4404 = V4A). Contact customer service for price and availability.

Schluter®-RONDEC								
Length = 2.5 m - 8' 2-1/2"								
Stainless steel 304 (1.4301 = V2A) (E)								
H = mm - in.	Profile	\$ / Length	Outside corner, 90°	\$ / Unit	Sink corner 3/8" (10 mm) radius	\$ / Unit	Sink corner 1-1/2" (38 mm) radius	\$ / Unit
4.5 - 3/16	RO 45 E	49.28	EV/RO 45 E	34.39	-	-	-	-
6 - 1/4	RO 60 E	50.26	EV/RO 60 E	35.26	-	-	-	-
7 - 9/32	RO 70 E	52.28	EV/RO 70 E	35.26	-	-	-	-
8 - 5/16	RO 80 E	54.32	EV/RO 80 E	35.26	I2S/RO 80 EV/2A	44.34	ISK/RO 80 E/38	23.09
9 - 11/32	RO 90 E	56.33	EV/RO 90 E	37.98	-	-	-	-
10 - 3/8	RO 100 E	58.34	EV/RO 100 E	40.68	I2S/RO 100 EV/2A	44.34	ISK/RO 100 E/38	23.09
11 - 7/16	RO 110 E	59.24	EV/RO 110 E	40.68	-	-	-	-
12.5 - 1/2	RO 125 E	60.13	EV/RO 125 E	40.68	I2S/RO 125 EV/2A	44.34	ISK/RO 125 E/38	23.09
15 - 9/16	RO 150 E	66.16	EV/RO 150 E	41.97	-	-	-	-

Length = 2.5 m - 8' 2-1/2"					
Brushed stainless steel 304 (1.4301 = V2A) (EB)			Aluminum with stainless steel appearance		
H = mm - in.	End cap	\$ / Unit	Outside corner, 90°	Inside corner, 90°	\$ / Unit
6 - 1/4	-	-	ED/RO 60 E	ID/RO 60 E	7.76
8 - 5/16	EK/RO 80 EB	4.11	ED/RO 80 E	ID/RO 80 E	7.76
10 - 3/8	EK/RO 100 EB	4.11	ED/RO 100 E	ID/RO 100 E	7.76
12.5 - 1/2	EK/RO 125 EB	4.11	ED/RO 125 E	ID/RO 125 E	7.76

Length = 2.5 m - 8' 2-1/2"								
Brushed stainless steel 304 (1.4301 = V2A) (EB)								
H = mm - in.	Profile	\$ / Length	Outside corner, 90°	\$ / Unit	Sink corner 3/8" (10 mm) radius	\$ / Unit	End cap	\$ / Unit
6 - 1/4	RO 60 EB	75.30	EV/RO 60 EB	38.54	-	-	-	-
7 - 9/32	RO 70 EB	76.80	EV/RO 70 EB	38.54	-	-	-	-
8 - 5/16	RO 80 EB	78.69	EV/RO 80 EB	38.54	I2S/RO 80 EB/V2A	44.34	EK/RO 80 EB	4.11
9 - 11/32	RO 90 EB	80.26	EV/RO 90 EB	38.54	-	-	-	-
10 - 3/8	RO 100 EB	82.19	EV/RO 100 EB	41.94	I2S/RO 100 EB/V2A	44.34	EK/RO 100 EB	4.11
11 - 7/16	RO 110 EB	83.84	EV/RO 110 EB	41.94	-	-	-	-
12.5 - 1/2	RO 125 EB	85.77	EV/RO 125 EB	41.94	I2S/RO 125 EB/V2A	44.34	EK/RO 125 EB	4.11
15 - 9/16	RO 150 EB	94.37	EV/RO 150 EB	44.21	-	-	-	-

Stainless steel 304 (1.4301 = V2A) (E)		
H = mm - in.	Connector	\$ / Unit
6 - 1/4	V/RO 60 E	5.07
8 - 5/16	V/RO 80 E	5.07
10 - 3/8	V/RO 100 E	5.07
11 - 7/16	V/RO 110 E	5.07
12.5 - 1/2	V/RO 125 E	5.07

Solid Brass

Schluter®-RONDEC					
Length = 2.5 m - 8' 2-1/2"			Aluminum with polished chrome finish		
Chrome-plated solid brass (MC)					
H = mm - in.	Profile	\$ / Length	Outside corner, 90°	Inside corner, 90°	\$ / Unit
6 - 1/4	RO 60 MC	130.45	EV/RO 60 ACG	IV/RO 60 ACG	9.12
8 - 5/16	RO 80 MC	137.94	EV/RO 80 ACG	IV/RO 80 ACG	9.12
10 - 3/8	RO 100 MC	143.92	EV/RO 100 ACG	IV/RO 100 ACG	9.12
12.5 - 1/2	RO 125 MC	151.60	EV/RO 125 ACG	IV/RO 125 ACG	9.12



Anodized Aluminum

Schluter®-RONDEC							
Length = 2.5 m - 8' 2-1/2"		Satin anodized aluminum (AE)					
H = mm - in.	Profile	\$/ Length	Outside corner, 90°	Inside corner, 90°	\$/ Unit	Connector	\$/ Unit
6 - 1/4	RO 60 AE	15.53	EV/RO 60 AE	IV/RO 60 AE	7.82	V/RO 60	2.14
8 - 5/16	3 RO 80 AE	17.17	EV/RO 80 AE	IV/RO 80 AE	7.82	V/RO 80	2.14
10 - 3/8	3 RO 100 AE	17.89	EV/RO 100 AE	IV/RO 100 AE	7.82	V/RO 100	2.14
12.5 - 1/2	3 RO 125 AE	21.06	EV/RO 125 AE	IV/RO 125 AE	7.82	V/RO 125	2.14

H = mm - in.	Double-leg outside corner, 90°	Double-leg inside corner, 90°	\$/ Unit
8 - 5/16	E2L/RO 80 AE	I2L/RO 80 AE	13.55
10 - 3/8	E2L/RO 100 AE	I2L/RO 100 AE	13.55
12.5 - 1/2	E2L/RO 125 AE	I2L/RO 125 AE	13.55

Length = 2.5 m - 8' 2-1/2"		Polished chrome anod. alu. (ACG)					
H = mm - in.	Profile	\$/ Length	Outside corner, 90°	Inside corner, 90°	\$/ Unit	Connector	\$/ Unit
6 - 1/4	RO 60 ACG	17.77	EV/RO 60 ACG	IV/RO 60 ACG	9.12	V/RO 60	2.14
8 - 5/16	3 RO 80 ACG	18.85	EV/RO 80 ACG	IV/RO 80 ACG	9.12	V/RO 80	2.14
10 - 3/8	3 RO 100 ACG	20.00	EV/RO 100 ACG	IV/RO 100 ACG	9.12	V/RO 100	2.14
12.5 - 1/2	3 RO 125 ACG	23.31	EV/RO 125 ACG	IV/RO 125 ACG	9.12	V/RO 125	2.14

H = mm - in.	Double-leg outside corner, 90°	Double-leg inside corner, 90°	\$/ Unit
8 - 5/16	E2L/RO 80 ACG	I2L/RO 80 ACG	13.82
10 - 3/8	E2L/RO 100 ACG	I2L/RO 100 ACG	13.82
12.5 - 1/2	E2L/RO 125 ACG	I2L/RO 125 ACG	13.82

Length = 2.5 m - 8' 2-1/2"		Brushed chrome anod. alu. (ACGB)					
H = mm - in.	Profile	\$/ Length	Outside corner, 90°	Inside corner, 90°	\$/ Unit	Connector	\$/ Unit
6 - 1/4	RO 60 ACGB	19.39	EV/RO 60 ACGB	IV/RO 60 ACGB	15.58	V/RO 60	2.14
8 - 5/16	RO 80 ACGB	20.57	EV/RO 80 ACGB	IV/RO 80 ACGB	15.58	V/RO 80	2.14
10 - 3/8	RO 100 ACGB	21.88	EV/RO 100 ACGB	IV/RO 100 ACGB	15.58	V/RO 100	2.14
12.5 - 1/2	RO 125 ACGB	25.44	EV/RO 125 ACGB	IV/RO 125 ACGB	15.58	V/RO 125	2.14

H = mm - in.	Double-leg outside corner, 90°	Double-leg inside corner, 90°	\$/ Unit
8 - 5/16	E2L/RO 80 ACGB	I2L/RO 80 ACGB	17.04
10 - 3/8	E2L/RO 100 ACGB	I2L/RO 100 ACGB	17.04
12.5 - 1/2	E2L/RO 125 ACGB	I2L/RO 125 ACGB	17.04

Length = 2.5 m - 8' 2-1/2"		Satin nickel anod. alu. (AT)					
H = mm - in.	Profile	\$/ Length	Outside corner, 90°	Inside corner, 90°	\$/ Unit	Connector	\$/ Unit
6 - 1/4	RO 60 AT	17.01	EV/RO 60 AT	IV/RO 60 AT	7.83	V/RO 60	2.14
8 - 5/16	3 RO 80 AT	18.75	EV/RO 80 AT	IV/RO 80 AT	7.83	V/RO 80	2.14
10 - 3/8	3 RO 100 AT	19.52	EV/RO 100 AT	IV/RO 100 AT	7.83	V/RO 100	2.14
12.5 - 1/2	3 RO 125 AT	22.68	EV/RO 125 AT	IV/RO 125 AT	7.83	V/RO 125	2.14

H = mm - in.	Double-leg outside corner, 90°	Double-leg inside corner, 90°	\$/ Unit
8 - 5/16	E2L/RO 80 AT	I2L/RO 80 AT	13.68
10 - 3/8	E2L/RO 100 AT	I2L/RO 100 AT	13.68
12.5 - 1/2	E2L/RO 125 AT	I2L/RO 125 AT	13.68

3 Available in 10' (3.05 m) length. Please refer to page 22.



Schluter®-RONDEC							
Length = 2.5 m - 8' 2-1/2"	Polished nickel anod. alu. (ATG)						
H = mm - in.	Profile	\$ / Length	Outside corner, 90°	Inside corner, 90°	\$ / Unit	Connector	\$ / Unit
6 - 1/4	RO 60 ATG	18.65	EV/RO 60 ATG	IV/RO 60 ATG	9.12	V/RO 60	2.14
8 - 5/16	RO 80 ATG	19.81	EV/RO 80 ATG	IV/RO 80 ATG	9.12	V/RO 80	2.14
10 - 3/8	RO 100 ATG	21.07	EV/RO 100 ATG	IV/RO 100 ATG	9.12	V/RO 100	2.14
12.5 - 1/2	RO 125 ATG	24.57	EV/RO 125 ATG	IV/RO 125 ATG	9.12	V/RO 125	2.14

H = mm - in.	Double-leg outside corner, 90°	Double-leg inside corner, 90°	\$ / Unit
8 - 5/16	E2L/RO 80 ATG	I2L/RO 80 ATG	13.82
10 - 3/8	E2L/RO 100 ATG	I2L/RO 100 ATG	13.82
12.5 - 1/2	E2L/RO 125 ATG	I2L/RO 125 ATG	13.82

Length = 2.5 m - 8' 2-1/2"	Brushed nickel anod. alu. (ATGB)						
H = mm - in.	Profile	\$ / Length	Outside corner, 90°	Inside corner, 90°	\$ / Unit	Connector	\$ / Unit
6 - 1/4	RO 60 ATGB	19.78	EV/RO 60 ATGB	IV/RO 60 ATGB	15.58	V/RO 60	2.14
8 - 5/16	RO 80 ATGB	20.95	EV/RO 80 ATGB	IV/RO 80 ATGB	15.58	V/RO 80	2.14
10 - 3/8	RO 100 ATGB	21.89	EV/RO 100 ATGB	IV/RO 100 ATGB	15.58	V/RO 100	2.14
12.5 - 1/2	RO 125 ATGB	26.00	EV/RO 125 ATGB	IV/RO 125 ATGB	15.58	V/RO 125	2.14

H = mm - in.	Double-leg outside corner, 90°	Double-leg inside corner, 90°	\$ / Unit
8 - 5/16	E2L/RO 80 ATGB	I2L/RO 80 ATGB	17.04
10 - 3/8	E2L/RO 100 ATGB	I2L/RO 100 ATGB	17.04
12.5 - 1/2	E2L/RO 125 ATGB	I2L/RO 125 ATGB	17.04

Length = 2.5 m - 8' 2-1/2"	Satin copper anod. alu. (AK)						
H = mm - in.	Profile	\$ / Length	Outside corner, 90°	Inside corner, 90°	\$ / Unit	Connector	\$ / Unit
6 - 1/4	RO 60 AK	17.01	EV/RO 60 AK	IV/RO 60 AK	7.76	V/RO 60	2.14
8 - 5/16	RO 80 AK	18.75	EV/RO 80 AK	IV/RO 80 AK	7.76	V/RO 80	2.14
10 - 3/8	RO 100 AK	19.90	EV/RO 100 AK	IV/RO 100 AK	7.76	V/RO 100	2.14
12.5 - 1/2	RO 125 AK	22.68	EV/RO 125 AK	IV/RO 125 AK	7.76	V/RO 125	2.14

H = mm - in.	Double-leg outside corner, 90°	Double-leg inside corner, 90°	\$ / Unit
8 - 5/16	E2L/RO 80 AK	I2L/RO 80 AK	13.55
10 - 3/8	E2L/RO 100 AK	I2L/RO 100 AK	13.55
12.5 - 1/2	E2L/RO 125 AK	I2L/RO 125 AK	13.55

Length = 2.5 m - 8' 2-1/2"	Polished copper anod. alu. (AKG)						
H = mm - in.	Profile	\$ / Length	Outside corner, 90°	Inside corner, 90°	\$ / Unit	Connector	\$ / Unit
6 - 1/4	RO 60 AKG	18.65	EV/RO 60 AKG	IV/RO 60 AKG	9.04	V/RO 60	2.14
8 - 5/16	RO 80 AKG	19.81	EV/RO 80 AKG	IV/RO 80 AKG	9.04	V/RO 80	2.14
10 - 3/8	RO 100 AKG	21.07	EV/RO 100 AKG	IV/RO 100 AKG	9.04	V/RO 100	2.14
12.5 - 1/2	RO 125 AKG	24.57	EV/RO 125 AKG	IV/RO 125 AKG	9.04	V/RO 125	2.14

H = mm - in.	Double-leg outside corner, 90°	Double-leg inside corner, 90°	\$ / Unit
8 - 5/16	E2L/RO 80 AKG	I2L/RO 80 AKG	13.68
10 - 3/8	E2L/RO 100 AKG	I2L/RO 100 AKG	13.68
12.5 - 1/2	E2L/RO 125 AKG	I2L/RO 125 AKG	13.68



Schluter®-RONDEC							
Length = 2.5 m - 8' 2-1/2"	Brushed copper anod. alu. (AKGB)						
H = mm - in.	Profile	\$/ Length	Outside corner, 90°	Inside corner, 90°	\$/ Unit	Connector	\$/ Unit
6 - 1/4	RO 60 AKGB	19.78	EV/RO 60 AKGB	IV/RO 60 AKGB	15.58	V/RO 60	2.14
8 - 5/16	RO 80 AKGB	20.95	EV/RO 80 AKGB	IV/RO 80 AKGB	15.58	V/RO 80	2.14
10 - 3/8	RO 100 AKGB	22.31	EV/RO 100 AKGB	IV/RO 100 AKGB	15.58	V/RO 100	2.14
12.5 - 1/2	RO 125 AKGB	26.00	EV/RO 125 AKGB	IV/RO 125 AKGB	15.58	V/RO 125	2.14

H = mm - in.	Double-leg outside corner, 90°	Double-leg inside corner, 90°	\$/ Unit
8 - 5/16	E2L/RO 80 AKGB	I2L/RO 80 AKGB	16.88
10 - 3/8	E2L/RO 100 AKGB	I2L/RO 100 AKGB	16.88
12.5 - 1/2	E2L/RO 125 AKGB	I2L/RO 125 AKGB	16.88

Length = 2.5 m - 8' 2-1/2"	Brushed antique bronze anod. alu. (ABGB)						
H = mm - in.	Profile	\$/ Length	Outside corner, 90°	Inside corner, 90°	\$/ Unit	Connector	\$/ Unit
6 - 1/4	RO 60 ABGB	19.78	EV/RO 60 ABGB	IV/RO 60 ABGB	15.58	V/RO 60	2.14
8 - 5/16	RO 80 ABGB	20.95	EV/RO 80 ABGB	IV/RO 80 ABGB	15.58	V/RO 80	2.14
10 - 3/8	RO 100 ABGB	22.31	EV/RO 100 ABGB	IV/RO 100 ABGB	15.58	V/RO 100	2.14
12.5 - 1/2	RO 125 ABGB	26.00	EV/RO 125 ABGB	IV/RO 125 ABGB	15.58	V/RO 125	2.14

H = mm - in.	Double-leg outside corner, 90°	Double-leg inside corner, 90°	\$/ Unit
8 - 5/16	E2L/RO 80 ABGB	I2L/RO 80 ABGB	16.88
10 - 3/8	E2L/RO 100 ABGB	I2L/RO 100 ABGB	16.88
12.5 - 1/2	E2L/RO 125 ABGB	I2L/RO 125 ABGB	16.88

Length = 2.5 m - 8' 2-1/2"	Satin brass anod. alu. (AM)						
H = mm - in.	Profile	\$/ Length	Outside corner, 90°	Inside corner, 90°	\$/ Unit	Connector	\$/ Unit
6 - 1/4	RO 60 AM	15.86	EV/RO 60 AM	IV/RO 60 AM	7.76	V/RO 60	2.14
8 - 5/16	RO 80 AM	17.48	EV/RO 80 AM	IV/RO 80 AM	7.76	V/RO 80	2.14
10 - 3/8	RO 100 AM	18.55	EV/RO 100 AM	IV/RO 100 AM	7.76	V/RO 100	2.14
12.5 - 1/2	RO 125 AM	21.15	EV/RO 125 AM	IV/RO 125 AM	7.76	V/RO 125	2.14

H = mm - in.	Double-leg outside corner, 90°	Double-leg inside corner, 90°	\$/ Unit
8 - 5/16	E2L/RO 80 AM	I2L/RO 80 AM	13.55
10 - 3/8	E2L/RO 100 AM	I2L/RO 100 AM	13.55
12.5 - 1/2	E2L/RO 125 AM	I2L/RO 125 AM	13.55

Length = 2.5 m - 8' 2-1/2"	Polished brass anod. alu. (AMG)						
H = mm - in.	Profile	\$/ Length	Outside corner, 90°	Inside corner, 90°	\$/ Unit	Connector	\$/ Unit
6 - 1/4	RO 60 AMG	17.94	EV/RO 60 AMG	IV/RO 60 AMG	9.04	V/RO 60	2.14
8 - 5/16	RO 80 AMG	19.04	EV/RO 80 AMG	IV/RO 80 AMG	9.04	V/RO 80	2.14
10 - 3/8	RO 100 AMG	20.20	EV/RO 100 AMG	IV/RO 100 AMG	9.04	V/RO 100	2.14
12.5 - 1/2	RO 125 AMG	23.53	EV/RO 125 AMG	IV/RO 125 AMG	9.04	V/RO 125	2.14

H = mm - in.	Double-leg outside corner, 90°	Double-leg inside corner, 90°	\$/ Unit
8 - 5/16	E2L/RO 80 AMG	I2L/RO 80 AMG	13.55
10 - 3/8	E2L/RO 100 AMG	I2L/RO 100 AMG	13.55
12.5 - 1/2	E2L/RO 125 AMG	I2L/RO 125 AMG	13.55

Schluter®-RONDEC

Length = 2.5 m - 8' 2-1/2"		Brushed brass anod. alu. (AMGB)					
H = mm - in.	Profile	\$ / Length	Outside corner, 90°	Inside corner, 90°	\$ / Unit	Connector	\$ / Unit
6 - 1/4	RO 60 AMGB	19.39	EV/RO 60 AMGB	IV/RO 60 AMGB	15.58	V/RO 60	2.14
8 - 5/16	RO 80 AMGB	20.57	EV/RO 80 AMGB	IV/RO 80 AMGB	15.58	V/RO 80	2.14
10 - 3/8	RO 100 AMGB	21.88	EV/RO 100 AMGB	IV/RO 100 AMGB	15.58	V/RO 100	2.14
12.5 - 1/2	RO 125 AMGB	25.44	EV/RO 125 AMGB	IV/RO 125 AMGB	15.58	V/RO 125	2.14

H = mm - in.	Double-leg outside corner, 90°	Double-leg inside corner, 90°	\$ / Unit
8 - 5/16	E2L/RO 80 AMGB	I2L/RO 80 AMGB	17.04
10 - 3/8	E2L/RO 100 AMGB	I2L/RO 100 AMGB	17.04
12.5 - 1/2	E2L/RO 125 AMGB	I2L/RO 125 AMGB	17.04

Length = 2.5 m - 8' 2-1/2"		Graphite anod. alu. (AGR)					
H = mm - in.	Profile	\$ / Length	Outside corner, 90°	Inside corner, 90°	\$ / Unit	Connector	\$ / Unit
6 - 1/4	RO 60 AGR	17.66	EV/RO 60 AGR	IV/RO 60 AGR	8.04	V/RO 60	2.14
8 - 5/16	RO 80 AGR	19.45	EV/RO 80 AGR	IV/RO 80 AGR	8.04	V/RO 80	2.14
10 - 3/8	RO 100 AGR	20.65	EV/RO 100 AGR	IV/RO 100 AGR	8.04	V/RO 100	2.14
12.5 - 1/2	RO 125 AGR	23.54	EV/RO 125 AGR	IV/RO 125 AGR	8.04	V/RO 125	2.14

H = mm - in.	Double-leg outside corner, 90°	Double-leg inside corner, 90°	\$ / Unit
8 - 5/16	E2L/RO 80 AGR	I2L/RO 80 AGR	13.68
10 - 3/8	E2L/RO 100 AGR	I2L/RO 100 AGR	13.68
12.5 - 1/2	E2L/RO 125 AGR	I2L/RO 125 AGR	13.68

Length = 2.5 m - 8' 2-1/2"		Bright black anod. alu. (AGSG)					
H = mm - in.	Profile	\$ / Length	Outside corner, 90°	Inside corner, 90°	\$ / Unit	Connector	\$ / Unit
6 - 1/4	RO 60 AGSG	19.74	EV/RO 60 AGSG	IV/RO 60 AGSG	9.49	V/RO 60	2.14
8 - 5/16	RO 80 AGSG	20.96	EV/RO 80 AGSG	IV/RO 80 AGSG	9.49	V/RO 80	2.14
10 - 3/8	RO 100 AGSG	22.29	EV/RO 100 AGSG	IV/RO 100 AGSG	9.49	V/RO 100	2.14
12.5 - 1/2	RO 125 AGSG	25.99	EV/RO 125 AGSG	IV/RO 125 AGSG	9.49	V/RO 125	2.14

H = mm - in.	Double-leg outside corner, 90°	Double-leg inside corner, 90°	\$ / Unit
8 - 5/16	E2L/RO 80 AGSG	I2L/RO 80 AGSG	13.94
10 - 3/8	E2L/RO 100 AGSG	I2L/RO 100 AGSG	13.94
12.5 - 1/2	E2L/RO 125 AGSG	I2L/RO 125 AGSG	13.94

Length = 2.5 m - 8' 2-1/2"		Brushed black anod. alu. (AGSB)					
H = mm - in.	Profile	\$ / Length	Outside corner, 90°	Inside corner, 90°	\$ / Unit	Connector	\$ / Unit
6 - 1/4	RO 60 AGBS	20.76	EV/RO 60 AGBS	IV/RO 60 AGBS	16.02	V/RO 60	2.14
8 - 5/16	RO 80 AGBS	21.98	EV/RO 80 AGBS	IV/RO 80 AGBS	16.02	V/RO 80	2.14
10 - 3/8	RO 100 AGBS	23.40	EV/RO 100 AGBS	IV/RO 100 AGBS	16.02	V/RO 100	2.14
12.5 - 1/2	RO 125 AGBS	27.27	EV/RO 125 AGBS	IV/RO 125 AGBS	16.02	V/RO 125	2.14

H = mm - in.	Double-leg outside corner, 90°	Double-leg inside corner, 90°	\$ / Unit
8 - 5/16	E2L/RO 80 AGBS	I2L/RO 80 AGBS	16.88
10 - 3/8	E2L/RO 100 AGBS	I2L/RO 100 AGBS	16.88
12.5 - 1/2	E2L/RO 125 AGBS	I2L/RO 125 AGBS	16.88



Schluter®-TRENDLINE Textured Color-coated Aluminum

Schluter®-RONDEC							
Length = 2.5 m - 8' 2-1/2"		Textured color-coated aluminum (TS)					
H = mm - in.	Profile	\$/ Length	Outside corner, 90°	Inside corner, 90°	\$/ Unit	Connector	\$/ Unit
6 - 1/4	RO 60 + color*	38.98	EV/RO 60 + color*	IV/RO 60 + color*	13.89	V/RO 60	2.14
8 - 5/16	RO 80 + color*	39.77	EV/RO 80 + color*	IV/RO 80 + color*	13.89	V/RO 80	2.14
10 - 3/8	RO 100 + color*	41.08	EV/RO 100 + color*	IV/RO 100 + color*	13.89	V/RO 100	2.14
11 - 7/16	RO 110 + color*	41.53	EV/RO 110 + color*	IV/RO 110 + color*	13.89	V/RO 110	2.14
12.5 - 1/2	RO 125 + color*	41.95	EV/RO 125 + color*	IV/RO 125 + color*	13.89	V/RO 125	2.14



*Color Codes							
	TSR Rustic brown		TSDA Dark anthracite		TSLA Light anthracite		TSSG Stone grey
	TSC Cream		TSBG Greige		TSI Ivory		TSB Beige
	TSOB Bronze		TSG Pewter				

* To complete the item number, add the **color** code (e.g., RO 60 **TSC**).

Matte White and Matte Black

Textured color-coated aluminum							
Length = 2.5 m - 8' 2-1/2"		Textured color-coated aluminum					
H = mm - in.	Profile	\$/ Length	Outside corner, 90°	Inside corner, 90°	\$/ Unit	Connector	\$/ Unit
6 - 1/4	RO 60 + color*	31.19	ED/RO 60 + color*	ID/RO 60 + color*	9.72	V/RO 60	2.14
8 - 5/16	RO 80 + color*	31.82	ED/RO 80 + color*	ID/RO 80 + color*	9.72	V/RO 80	2.14
10 - 3/8	RO 100 + color*	32.87	ED/RO 100 + color*	ID/RO 100 + color*	9.72	V/RO 100	2.14
11 - 7/16	RO 110 + color*	33.22	ED/RO 110 + color*	ID/RO 110 + color*	9.72	V/RO 110	2.14
12.5 - 1/2	RO 125 + color*	33.56	ED/RO 125 + color*	ID/RO 125 + color*	9.72	V/RO 125	2.14

*Color Codes	
	MGS Matte black
	MBW Matte white

* To complete the item number, add the **color** code (e.g., RO 60 **MGS**).

Color-coated Aluminum

Color-coated aluminum (AC)							
Length = 2.5 m - 8' 2-1/2"		Color-coated aluminum (AC)					
H = mm - in.	Profile	\$/ Length	Outside corner, 90°	Inside corner, 90°	\$/ Unit	Connector	\$/ Unit
6 - 1/4	RO 60 + color*	17.56	ED/RO 60 + color*	ID/RO 60 + color*	4.66	V/RO 60	2.14
8 - 5/16	RO 80 + color*	19.74	ED/RO 80 + color*	ID/RO 80 + color*	4.66	V/RO 80	2.14
10 - 3/8	RO 100 + color*	22.24	ED/RO 100 + color*	ID/RO 100 + color*	4.66	V/RO 100	2.14
12.5 - 1/2	RO 125 + color*	27.04	ED/RO 125 + color*	ID/RO 125 + color*	4.66	V/RO 125	2.14

PVC

PVC (P)							
Length = 2.5 m - 8' 2-1/2"		PVC (P)					
H = mm - in.	Profile	\$/ Length	Outside corner, 90°	Inside corner, 90°	\$/ Unit	Connector	\$/ Unit
6 - 1/4	PRO 60 + color*	6.52	E/PRO 60 + color*	I/PRO 60 + color*	2.48		
8 - 5/16	PRO 80 + color*	6.63	E/PRO 80 + color*	I/PRO 80 + color*	2.48		
10 - 3/8	PRO 100 + color*	7.07	E/PRO 100 + color*	I/PRO 100 + color*	2.48		
11 - 7/16	PRO 110 + color*	7.61	E/PRO 110 + color*	I/PRO 110 + color*	2.48		
12.5 - 1/2	PRO 125 + color*	7.93	E/PRO 125 + color*	I/PRO 125 + color*	2.48		

*Color Codes (Color-coated Aluminum and PVC)											
	BW Bright white		W White		SP Sand pebble		BH Bahama		HB Light beige		HG Light grey
	PG Classic grey		G Grey		GS Black		GM Metallic grey		SB Black brown		

* To complete the item number, add the **color** code (e.g., RO 60 **G**). GM & SB are only available in color-coated aluminum



Schluter®-QUADEC

Schluter®-QUADEC is a finishing and edge-protection profile for tiled edges and outside corners of tiled surfaces. The reveal of the profile forms a square outer corner along the surface edge. QUADEC can also be used as an accent within tile fields on both floors and walls. QUADEC allows for modern decorative design and interesting contrasts. The profile can be combined with the Schluter®-QUADEC-FS (page 38) feature strip profile and/or the Schluter®-DESIGNLINE border profile for further design options (page 42). QUADEC, in stainless steel, can also be used as a stair nosing or floor transition profile. QUADEC in aluminum and PVC feature an integrated joint spacer that establishes a defined joint cavity between the tile and the profile.

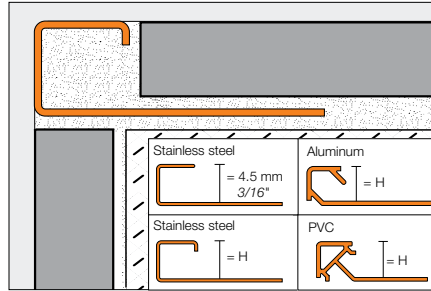

Inside/outside corner/end cap (EV/)



Note: Also available in chrome-plated brass, and stainless steel 316L (1.4404 = V4A). Contact Customer Service for pricing and availability.

Stainless Steel 304 (1.4301 = V2A)

Schluter®-QUADEC						
Length = 2.5 m - 8' 2-1/2"	Stainless steel 304 (1.4301 = V2A) (E)					
H = mm - in.	Profile	\$/ Length	Inside/outside corner	\$/ Unit	Connector	\$/ Unit
4.5 - 3/16	Q 45 E	43.82	EV/Q 45 E	32.52	-	-
6 - 1/4	Q 60 E	52.78	EV/Q 60 E	37.02	V/RO 60 E	5.07
▲ 7 - 9/32	Q 70 E	54.60	EV/Q 70 E	37.02	-	-
8 - 5/16	Q 80 E	57.04	EV/Q 80 E	37.02	V/RO 80 E	5.07
9 - 11/32	Q 90 E	59.31	EV/Q 90 E	37.02	-	-
10 - 3/8	Q 100 E	61.26	EV/Q 100 E	42.71	V/RO 100 E	5.07
11 - 7/16	Q 110 E	62.49	EV/Q 110 E	42.71	V/RO 110 E	5.07
12.5 - 1/2	Q 125 E	63.15	EV/Q 125 E	42.71	V/RO 125 E	5.07
14 - 17/32	Q 140 E	64.41	EV/Q 140 E	43.56	-	-
15 - 9/16	Q 150 E	65.70	EV/Q 150 E	44.10	-	-

Length = 2.5 m - 8' 2-1/2"	Brushed stainless steel 304 (1.4301 = V2A) (EB)					
H = mm - in.	Profile	\$/ Length	Inside/outside corner	\$/ Unit	Connector	\$/ Unit
6 - 1/4	Q 60 EB	79.07	EV/Q 60 EB	40.47	V/RO 60 E	5.07
▲ 7 - 9/32	Q 70 EB	80.33	EV/Q 70 EB	40.47	-	-
8 - 5/16	Q 80 EB	82.62	EV/Q 80 EB	40.47	V/RO 80 E	5.07
9 - 11/32	Q 90 EB	84.27	EV/Q 90 EB	40.47	-	-
10 - 3/8	Q 100 EB	86.30	EV/Q 100 EB	44.04	V/RO 100 E	5.07
11 - 7/16	Q 110 EB	88.20	EV/Q 110 EB	44.04	V/RO 110 E	5.07
12.5 - 1/2	Q 125 EB	90.07	EV/Q 125 EB	44.04	V/RO 125 E	5.07
14 - 17/32	Q 140 EB	91.88	EV/Q 140 EB	44.92	-	-
15 - 9/16	Q 150 EB	93.71	EV/Q 150 EB	46.20	-	-



Stainless Steel 304 (1.4301 = V2A)

Schluter®-QUADEC					
Length = 2.5 m - 8' 2-1/2"		Stainless steel 304 (1.4301 = V2A) square check (ES1)			
H = mm - in.	Profile	\$ / Length	Connector	\$ / Unit	
8 - 5/16	Q 80 ES1	57.04	V/RO 80 E	5.07	
10 - 3/8	Q 100 ES1	61.26	V/RO 100 E	5.07	
11 - 7/16	Q 110 ES1	62.49	V/RO 110 E	5.07	
12.5 - 1/2	Q 125 ES1	63.15	V/RO 125 E	5.07	

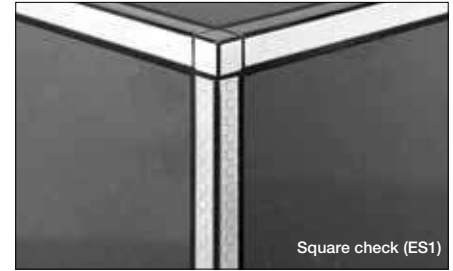

Schluter®-QUADEC					
Length = 2.5 m - 8' 2-1/2"		Stainless steel 304 (1.4301 = V2A) leather texture (ES2)			
H = mm - in.	Profile	\$ / Length	Connector	\$ / Unit	
8 - 5/16	Q 80 ES2	57.04	V/RO 80 E	5.07	
10 - 3/8	Q 100 ES2	61.26	V/RO 100 E	5.07	
11 - 7/16	Q 110 ES2	62.49	V/RO 110 E	5.07	
12.5 - 1/2	Q 125 ES2	63.15	V/RO 125 E	5.07	

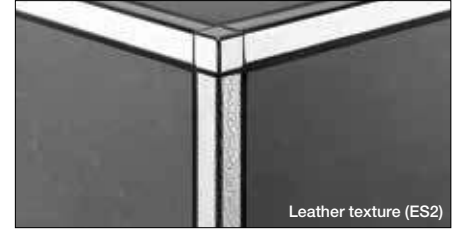

Note: QUADEC corners in stainless steel are recommended for use with square check and leather texture finishes.

Anodized Aluminum

Schluter®-QUADEC											
Length = 2.5 m - 8' 2-1/2"		Satin anodized aluminum (AE)				Polished chrome anod. alu. (ACG)				Connector	
H = mm - in.	Profile	\$ / Length	Inside/outside corner	\$ / Unit	Profile	\$ / Length	Inside/outside corner	\$ / Unit	Item No.	\$ / Unit	
4.5 - 3/16	Q 45 AE	16.74	EV/Q 45 AE	8.61	Q 45 ACG	18.00	EV/Q 45 ACG	9.03	-	-	
6 - 1/4	Q 60 AE	17.08	EV/Q 60 AE	8.61	Q 60 ACG	18.74	EV/Q 60 ACG	9.03	V/Q 60	2.14	
8 - 5/16	Q 80 AE	18.88	EV/Q 80 AE	8.61	③ Q 80 ACG	20.90	EV/Q 80 ACG	9.03	V/RO 80	2.14	
10 - 3/8	Q 100 AE	19.67	EV/Q 100 AE	8.61	③ Q 100 ACG	23.02	EV/Q 100 ACG	9.03	V/RO 100	2.14	
12.5 - 1/2	Q 125 AE	23.16	EV/Q 125 AE	8.61	③ Q 125 ACG	26.97	EV/Q 125 ACG	9.03	V/RO 125	2.14	
15 - 9/16	Q 150 AE	25.37	EV/Q 150 AE	9.45	-	-	-	-	-	-	
20 - 3/4	Q 200 AE	27.77	EV/Q 200 AE	9.45	-	-	-	-	-	-	

Length = 2.5 m - 8' 2-1/2"		Satin nickel anod. alu. (AT)				Brushed antique bronze anod. alu. (ABGB)				Connector	
H = mm - in.	Profile	\$ / Length	Inside/outside corner	\$ / Unit	Profile	\$ / Length	Inside/outside corner	\$ / Unit	Item No.	\$ / Unit	
4.5 - 3/16	Q 45 AT	17.97	EV/Q 45 AT	8.54	-	-	-	-	-	-	
6 - 1/4	Q 60 AT	18.71	EV/Q 60 AT	8.54	Q 60 ABGB	19.91	EV/Q 60 ABGB	12.16	V/Q 60	2.14	
8 - 5/16	Q 80 AT	20.62	EV/Q 80 AT	8.54	Q 80 ABGB	20.33	EV/Q 80 ABGB	12.16	V/RO 80	2.14	
10 - 3/8	Q 100 AT	21.88	EV/Q 100 AT	8.54	Q 100 ABGB	22.62	EV/Q 100 ABGB	12.16	V/RO 100	2.14	
12.5 - 1/2	Q 125 AT	24.95	EV/Q 125 AT	8.54	Q 125 ABGB	24.43	EV/Q 125 ABGB	12.16	V/RO 125	2.14	

③ Available in 10' (3.05 m) length. Please refer to page 22.



Schluter®-TRENDLINE Textured Color-coated Aluminum

Schluter®-QUADEC						
Length = 2.5 m - 8' 2-1/2"	Textured color-coated aluminum (TS)					
H = mm - in.	Profile	\$/ Length	Inside/outside corner	\$/ Unit	Connector	\$/ Unit
4.5 - 3/16	Q 45 + color*	38.56	EV/Q 45 + color*	15.41	-	-
6 - 1/4	Q 60 + color*	39.35	EV/Q 60 + color*	15.41	V/Q 60	2.14
8 - 5/16	Q 80 + color*	40.15	EV/Q 80 + color*	15.41	V/RO 80	2.14
10 - 3/8	Q 100 + color*	41.24	EV/Q 100 + color*	15.41	V/RO 100	2.14
11 - 7/16	Q 110 + color*	41.79	EV/Q 110 + color*	15.41	V/RO 110	2.14
12.5 - 1/2	Q 125 + color*	42.22	EV/Q 125 + color*	15.41	V/RO 125	2.14



*Color Codes



* To complete the item number, add the **color** code (e.g., Q 60 **TSC**).

Matte White and Matte Black

Length = 2.5 m - 8' 2-1/2"	Textured color-coated aluminum					
H = mm - in.	Profile	\$/ Length	Outside corner	\$/ Unit	Connector	\$/ Unit
4.5 - 3/16	Q 45 + color*	30.56	ED/Q 45 + color*	9.72	-	-
6 - 1/4	Q 60 + color*	31.19	ED/Q 60 + color*	9.72	V/Q 60	2.14
8 - 5/16	Q 80 + color*	31.82	ED/Q 80 + color*	9.72	V/RO 80	2.14
10 - 3/8	Q 100 + color*	32.87	ED/Q 100 + color*	9.72	V/RO 100	2.14
11 - 7/16	Q 110 + color*	33.22	ED/Q 110 + color*	9.72	V/RO 110	2.14
12.5 - 1/2	Q 125 + color*	33.56	ED/Q 125 + color*	9.72	V/RO 125	2.14

*Color Codes



* To complete the item number, add the **color** code (e.g., Q 60 **MGS**).





QUADEC
in color-coated
aluminum and
PVC

Color-coated Aluminum

Schluter®-QUADEC				
Length = 2.5 m - 8' 2-1/2"	▲ Color-coated aluminum (AC)			
H = mm - in.	Profile	\$ / Length	Outside corner, 90°	\$ / Unit
4.5 - 3/16	Q 45 + color*	16.30	ED/Q 45 + color*	4.66
6 - 1/4	Q 60 + color*	17.56	ED/Q 60 + color*	4.66
8 - 5/16	Q 80 + color*	19.74	ED/Q 80 + color*	4.66
10 - 3/8	Q 100 + color*	22.24	ED/Q 100 + color*	4.66
11 - 7/16	Q 110 + color*	23.63	ED/Q 110 + color*	4.66
12.5 - 1/2	Q 125 + color*	27.04	ED/Q 125 + color*	4.66

***Color Codes**

BW Bright white	W White	SP Sand pebble	PG Classic grey
QG Quartz grey	VG Traffic grey	SB Black brown	GS Black

* To complete the item number, add the color code (e.g., Q 45 **G**).

PVC

Schluter®-QUADEC				
Length = 2.5 m - 8' 2-1/2"	▲ PVC (P)			
H = mm - in.	Profile	\$ / Length	Outside corner, 90°	\$ / Unit
6 - 1/4	PQ 60 + color*	7.92	E/PQ 60 + color*	2.48
8 - 5/16	PQ 80 + color*	8.32	E/PQ 80 + color*	2.48
10 - 3/8	PQ 100 + color*	8.88	E/PQ 100 + color*	2.48
11 - 7/16	PQ 110 + color*	10.00	E/PQ 110 + color*	2.48
12.5 - 1/2	PQ 125 + color*	11.11	E/PQ 125 + color*	2.48

***Color Codes**

BW Bright white	W White	SP Sand pebble	BH Bahama
HB Light beige	HG Light grey	PG Classic grey	G Grey
GS Black			

* To complete the item number, add the color code (e.g., PQ 80 **PG**).



Schluter®-QUADEC-K

Schluter®-QUADEC-K is a variant of the QUADEC profile without an anchoring leg. It features an open cavity that is filled with thin-set mortar to secure the profile in the assembly. Alternatively, the profile may be installed with an adhesive such as Schluter®-KERDI-FIX. QUADEC-K is installed in wall applications (e.g., wainscotings and bases) with coverings up to 1/2" (12.5 mm) thick. The profile is particularly suited for finishing edges in retrofit applications, such as thin porcelain panel installation over existing wall tiles.

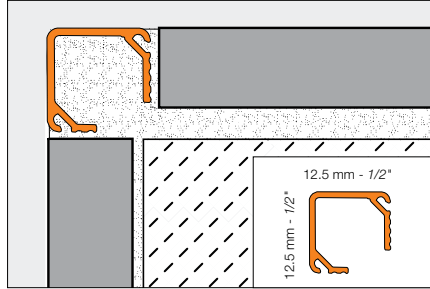

Schluter®-QUADEC-K												
Length = 2.5 m - 8' 2-1/2"	Satin anodized aluminum (AE)						Polished chrome anod. alu. (ACG)					
H = mm - in.	Profile	\$ / Length	Inside/outside corner	\$ / Unit	Connector	\$ / Unit	Profile	\$ / Length	Inside/outside corner	\$ / Unit	Connector	\$ / Unit
12.5 - 1/2	Q 125 AE K	18.90	EV/Q 125 AE	8.61	V/RO 125	2.14	Q 125 ACG K	22.31	EV/Q 125 ACG	9.03	V/RO 125	2.14
Length = 2.5 m - 8' 2-1/2"	Satin nickel anod. alu. (AT)						Brushed antique bronze anod. alu. (ABGB)					
H = mm - in.	Profile	\$ / Length	Inside/outside corner	\$ / Unit	Connector	\$ / Unit	Profile	\$ / Length	Inside/outside corner	\$ / Unit	Connector	\$ / Unit
12.5 - 1/2	Q 125 AT K	20.65	EV/Q 125 AT	8.54	V/RO 125	2.14	Q 125 ABGB K	24.41	EV/Q 125 ABGB	12.16	V/RO 125	2.14

Schluter®-QUADEC-FS

Schluter®-QUADEC-FS is a double-rail feature strip profile that features a recessed section to which field or accent tile is bonded. The profile can be used to produce accents in tile fields on walls, chair rails, and various other decorative applications. The profile can be combined with the Schluter®-QUADEC (page 34) finishing and edge-protection profile. QUADEC-FS features integrated joint spacers that establish defined joint cavities between the accent tile and the profile.

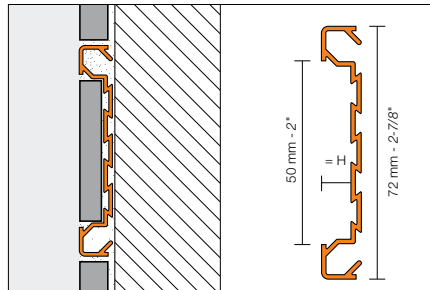

Inside/outside corner /
End cap (EV)



Note: The universal accessory piece can be used to produce a 90° inside corner, 90° outside corner, and end cap.

Schluter®-QUADEC-FS								
Length = 2.5 m - 8' 2-1/2"	Satin anodized aluminum (AE)				Polished chrome anod. alu. (ACG)			
H = mm - in.	Profile	\$ / Length	Inside/outside corner	\$ / Unit	Profile	\$ / Length	Inside/outside corner	\$ / Unit
8 - 5/16	QF8/50 AE	31.72	EV/QF8/50 AE	23.01	QF8/50 ACG	37.43	EV/QF8/50 ACG	24.84
Length = 2.5 m - 8' 2-1/2"	Satin nickel anod. alu. (AT)				Brushed antique bronze anod. alu. (ABGB)			
H = mm - in.	Profile	\$ / Length	Inside/outside corner	\$ / Unit	Profile	\$ / Length	Inside/outside corner	\$ / Unit
8 - 5/16	QF8/50 AT	33.58	EV/QF8/50 AT	23.01	QF8/50 ABGB	43.52	EV/QF8/50 ABGB	25.99



Schluter®-DIADEC

Schluter®-DIADEC is a finishing and edge-protection profile for tiled edges and outside corners of tiled surfaces. The reveal of the profile forms a 45° beveled edge. DIADEC features integrated joint spacers that establish defined joint cavities between the tile and the profile. It is particularly suited for finishing edges in retrofit applications, such as tile installation over existing wall tiles.

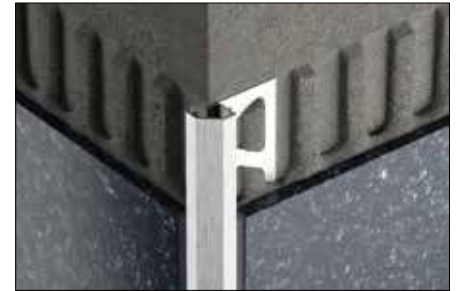
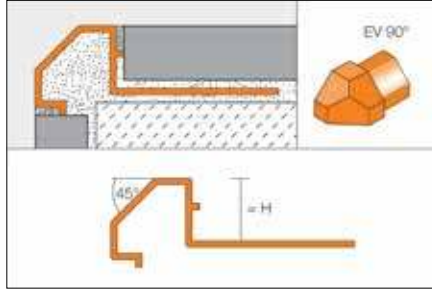

Outside corner 90°

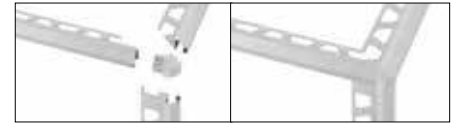

Note: The outside corner piece can be used with any size of the DIADEC profile.

Schluter®-DIADEC						
Length = 2.5 m - 8' 2-1/2"	Satin anodized aluminum (AE)		Polished chrome anod. alu. (ACG)		Brushed chrome anod. alu. (ACGB)	
	Profile	\$ / Length	Profile	\$ / Length	Profile	\$ / Length
H = mm - in.						
8 - 5/16	DI 80 AE 18	26.44	DI 80 ACG 18	43.93	DI 80 ACGB 18	33.21
10 - 3/8	DI 100 AE 18	26.78	DI 100 ACG 18	44.37	DI 100 ACGB 18	33.41
11 - 7/16	DI 110 AE 18	27.59	DI 110 ACG 18	44.71	DI 110 ACGB 18	33.75
12.5 - 1/2	DI 125 AE 18	28.14	DI 125 ACG 18	45.03	DI 125 ACGB 18	34.08

Satin anodized aluminum (AE)	Polished chrome anod. alu. (ACG)	Brushed chrome anod. alu. (ACGB)	\$ / Unit
Outside corner 90°	Outside corner 90°	Outside corner 90°	
EV/DI 518 AE	EV/DI 518 ACG	EV/DI 518 ACGB	38.91

Schluter®-DIADEC-K

Schluter®-DIADEC-K a variant of the DIADEC profile without an anchoring leg. The reveal of the profile forms a 45° beveled edge. The profile features an open cavity that is filled with thin-set mortar to secure the profile in the assembly with tiles at least 1/4" (6 mm) thick. It is particularly suited for finishing edges in retrofit applications, such as tile installation over existing wall tiles.

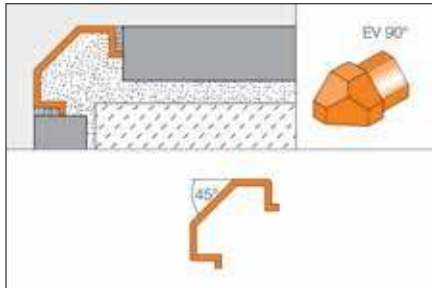

Outside corner 90°

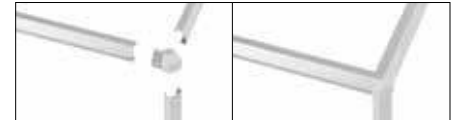

Schluter®-DIADEC-K						
Length = 2.5 m - 8' 2-1/2"	Satin anodized aluminum (AE)		Polished chrome anod. alu. (ACG)		Brushed chrome anod. alu. (ACGB)	
	Profile	\$ / Length	Profile	\$ / Length	Profile	\$ / Length
	DI 518 AE	29.76	DI 518 ACG	39.22	DI 518 ACGB	41.06

Satin anodized aluminum (AE)	Polished chrome anod. alu. (ACG)	Brushed chrome anod. alu. (ACGB)	\$ / Unit
Outside corner 90°	Outside corner 90°	Outside corner 90°	
EV/DI 518 AE	EV/DI 518 ACG	EV/DI 518 ACGB	38.91



FINEC
A tile trim with a minimalist design

Schluter®-FINEC

Schluter®-FINEC is a finishing and edge-protection profile for the external edges of tile coverings or mosaics. The finishing leg of the profile protects the covering edges from mechanical damage, and features a very slim, elegant reveal. Available in anodized aluminium in all TRENDLINE colors as well as stainless steel, FINEC is ideal for protecting mitered edges, while creating a discreet trim for a minimalist design.

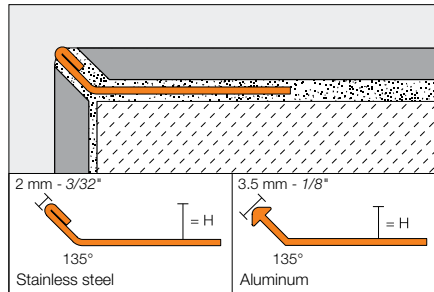

Schluter®-FINEC				
Length = 2.5 m - 8' 2-1/2"	Stainless steel 304 (1.4301 = V2A) (E)		Satin anodized aluminum (AE)	
H = mm - in.	Item No.	\$ / Length	Item No.	\$ / Length
2.5 - 3/32	-	-	F 25 AE	17.72
4.5 - 3/16	F 45 E	34.67	F 45 AE	17.85
7 - 9/32	F 70 E	36.38	F 70 AE	18.69
9 - 11/32	F 90 E	38.29	F 90 AE	19.43
11 - 7/16	F 110 E	39.32	F 110 AE	20.06
12.5 - 1/2	F 125 E	39.92	F 125 AE	20.48

Length = 2.5 m - 8' 2-1/2"	Textured & matte color-coated aluminum		
H = mm - in.	Item No.	\$ / Length	
2.5 - 3/32	F 25 MBW	23.69	
4.5 - 3/16	F 45 + color*	24.18	
7 - 9/32	F 70 + color*	24.68	
9 - 11/32	F 90 + color*	25.71	
11 - 7/16	F 110 + color*	25.98	
12.5 - 1/2	F 125 + color*	26.48	

***Color Codes**

TSR Rustic brown	TSDA Dark anthracite	TSLA Light anthracite	TSSG Stone grey
TSC Cream	TSBG Greige	TSI Ivory	TSB Beige
TSOB Bronze	TSG Pewter	MGS Matte black	MBW Matte white

* To complete the item number, add the color code (e.g., F 70 TSC).



Schluter®-INDEC

Schluter®-INDEC is an anodized aluminum profile for outside corners of tiled surfaces and tiled edges. The reveal of the profile forms a square recessed groove for modern decorative design and interesting contrasts.

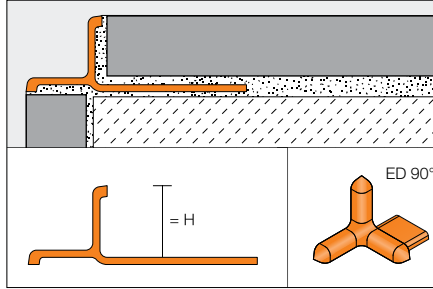

Schluter®-INDEC								
Length = 2.5 m - 8' 2-1/2"	Satin anodized aluminum (AE)		Cast zinc with AE appearance		Polished chrome anod. alu. (ACG)		Cast zinc with ACG appearance	
H = mm - in.	Profile	\$/ Length	Outside corner 90°	\$/ Unit	Profile	\$/ Length	Outside corner 90°	\$/ Unit
8 - 5/16	IN 80 AE	23.78	ED / IN 80 AE	6.45	IN 80 ACG	41.75	ED / IN 80 ACG	6.45
10 - 3/8	IN 100 AE	24.56	ED / IN 100 AE	6.45	IN 100 ACG	42.87	ED / IN 100 ACG	6.45
11 - 7/16	IN 110 AE	25.34	ED / IN 110 AE	6.45	IN 110 ACG	45.45	ED / IN 110 ACG	6.45
12.5 - 1/2	IN 125 AE	29.79	ED / IN 125 AE	6.45	IN 125 ACG	48.48	ED / IN 125 ACG	6.45

Schluter®-RONDEC-DB

Schluter®-RONDEC-DB is a decorative profile for walls, wainscotings, and tile bases. The profile produces a pronounced visible surface that establishes a clean line along tile edges and allows for decorative design. RONDEC-DB can also be used as a finishing profile within wall surfaces. RONDEC-DB features an integrated joint spacer that establishes a defined joint cavity between the tile and the profile.

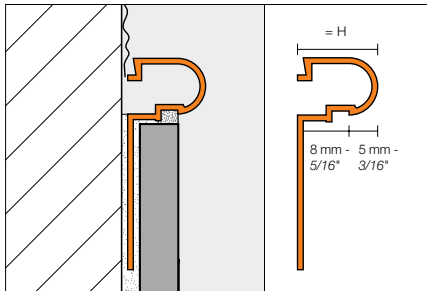

Outside corner (90°)

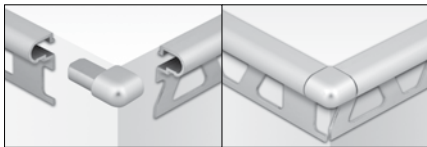

Schluter®-RONDEC-DB								
Length = 2.5 m - 8' 2-1/2"	Satin anodized aluminum (AE)				Satin copper anod. alu. (AK)		Satin brass anod. alu. (AM)	
H = mm - in.	Item No.	\$/ Length	Outside corner, 90°	\$/ Unit	Item No.	\$/ Length	Item No.	\$/ Length
14 - 17/32	DB 14 AE	35.13	EV/DB 14 AE	12.35	DB 14 AK	37.29	DB 14 AM	35.13

3 Available in 10' (3.05 m) length. Please refer to page 22.



Schluter®-DESIGNLINE

Schluter®-DESIGNLINE is a border profile for producing decorative designs in tile fields on walls. DESIGNLINE in stainless steel can also be used to produce decorative designs in floors. The profile can be combined with Schluter®-QUADEC (page 34) and Schluter®-RONDEC (page 27) finishing and edge-protection profiles. DESIGNLINE in anodized aluminum features an integrated joint spacer that establishes a defined joint cavity between the tile and the profile.

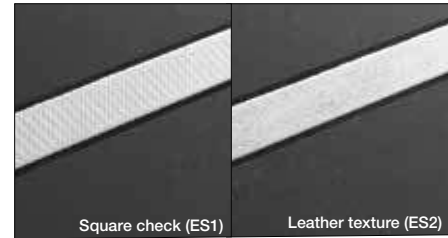
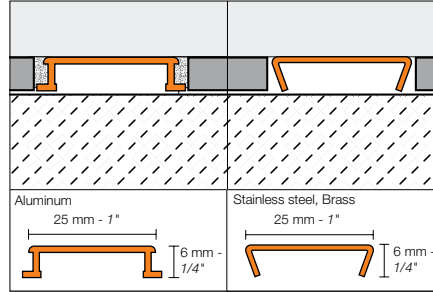

Schluter®-DESIGNLINE										
Length = 2.5 m - 8' 2-1/2"	Stainless steel 304 (1.4301 = V2A) (E)		Brushed stainless steel 304 (1.4301 = V2A) (EB)		Stainless steel 304 (1.4301 = V2A) square check (ES1)		Stainless steel 304 (1.4301 = V2A) leather texture (ES2)			
H = mm - in.	Item No.	\$ / Length	Item No.	\$ / Length	Item No.	\$ / Length	Item No.	\$ / Length	Item No.	\$ / Length
6 - 1/4	DL 625 E	67.07	DL 625 EB	98.01	DL 625 ES1	67.07	DL 625 ES2	67.07		
Length = 2.5 m - 8' 2-1/2"	Chrome-plated solid brass (MC)		Satin anodized aluminum (AE)		Polished chrome anod. alu. (ACG)		Brushed chrome anod. alu. (ACGB)		Satin nickel anod. alu. (AT)	
H = mm - in.	Item No.	\$ / Length	Item No.	\$ / Length	Item No.	\$ / Length	Item No.	\$ / Length	Item No.	\$ / Length
6 - 1/4	DL 625 MC	107.56	DL 625 AE	27.73	DL 625 ACG	38.12	DL 625 ACGB	43.66	DL 625 AT	29.18
Length = 2.5 m - 8' 2-1/2"	Polished nickel anod. alu. (ATG)		Brushed nickel anod. alu. (ATGB)		Satin copper anod. alu. (AK)		Polished copper anod. alu. (AKG)		Brushed copper anod. alu. (AKGB)	
H = mm - in.	Item No.	\$ / Length	Item No.	\$ / Length	Item No.	\$ / Length	Item No.	\$ / Length	Item No.	\$ / Length
6 - 1/4	DL 625 ATG	39.56	DL 625 ATGB	45.10	DL 625 AK	29.18	DL 625 AKG	39.56	DL 625 AKGB	45.10
Length = 2.5 m - 8' 2-1/2"	Satin brass anod. alu. (AM)		Polished brass anod. alu. (AMG)		Brushed brass anod. alu. (AMGB)					
H = mm - in.	Item No.	\$ / Length	Item No.	\$ / Length	Item No.	\$ / Length				
6 - 1/4	DL 625 AM	27.73	DL 625 AMG	38.12	DL 625 AMGB	43.66				



Schluter®-DECO-DE

Schluter®-DECO-DE is a stainless steel finishing and edge-protection profile for 135° outside corners of tiled surfaces.

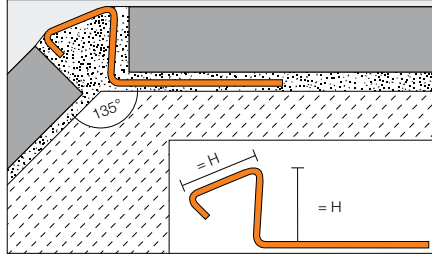

Schluter®-DECO-DE				
Length = 2.5 m - 8' 2-1/2"	Stainless steel 304 (1.4301 = V2A) (E)		Brushed stainless steel 304 (1.4301 = V2A) (EB)	
H = mm - in.	Item No.	\$ / Length	Item No.	\$ / Length
8 - 5/16	DE 80 ES	40.48	DE 80 EBS	44.68
10 - 3/8	DE 100 ES	42.53	DE 100 EBS	47.02
11 - 7/16	DE 110 ES	43.26	DE 110 EBS	48.14
12.5 - 1/2	DE 125 ES	44.48	DE 125 EBS	49.75

Schluter®-DECO-SG

Schluter®-DECO-SG is a decorative profile featuring a 1/2" (12.5 mm) or 9/16" (15 mm) wide channel that creates a shadow gap between tile courses or other wall covering. The profile may also be used as a support channel for glass walls. The 1/2" wide channel accommodates glass walls up to a thickness of 3/8" (10 mm), and the 9/16" wide channel accommodates glass walls up to a thickness of 1/2" (12.5 mm). DECO-SG features a trapezoid-perforated anchoring leg that is secured in the bond coat beneath the tile.

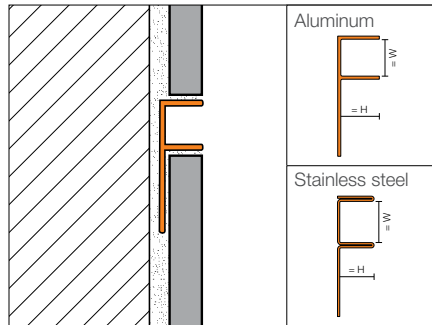

Schluter®-DECO-SG						
Length = 2.5 m - 8' 2-1/2"	▲ Brushed stainless steel 304 (1.4301 = V2A) (EB)		Satin anodized aluminum (AE)		Bright chrome anod. alu. (ACB)	
H = mm - in.	Item No.	\$ / Length	Item No.	\$ / Length	Item No.	\$ / Length
W: 12.5 mm - 1/2"						
8 - 5/16	SG 80 EB 12	69.54	SG 80 AE 12	19.01	SG 80 ACB 12	19.79
10 - 3/8	SG 100 EB 12	74.68	SG 100 AE 12	20.00	SG 100 ACB 12	20.69
11 - 7/16	SG 110 EB 12	77.54	SG 110 AE 12	20.53	SG 110 ACB 12	21.32
12.5 - 1/2	SG 125 EB 12	81.56	SG 125 AE 12	21.26	SG 125 ACB 12	22.05
▲ W: 15 mm - 9/16"						
8 - 5/16	SG 80 EB 15	71.69	SG 80 AE 15	19.96	SG 80 ACB 15	20.78
10 - 3/8	SG 100 EB 15	76.61	SG 100 AE 15	21.00	SG 100 ACB 15	21.72
11 - 7/16	SG 110 EB 15	79.94	SG 110 AE 15	21.56	SG 110 ACB 15	22.39
12.5 - 1/2	SG 125 EB 15	83.24	SG 125 AE 15	22.32	SG 125 ACB 15	23.15



Schluter®-RONDEC-STEP

Schluter®-RONDEC-STEP is a finishing and edging profile for ceramic tile and dimension stone installations on countertops and stairs. The top of the profile features a symmetrically rounded edge that matches the Schluter®-RONDEC profile (page 27), while the vertical leg of the profile hides the exposed edge of the sub-assembly. RONDEC-STEP features an integrated joint spacer that establishes a defined joint cavity between the tile and the profile.

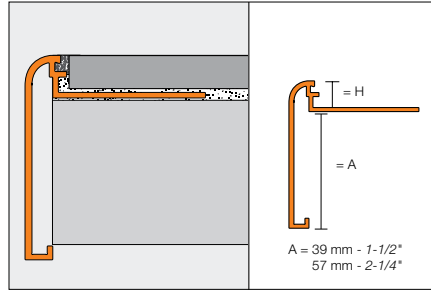

Outside corner (90° or 135°)



Inside corner (90° or 135°)



Schluter®-RONDEC-STEP							
Length = 2.5 m - 8' 2-1/2"	Satin anodized aluminum (AE)						
H = mm - in.	Profile	\$ / Length	Outside corner, 90°	Outside corner, 135°	Inside corner, 90°	Inside corner, 135°	\$ / Unit
A: 39 mm - 1-1/2"							
8 - 5/16	RS 80 AE 39	41.91	E90 RS 80 AE 39	E135 RS 80 AE 39	I90 RS 80 AE 39	I135 RS 80 AE 39	20.72
10 - 3/8	RS 100 AE 39	42.60	E90 RS 100 AE 39	E135 RS 100 AE 39	I90 RS 100 AE 39	I135 RS 100 AE 39	20.72
12.5 - 1/2	RS 125 AE 39	44.53	E90 RS 125 AE 39	E135 RS 125 AE 39	I90 RS 125 AE 39	I135 RS 125 AE 39	20.72
A: 57 mm - 2-1/4"							
8 - 5/16	RS 80 AE 57	42.77	E90 RS 80 AE 57	E135 RS 80 AE 57	I90 RS 80 AE 57	I135 RS 80 AE 57	20.72
10 - 3/8	RS 100 AE 57	43.47	E90 RS 100 AE 57	E135 RS 100 AE 57	I90 RS 100 AE 57	I135 RS 100 AE 57	20.72
12.5 - 1/2	RS 125 AE 57	45.43	E90 RS 125 AE 57	E135 RS 125 AE 57	I90 RS 125 AE 57	I135 RS 125 AE 57	20.72

Length = 2.5 m - 8' 2-1/2"	Brushed chrome anod. alu. (ACGB)						
H = mm - in.	Profile	\$ / Length	Outside corner, 90°	Outside corner, 135°	Inside corner, 90°	Inside corner, 135°	\$ / Unit
A: 39 mm - 1-1/2"							
8 - 5/16	RS 80 ACGB 39	54.30	E90 RS 80 ACGB 39	E135 RS 80 ACGB 39	I90 RS 80 ACGB 39	I135 RS 80 ACGB 39	22.35
10 - 3/8	RS 100 ACGB 39	54.88	E90 RS 100 ACGB 39	E135 RS 100 ACGB 39	I90 RS 100 ACGB 39	I135 RS 100 ACGB 39	22.35
12.5 - 1/2	RS 125 ACGB 39	56.26	E90 RS 125 ACGB 39	E135 RS 125 ACGB 39	I90 RS 125 ACGB 39	I135 RS 125 ACGB 39	22.35
A: 57 mm - 2-1/4"							
8 - 5/16	RS 80 ACGB 57	54.84	E90 RS 80 ACGB 57	E135 RS 80 ACGB 57	I90 RS 80 ACGB 57	I135 RS 80 ACGB 57	22.35
10 - 3/8	RS 100 ACGB 57	55.44	E90 RS 100 ACGB 57	E135 RS 100 ACGB 57	I90 RS 100 ACGB 57	I135 RS 100 ACGB 57	22.35
12.5 - 1/2	RS 125 ACGB 57	56.84	E90 RS 125 ACGB 57	E135 RS 125 ACGB 57	I90 RS 125 ACGB 57	I135 RS 125 ACGB 57	22.35

Length = 2.5 m - 8' 2-1/2"	Satin nickel anod. alu. (AT)						
H = mm - in.	Profile	\$ / Length	Outside corner, 90°	Outside corner, 135°	Inside corner, 90°	Inside corner, 135°	\$ / Unit
A: 39 mm - 1-1/2"							
8 - 5/16	RS 80 AT 39	41.91	E90 RS 80 AT 39	E135 RS 80 AT 39	I90 RS 80 AT 39	I135 RS 80 AT 39	20.72
10 - 3/8	RS 100 AT 39	42.60	E90 RS 100 AT 39	E135 RS 100 AT 39	I90 RS 100 AT 39	I135 RS 100 AT 39	20.72
12.5 - 1/2	RS 125 AT 39	44.53	E90 RS 125 AT 39	E135 RS 125 AT 39	I90 RS 125 AT 39	I135 RS 125 AT 39	20.72
A: 57 mm - 2-1/4"							
8 - 5/16	RS 80 AT 57	42.77	E90 RS 80 AT 57	E135 RS 80 AT 57	I90 RS 80 AT 57	I135 RS 80 AT 57	20.72
10 - 3/8	RS 100 AT 57	43.47	E90 RS 100 AT 57	E135 RS 100 AT 57	I90 RS 100 AT 57	I135 RS 100 AT 57	20.72
12.5 - 1/2	RS 125 AT 57	45.43	E90 RS 125 AT 57	E135 RS 125 AT 57	I90 RS 125 AT 57	I135 RS 125 AT 57	20.72



Schluter®-RONDEC-STEP							
Length = 2.5 m - 8' 2-1/2"	Brushed nickel anod. alu. (ATGB)						
H = mm - in.	Profile	\$ / Length	Outside corner, 90°	Outside corner, 135°	Inside corner, 90°	Inside corner, 135°	\$ / Unit
A: 39 mm - 1-1/2"							
8 - 5/16	RS 80 ATGB 39	54.30	E90 RS 80 ATGB 39	E135 RS 80 ATGB 39	I90 RS 80 ATGB 39	I135 RS 80 ATGB 39	22.35
10 - 3/8	RS 100 ATGB 39	54.88	E90 RS 100 ATGB 39	E135 RS 100 ATGB 39	I90 RS 100 ATGB 39	I135 RS 100 ATGB 39	22.35
12.5 - 1/2	RS 125 ATGB 39	56.26	E90 RS 125 ATGB 39	E135 RS 125 ATGB 39	I90 RS 125 ATGB 39	I135 RS 125 ATGB 39	22.35

Length = 2.5 m - 8' 2-1/2"	Satin copper anod. alu. (AK)						
H = mm - in.	Profile	\$ / Length	Outside corner, 90°	Outside corner, 135°	Inside corner, 90°	Inside corner, 135°	\$ / Unit
A: 39 mm - 1-1/2"							
8 - 5/16	RS 80 AK 39	41.91	E90 RS 80 AK 39	E135 RS 80 AK 39	I90 RS 80 AK 39	I135 RS 80 AK 39	20.72
10 - 3/8	RS 100 AK 39	42.60	E90 RS 100 AK 39	E135 RS 100 AK 39	I90 RS 100 AK 39	I135 RS 100 AK 39	20.72
12.5 - 1/2	RS 125 AK 39	44.53	E90 RS 125 AK 39	E135 RS 125 AK 39	I90 RS 125 AK 39	I135 RS 125 AK 39	20.72
A: 57 mm - 2-1/4"							
8 - 5/16	RS 80 AK 57	42.77	E90 RS 80 AK 57	E135 RS 80 AK 57	I90 RS 80 AK 57	I135 RS 80 AK 57	20.72
10 - 3/8	RS 100 AK 57	43.47	E90 RS 100 AK 57	E135 RS 100 AK 57	I90 RS 100 AK 57	I135 RS 100 AK 57	20.72
12.5 - 1/2	RS 125 AK 57	45.43	E90 RS 125 AK 57	E135 RS 125 AK 57	I90 RS 125 AK 57	I135 RS 125 AK 57	20.72

Length = 2.5 m - 8' 2-1/2"	Brushed copper anod. alu. (AKGB)						
H = mm - in.	Profile	\$ / Length	Outside corner, 90°	Outside corner, 135°	Inside corner, 90°	Inside corner, 135°	\$ / Unit
A: 39 mm - 1-1/2"							
8 - 5/16	RS 80 AKGB 39	54.30	E90 RS 80 AKGB 39	E135 RS 80 AKGB 39	I90 RS 80 AKGB 39	I135 RS 80 AKGB 39	22.35
10 - 3/8	RS 100 AKGB 39	54.88	E90 RS 100 AKGB 39	E135 RS 100 AKGB 39	I90 RS 100 AKGB 39	I135 RS 100 AKGB 39	22.35
12.5 - 1/2	RS 125 AKGB 39	56.26	E90 RS 125 AKGB 39	E135 RS 125 AKGB 39	I90 RS 125 AKGB 39	I135 RS 125 AKGB 39	22.35
A: 57 mm - 2-1/4"							
8 - 5/16	RS 80 AKGB 57	54.84	E90 RS 80 AKGB 57	E135 RS 80 AKGB 57	I90 RS 80 AKGB 57	I135 RS 80 AKGB 57	22.35
10 - 3/8	RS 100 AKGB 57	55.44	E90 RS 100 AKGB 57	E135 RS 100 AKGB 57	I90 RS 100 AKGB 57	I135 RS 100 AKGB 57	22.35
12.5 - 1/2	RS 125 AKGB 57	56.84	E90 RS 125 AKGB 57	E135 RS 125 AKGB 57	I90 RS 125 AKGB 57	I135 RS 125 AKGB 57	22.35

Length = 2.5 m - 8' 2-1/2"	Satin brass anod. alu. (AM)						
H = mm - in.	Profile	\$ / Length	Outside corner, 90°	Outside corner, 135°	Inside corner, 90°	Inside corner, 135°	\$ / Unit
A: 57 mm - 2-1/4"							
8 - 5/16	RS 80 AM 57	42.77	E90 RS 80 AM 57	E135 RS 80 AM 57	I90 RS 80 AM 57	I135 RS 80 AM 57	20.72
10 - 3/8	RS 100 AM 57	43.47	E90 RS 100 AM 57	E135 RS 100 AM 57	I90 RS 100 AM 57	I135 RS 100 AM 57	20.72
12.5 - 1/2	RS 125 AM 57	45.43	E90 RS 125 AM 57	E135 RS 125 AM 57	I90 RS 125 AM 57	I135 RS 125 AM 57	20.72

Length = 2.5 m - 8' 2-1/2"	Brushed brass anod. alu. (AMGB)						
H = mm - in.	Profile	\$ / Length	Outside corner, 90°	Outside corner, 135°	Inside corner, 90°	Inside corner, 135°	\$ / Unit
A: 39 mm - 1-1/2"							
8 - 5/16	RS 80 AMGB 39	54.30	E90 RS 80 AMGB 39	E135 RS 80 AMGB 39	I90 RS 80 AMGB 39	I135 RS 80 AMGB 39	22.35
10 - 3/8	RS 100 AMGB 39	54.88	E90 RS 100 AMGB 39	E135 RS 100 AMGB 39	I90 RS 100 AMGB 39	I135 RS 100 AMGB 39	22.35
12.5 - 1/2	RS 125 AMGB 39	56.26	E90 RS 125 AMGB 39	E135 RS 125 AMGB 39	I90 RS 125 AMGB 39	I135 RS 125 AMGB 39	22.35
A: 57 mm - 2-1/4"							
8 - 5/16	RS 80 AMGB 57	54.84	E90 RS 80 AMGB 57	E135 RS 80 AMGB 57	I90 RS 80 AMGB 57	I135 RS 80 AMGB 57	22.35
10 - 3/8	RS 100 AMGB 57	55.44	E90 RS 100 AMGB 57	E135 RS 100 AMGB 57	I90 RS 100 AMGB 57	I135 RS 100 AMGB 57	22.35
12.5 - 1/2	RS 125 AMGB 57	56.84	E90 RS 125 AMGB 57	E135 RS 125 AMGB 57	I90 RS 125 AMGB 57	I135 RS 125 AMGB 57	22.35



Schluter®-RONDEC-STEP							
Length = 2.5 m - 8' 2-1/2"	Brushed antique bronze anod. alu. (ABGB)						
H = mm - in.	Profile	\$ / Length	Outside corner, 90°	Outside corner, 135°	Inside corner, 90°	Inside corner, 135°	\$ / Unit
A: 39 mm - 1-1/2"							
8 - 5/16	RS 80 ABGB 39	54.30	E90 RS 80 ABGB 39	E135 RS 80 ABGB 39	I90 RS 80 ABGB 39	I135 RS 80 ABGB 39	22.35
10 - 3/8	RS 100 ABGB 39	54.88	E90 RS 100 ABGB 39	E135 RS 100 ABGB 39	I90 RS 100 ABGB 39	I135 RS 100 ABGB 39	22.35
12.5 - 1/2	RS 125 ABGB 39	56.26	E90 RS 125 ABGB 39	E135 RS 125 ABGB 39	I90 RS 125 ABGB 39	I135 RS 125 ABGB 39	22.35

Schluter®-RONDEC-CT

Schluter®-RONDEC-CT is a double-rail edging profile for countertops to be fitted with a ceramic or dimension stone tile covering. The face of the profile features a recessed section to which field or accent tile is bonded. The top and bottom edges of the profile are symmetrically rounded and match the Schluter®-RONDEC profile (page 27). RONDEC-CT features an integrated joint spacer that establishes a defined joint cavity between the tile and the profile.

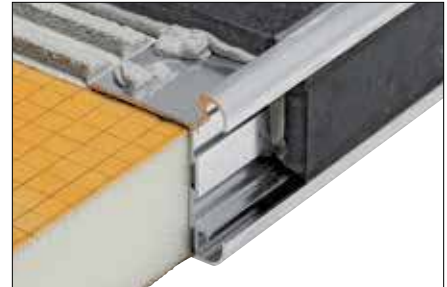
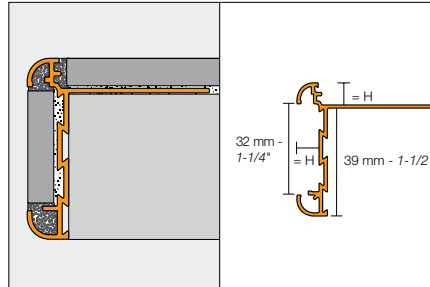

Outside corner (90° or 135°)



Inside corner (90° or 135°)



Schluter®-RONDEC-CT							
Length = 2.5 m - 8' 2-1/2"	Satin anodized aluminum (AE)						
H = mm - in.	Profile	\$ / Length	Outside corner, 90°	Outside corner, 135°	Inside corner, 90°	Inside corner, 135°	\$ / Unit
8 - 5/16	RC 80 AE 39	44.64	E90 RC 80 AE 39	E135 RC 80 AE 39	I90 RC 80 AE 39	I135 RC 80 AE 39	23.40
10 - 3/8	RC 100 AE 39	45.42	E90 RC 100 AE 39	E135 RC 100 AE 39	I90 RC 100 AE 39	I135 RC 100 AE 39	23.40
12.5 - 1/2	RC 125 AE 39	47.47	E90 RC 125 AE 39	E135 RC 125 AE 39	I90 RC 125 AE 39	I135 RC 125 AE 39	23.40

Schluter®-RONDEC-CT							
Length = 2.5 m - 8' 2-1/2"	Brushed chrome anod. alu. (ACGB)						
H = mm - in.	Profile	\$ / Length	Outside corner, 90°	Outside corner, 135°	Inside corner, 90°	Inside corner, 135°	\$ / Unit
8 - 5/16	RC 80 ACGB 39	50.70	E90 RC 80 ACGB 39	E135 RC 80 ACGB 39	I90 RC 80 ACGB 39	I135 RC 80 ACGB 39	26.97
10 - 3/8	RC 100 ACGB 39	51.00	E90 RC 100 ACGB 39	E135 RC 100 ACGB 39	I90 RC 100 ACGB 39	I135 RC 100 ACGB 39	26.97
12.5 - 1/2	RC 125 ACGB 39	52.77	E90 RC 125 ACGB 39	E135 RC 125 ACGB 39	I90 RC 125 ACGB 39	I135 RC 125 ACGB 39	26.97

Schluter®-RONDEC-CT							
Length = 2.5 m - 8' 2-1/2"	Satin nickel anod. alu. (AT)						
H = mm - in.	Profile	\$ / Length	Outside corner, 90°	Outside corner, 135°	Inside corner, 90°	Inside corner, 135°	\$ / Unit
8 - 5/16	RC 80 AT 39	48.88	E90 RC 80 AT 39	E135 RC 80 AT 39	I90 RC 80 AT 39	I135 RC 80 AT 39	23.40
10 - 3/8	RC 100 AT 39	49.98	E90 RC 100 AT 39	E135 RC 100 AT 39	I90 RC 100 AT 39	I135 RC 100 AT 39	23.40
12.5 - 1/2	RC 125 AT 39	52.07	E90 RC 125 AT 39	E135 RC 125 AT 39	I90 RC 125 AT 39	I135 RC 125 AT 39	23.40



Schluter®-RONDEC-CT							
Length = 2.5 m - 8' 2-1/2"	Brushed nickel anod. alu. (ATGB)						
H = mm - in.	Profile	\$/ Length	Outside corner, 90°	Outside corner, 135°	Inside corner, 90°	Inside corner, 135°	\$/ Unit
8 - 5/16	RC 80 ATGB 39	53.14	E90 RC 80 ATGB 39	E135 RC 80 ATGB 39	I90 RC 80 ATGB 39	I135 RC 80 ATGB 39	26.97
10 - 3/8	RC 100 ATGB 39	54.13	E90 RC 100 ATGB 39	E135 RC 100 ATGB 39	I90 RC 100 ATGB 39	I135 RC 100 ATGB 39	26.97
12.5 - 1/2	RC 125 ATGB 39	54.55	E90 RC 125 ATGB 39	E135 RC 125 ATGB 39	I90 RC 125 ATGB 39	I135 RC 125 ATGB 39	26.97

Length = 2.5 m - 8' 2-1/2"	Satin copper anod. alu. (AK)						
H = mm - in.	Profile	\$/ Length	Outside corner, 90°	Outside corner, 135°	Inside corner, 90°	Inside corner, 135°	\$/ Unit
8 - 5/16	RC 80 AK 39	48.88	E90 RC 80 AK 39	E135 RC 80 AK 39	I90 RC 80 AK 39	I135 RC 80 AK 39	23.40
10 - 3/8	RC 100 AK 39	49.98	E90 RC 100 AK 39	E135 RC 100 AK 39	I90 RC 100 AK 39	I135 RC 100 AK 39	23.40
12.5 - 1/2	RC 125 AK 39	52.07	E90 RC 125 AK 39	E135 RC 125 AK 39	I90 RC 125 AK 39	I135 RC 125 AK 39	23.40

Length = 2.5 m - 8' 2-1/2"	Brushed copper anod. alu. (AKGB)						
H = mm - in.	Profile	\$/ Length	Outside corner, 90°	Outside corner, 135°	Inside corner, 90°	Inside corner, 135°	\$/ Unit
8 - 5/16	RC 80 AKGB 39	53.14	E90 RC 80 AKGB 39	E135 RC 80 AKGB 39	I90 RC 80 AKGB 39	I135 RC 80 AKGB 39	26.97
10 - 3/8	RC 100 AKGB 39	54.13	E90 RC 100 AKGB 39	E135 RC 100 AKGB 39	I90 RC 100 AKGB 39	I135 RC 100 AKGB 39	26.97
12.5 - 1/2	RC 125 AKGB 39	54.55	E90 RC 125 AKGB 39	E135 RC 125 AKGB 39	I90 RC 125 AKGB 39	I135 RC 125 AKGB 39	26.97

Length = 2.5 m - 8' 2-1/2"	Satin brass anod. alu. (AM)						
H = mm - in.	Profile	\$/ Length	Outside corner, 90°	Outside corner, 135°	Inside corner, 90°	Inside corner, 135°	\$/ Unit
8 - 5/16	RC 80 AM 39	46.05	E90 RC 80 AM 39	E135 RC 80 AM 39	I90 RC 80 AM 39	I135 RC 80 AM 39	23.40
10 - 3/8	RC 100 AM 39	47.16	E90 RC 100 AM 39	E135 RC 100 AM 39	I90 RC 100 AM 39	I135 RC 100 AM 39	23.40
12.5 - 1/2	RC 125 AM 39	49.23	E90 RC 125 AM 39	E135 RC 125 AM 39	I90 RC 125 AM 39	I135 RC 125 AM 39	23.40

Length = 2.5 m - 8' 2-1/2"	Brushed brass anod. alu. (AMGB)						
H = mm - in.	Profile	\$/ Length	Outside corner, 90°	Outside corner, 135°	Inside corner, 90°	Inside corner, 135°	\$/ Unit
8 - 5/16	RC 80 AMGB 39	50.70	E90 RC 80 AMGB 39	E135 RC 80 AMGB 39	I90 RC 80 AMGB 39	I135 RC 80 AMGB 39	26.97
10 - 3/8	RC 100 AMGB 39	51.00	E90 RC 100 AMGB 39	E135 RC 100 AMGB 39	I90 RC 100 AMGB 39	I135 RC 100 AMGB 39	26.97
12.5 - 1/2	RC 125 AMGB 39	52.77	E90 RC 125 AMGB 39	E135 RC 125 AMGB 39	I90 RC 125 AMGB 39	I135 RC 125 AMGB 39	26.97

Schluter®-TRENDLINE Textured Color-coated Aluminum

Length = 2.5 m - 8' 2-1/2"	Textured color-coated aluminum (TS)		
H = mm - in.	Profile	\$/ Length	
8 - 5/16	RC 80 + color* 39	70.51	
10 - 3/8	RC 100 + color* 39	74.33	
12.5 - 1/2	RC 125 + color* 39	76.15	

***Color Codes**

 TSB Beige	 TSOB Bronze	 TSG Pewter
---	---	---

* To complete the item number, add the **color** code (e.g., RC 80 **TSB** 39).

Length = 2.5 m - 8' 2-1/2"	Textured color-coated aluminum (TS)				
H = mm - in.	Outside corner, 90°	Outside corner, 135°	Inside corner, 90°	Inside corner, 135°	\$/ Unit
8 - 5/16	E90 RC 80 + color* 39	E135 RC 80 + color* 39	I90 RC 80 + color* 39	I135 RC 80 + color* 39	30.09
10 - 3/8	E90 RC 100 + color* 39	E135 RC 100 + color* 39	I90 RC 100 + color* 39	I135 RC 100 + color* 39	30.09
12.5 - 1/2	E90 RC 125 + color* 39	E135 RC 125 + color* 39	I90 RC 125 + color* 39	I135 RC 125 + color* 39	30.09



Schluter®-SCHIENE-STEP

Schluter®-SCHIENE-STEP is a finishing and edging profile for ceramic tile and natural stone installations on countertops, stairs, and tile over tile applications on walls. The top of the profile features a vertical wall section that finishes and protects the tile from damage, while the vertical leg covers the edge of the sub-assembly, top of the riser, or existing wall tile edge.

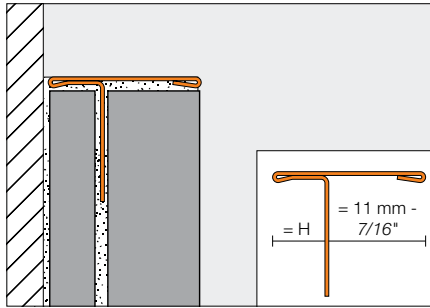
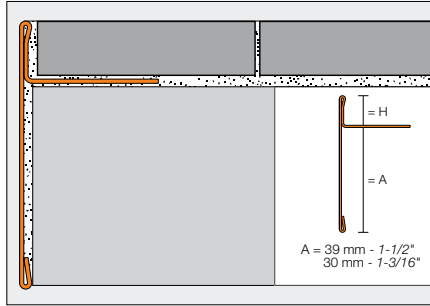

Schluter®-SCHIENE-STEP							
Length = 2.5 m - 8' 2-1/2"	Brushed Stainless Steel 304 (1.4301 = V2A) (EB)						
H = mm - in.	Profile	\$ / Length	Inside corner, 90°	Inside corner, 135°	Outside corner, 90° and End Cap	Outside corner, 135°	\$ / Unit
A: 39 mm - 1-1/2"							
6 - 1/4	SS 60 EB 39	130.74	I90 / SS 60 EB 39	I135 / SS 60 EB 39	E90 / SS 60 EB 39	E135 / SS 60 EB 39	17.54
9 - 11/32	SS 90 EB 39	136.16	I90 / SS 90 EB 39	I135 / SS 90 EB 39	E90 / SS 90 EB 39	E135 / SS 90 EB 39	17.54
11 - 7/16	SS 110 EB 39	137.78	I90 / SS 110 EB 39	I135 / SS 110 EB 39	E90 / SS 110 EB 39	E135 / SS 110 EB 39	17.54
12.5 - 1/2	SS 125 EB 39	140.79	I90 / SS 125 EB 39	I135 / SS 125 EB 39	E90 / SS 125 EB 39	E135 / SS 125 EB 39	17.54
A: 30 mm - 1-3/16"							
9 - 11/32	SS 90 EB 30	101.86	-	-	E90 / SS 90 EB 30	-	17.54
11 - 7/16	SS 110 EB 30	103.11	-	-	E90 / SS 110 EB 30	-	17.54
12.5 - 1/2	SS 125 EB 30	104.35	-	-	E90 / SS 125 EB 30	-	17.54
A: 11 mm - 7/16"							
6 - 1/4	SS 60 EB 11	99.96					
12.5 - 1/2	SS 125 EB 11	101.16					

Brushed Stainless Steel 304 (1.4301 = V2A) (EB)		
H = mm - in.	Connector	\$ / Unit
A: 39 mm - 1-1/2"		
6 - 1/4	V / SS 60 EB 39	14.90
9 - 11/32	V / SS 90 EB 39	14.90
11 - 7/16	V / SS 110 EB 39	14.90
12.5 - 1/2	V / SS 125 EB 39	14.90
A: 30 mm - 1-3/16"		
9 - 11/32	V / SS 90 EB 30	14.90
11 - 7/16	V / SS 110 EB 30	14.90
12.5 - 1/2	V / SS 125 EB 30	14.90
A: 11 mm - 7/16"		
6 - 1/4	V / SS 60 EB 11	14.90
12.5 - 1/2	V / SS 125 EB 11	14.90

Note: The anchoring leg of **Schluter®-SCHIENE-STEP** is available with a special radius perforation so that the profile can be used to form curves.

- Price surcharge: \$0.60 per foot
- Item No.: R / Profile No. (e.g., R/SS 60 EB 11)
- For delivery time, please call Customer Service





Schluter®-ECK-E

Schluter®-ECK-E is a stainless steel edging profile for outside corners of tiled walls that offers excellent edge protection against mechanical stresses in commercial/industrial applications. The profile produces a radiused edge along the outside wall corner for a clean, decorative finish. ECK-E is installed simultaneously with the tile, while ECK-K (page 50) is subsequently installed on the outside corners of existing installations.

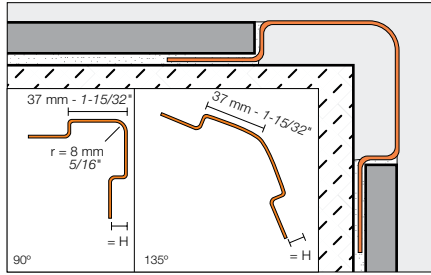

Note: ECK-E is also available in stainless steel 316L (1.4404 = V4A). Contact Customer Service for price and availability.

Schluter®-ECK-E				
H = mm - in.	Stainless steel 304 (1.4301 = V2A) (E)		Brushed stainless steel 304 (1.4301 = V2A) (EB)	
	Item No.	\$ / Length	Item No.	\$ / Length
90° Angle				
L = 1.50 m - 4' 11"				
6 - 1/4	E37 V2A 60/150	63.00	E37 V2A EB 60/150	81.90
8 - 5/16	E37 V2A 80/150	65.52	E37 V2A EB 80/150	85.19
11 - 7/16	E37 V2A 110/150	68.11	E37 V2A EB 110/150	88.56
L = 2.00 m - 6' 7"				
6 - 1/4	E37 V2A 60/200	80.92	E37 V2A EB 60/200	105.20
8 - 5/16	E37 V2A 80/200	84.17	E37 V2A EB 80/200	109.42
11 - 7/16	E37 V2A 110/200	87.64	E37 V2A EB 110/200	113.96
L = 2.5 m - 8' 2-1/2"				
6 - 1/4	E37 V2A 60/250	98.88	E37 V2A EB 60/250	129.66
8 - 5/16	E37 V2A 80/250	102.84	E37 V2A EB 80/250	133.70
11 - 7/16	E37 V2A 110/250	107.18	E37 V2A EB 110/250	139.35
L = 3.00 m - 9' 10"				
6 - 1/4	E37 V2A 60/300	122.41	E37 V2A EB 60/300	159.13
8 - 5/16	E37 V2A 80/300	129.21	E37 V2A EB 80/300	167.98
11 - 7/16	E37 V2A 110/300	133.74	E37 V2A EB 110/300	173.86
135° Angle				
L = 2.5 m - 8' 2-1/2"				
6 - 1/4	E37 E 60S	91.89	E37 EB 60S	119.66
8 - 5/16	E37 E 80S	95.24	E37 EB 80S	123.93
11 - 7/16	E37 E 110S	99.10	E37 EB 110S	128.85
L = 3.00 m - 9' 10"				
6 - 1/4	E37 E 60S/300	110.19	E37 EB 60S/300	143.51
8 - 5/16	E37 E 80S/300	114.23	E37 EB 80S/300	148.71
11 - 7/16	E37 E 110S/300	118.91	E37 EB 110S/300	154.60



Schluter®-ECK-K

Schluter®-ECK-K is a stainless steel edging profile for outside corners of tiled walls that offers excellent edge protection against mechanical stresses in commercial/ industrial applications. The profile produces a radiused edge along the outside wall corner for a clean, decorative finish. ECK-K is subsequently bonded to the outside corners of existing installations. As such, ECK-K can be installed as a repair so that existing, damaged corners do not have to be replaced.

Note: ECK-K is also available in stainless steel 316L (1.4404 = V4A). Contact Customer Service for price and availability.

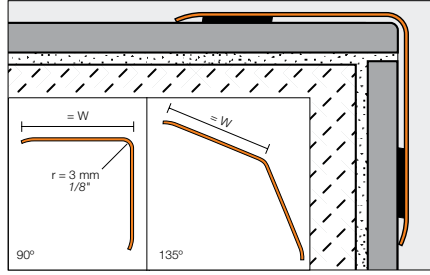

Schluter®-ECK-K

W = mm - in.	Stainless steel 304 (1.4301 = V2A) (E)		Brushed stainless steel 304 (1.4301 = V2A) (EB)	
	Item No.	\$ / Length	Item No.	\$ / Length
90° Angle				
L = 1.50 m - 4' 11"				
15 - 9/16	K15 V2A/150	35.03	K15 V2A EB/150	45.55
32 - 1-9/32	K32 V2A/150	61.29	K32 V2A EB/150	79.68
50 - 2	K50 V2A/150	78.87	K50 V2A EB/150	102.52
L = 2.00 m - 6' 7"				
32 - 1-9/32	K32 V2A/200	81.78	K32 V2A EB/200	106.33
50 - 2	K50 V2A/200	105.09	K50 V2A EB/200	136.58
L = 2.5 m - 8' 2-1/2"				
15 - 9/16	K15 V2A/250	58.34	K15 V2A EB/250	75.92
32 - 1-9/32	K32 V2A/250	102.18	K32 V2A EB/250	132.84
50 - 2	K50 V2A/250	131.37	K50 V2A EB/250	169.45
L = 3.00 m - 9' 10"				
15 - 9/16	K15 V2A/300	69.99	K15 V2A EB/300	90.97
32 - 1-9/32	K32 V2A/300	121.28	K32 V2A EB/300	157.66
50 - 2	K50 V2A/300	156.41	K50 V2A EB/300	203.33
135° Angle				
L = 1.50 m - 4' 11"				
32 - 1-9/32	K32 ES/150	55.94		
L = 2.5 m - 8' 2-1/2"				
32 - 1-9/32	K32 ES	93.18		
L = 3.00 m - 9' 10"				
32 - 1-9/32	K32 ES/300	111.83		



Schluter®-ECK-KHK

Schluter®-ECK-KHK is a stainless steel profile for inside wall corners that produces a radiused edge for a clean, decorative finish. ECK-KHK provides a 5/16" (8 mm) radius to prevent the accumulation of dirt and make cleaning simple. Thus, the profile is especially suited for commercial kitchens, bathrooms, food processing plants or any environment where a sanitary corner is desired. ECK-KHK is subsequently bonded to the inside corners of existing tile or other wall coverings. As such, the profile can be installed as a repair so that existing, damaged corners do not have to be replaced.

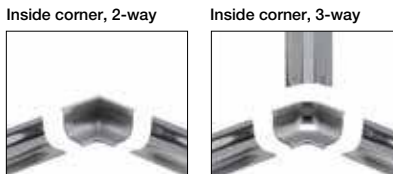
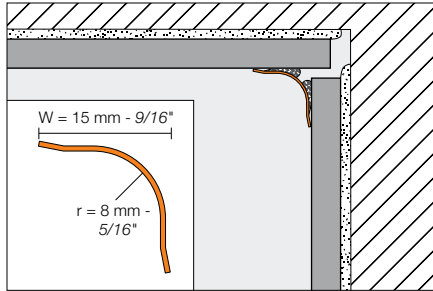

Schluter®-ECK-KHK

Stainless steel 304 (1.4301 = V2A) (E)						
W = mm - in.	Profile	\$ / Length	Outside corner, 90°	Inside corner, 90° (2-way)	Inside corner, 90° (3-way)	\$ / Unit
L = 1.50 m - 4' 11"			E/KHK 15 E	I/2KHK 15 E	I/3KHK 15 E	8.94
15 - 9/16	KHK 15 E/150	22.08				
L = 2.00 m - 6' 7"						
15 - 9/16	KHK 15 E/200	29.44				
L = 2.5 m - 8' 2-1/2"						
15 - 9/16	KHK 15 E	36.80				
L = 3.00 m - 9' 10"						
15 - 9/16	KHK 15 E/300	44.16				
Connector	V/KHK 15 E					6.06

Brushed stainless steel 304 (1.4301 = V2A) (EB)						
W = mm - in.	Profile	\$ / Length	Outside corner, 90°	Inside corner, 90° (2-way)	Inside corner, 90° (3-way)	\$ / Unit
L = 1.50 m - 4' 11"			E/KHK 15 EB	I/2KHK 15 EB	I/3KHK 15 EB	8.94
15 - 9/16	KHK 15 EB/150	24.79				
L = 2.00 m - 6' 7"						
15 - 9/16	KHK 15 EB/200	33.06				
L = 2.5 m - 8' 2-1/2"						
15 - 9/16	KHK 15 EB	41.33				
L = 3.00 m - 9' 10"						
15 - 9/16	KHK 15 EB/300	49.59				
Connector	V/KHK 15 EB					6.06



Schluter®-ECK-KI

Schluter®-ECK-KI is a stainless steel profile for inside wall corners that produces a clean, decorative finish. ECK-KI is subsequently bonded to the inside corners of existing tile or other wall coverings. As such, the profile can be installed as a repair so that existing, damaged corners do not have to be replaced.

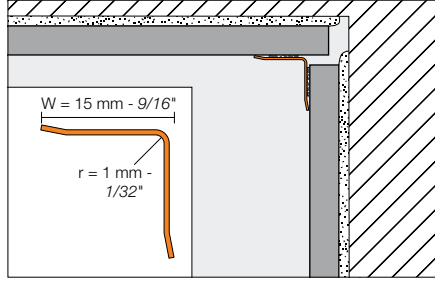

Schluter®-ECK-KI				
W = mm - in.	Stainless steel 304 (1.4301 = V2A) (E)		Brushed stainless steel 304 (1.4301 = V2A) (EB)	
	Item No.	\$ / Length	Item No.	\$ / Length
L = 1.50 m - 4' 11"				
15 - 9/16	KI15 E/150	22.08	KI15 EB/150	24.79
L = 2.00 m - 6' 7"				
15 - 9/16	KI15 E/200	29.44	KI15 EB/200	33.06
L = 2.5 m - 8' 2-1/2"				
15 - 9/16	KI15 E	36.80	KI15 EB	41.33
L = 3.00 m - 9' 10"				
15 - 9/16	KI15 E/300	44.16	KI15 EB/300	49.59

Schluter®-REMA

Schluter®-REMA is a system for creating concealed access panels in tiled walls without impairing the visual appearance of the tile covering. REMA is suited for all tile sizes and thicknesses, and adapts perfectly to the joint pattern.

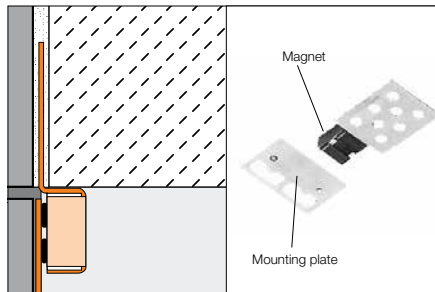

Schluter®-REMA	
Set = 4 Magnets + 4 Mounting plates	
Item No.	\$ / Set
REMA	11.66



Schluter®-DESIGNBASE-SL

The **Schluter®-DESIGNBASE-SL** profile is an alternative to baseboard, which is available in anodized and color-coated aluminum. DESIGNBASE features a clean, polished look, and is simply attached to the wall with a suitable adhesive. An optional sealing lip accessory is available to protect the floor/wall transition from moisture penetration and to reduce the transmission of impact sound.

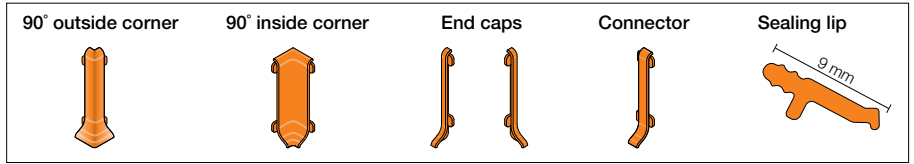
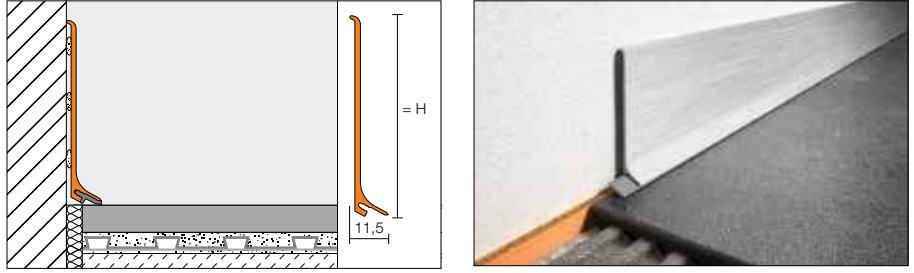

Schluter®-DESIGNBASE						
Length = 2.5 m - 8' 2-1/2"	Satin anodized aluminum (AE)					
H = mm - in.	Profile	\$/ Length	90° outside corner	\$/ Unit	90° inside corner	\$/ Unit
60 - 2-3/8	DB SL 60 AE	30.08	ED / DB SL 60 AE	11.00	ID / DB SL 60 AE	11.00
80 - 3-1/8	DB SL 80 AE	36.76	ED / DB SL 80 AE	11.00	ID / DB SL 80 AE	11.00

H = mm - in.	End cap (left)	\$/ Unit	End cap (right)	\$/ Unit	Connector	\$/ Unit
60 - 2-3/8	EL / DB SL 60 AE	9.67	ER / DB SL 60 AE	9.67	V / DB SL 60 AE	9.67
80 - 3-1/8	EL / DB SL 80 AE	9.67	ER / DB SL 80 AE	9.67	V / DB SL 80 AE	9.67

Length = 2.5 m - 8' 2-1/2"	Anodized aluminum with brushed stainless steel appearance (AEEB)					
H = mm - in.	Profile	\$/ Length	90° outside corner	\$/ Unit	90° inside corner	\$/ Unit
60 - 2-3/8	DB SL 60 AEEB	93.01	ED / DB SL 60 AEEB	11.00	ID / DB SL 60 AEEB	11.00
80 - 3-1/8	DB SL 80 AEEB	122.02	ED / DB SL 80 AEEB	11.00	ID / DB SL 80 AEEB	11.00

H = mm - in.	End cap (left)	\$/ Unit	End cap (right)	\$/ Unit	Connector	\$/ Unit
60 - 2-3/8	EL / DB SL 60 AEEB	9.67	ER / DB SL 60 AEEB	9.67	V / DB SL 60 AEEB	9.67
80 - 3-1/8	EL / DB SL 80 AEEB	9.67	ER / DB SL 80 AEEB	9.67	V / DB SL 80 AEEB	9.67

Note: For reasons associated with production technology, inside corners ID / DB SL 60 AEEB and ID / DB SL 80 AEEB are not brushed.

Length = 2.5 m - 8' 2-1/2"	Matte white color-coated aluminum (MBW)					
H = mm - in.	Profile	\$/ Length	90° outside corner	\$/ Unit	90° inside corner	\$/ Unit
60 - 2-3/8	DB SL 60 MBW	51.67	ED / DB SL 60 MBW	11.00	ID / DB SL 60 MBW	11.00
80 - 3-1/8	DB SL 80 MBW	73.34	ED / DB SL 80 MBW	11.00	ID / DB SL 80 MBW	11.00

H = mm - in.	End cap (left)	\$/ Unit	End cap (right)	\$/ Unit	Connector	\$/ Unit
60 - 2-3/8	EL / DB SL 60 MBW	9.67	ER / DB SL 60 MBW	9.67	V / DB SL 60 MBW	9.67
80 - 3-1/8	EL / DB SL 80 MBW	9.67	ER / DB SL 80 MBW	9.67	V / DB SL 80 MBW	9.67

Length = 2.5 m - 8' 2-1/2"	Schluter®-DESIGNBASE-SLZ	
	Sealing lip	\$/ Unit
	DB ZS LL	11.00



Schluter®-Profiles

STAIR-NOSING PROFILES

Tiled stairs edges that do not utilize appropriate trim pieces are vulnerable to chipping and breaking and create a slip hazard, especially in exterior applications. Schluter® stair-nosing profiles protect exposed tile edges and improve safety on tiled stairways by providing slip-resistant wear surfaces and increased visibility in both residential and commercial applications.





Schluter®-RONDEC-STEP

Schluter®-RONDEC-STEP is a finishing and edging profile for ceramic tile and dimension stone installations on countertops and stairs. The top of the profile features a symmetrically rounded edge that matches the Schluter®-RONDEC profile (page 27), while the vertical leg of the profile hides the exposed edge of the sub-assembly. RONDEC-STEP features an integrated joint spacer that establishes a defined joint cavity between the tile and the profile.

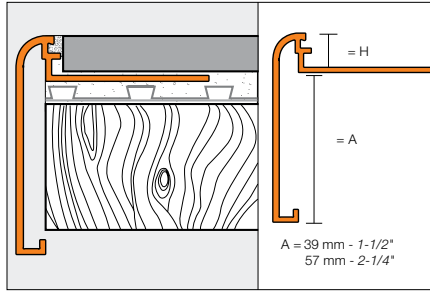

Outside corner (90° or 135°)

Inside corner (90° or 135°)



Schluter®-RONDEC-STEP

Length = 2.5 m - 8' 2-1/2"		Satin anodized aluminum (AE)						
H = mm - in.	Profile	\$/ Length	Outside corner, 90°	Outside corner, 135°	Inside corner, 90°	Inside corner, 135°	\$/ Unit	
A: 39 mm - 1-1/2"								
8 - 5/16	RS 80 AE 39	41.91	E90 RS 80 AE 39	E135 RS 80 AE 39	I90 RS 80 AE 39	I135 RS 80 AE 39	20.72	
10 - 3/8	RS 100 AE 39	42.60	E90 RS 100 AE 39	E135 RS 100 AE 39	I90 RS 100 AE 39	I135 RS 100 AE 39	20.72	
12.5 - 1/2	RS 125 AE 39	44.53	E90 RS 125 AE 39	E135 RS 125 AE 39	I90 RS 125 AE 39	I135 RS 125 AE 39	20.72	
A: 57 mm - 2-1/4"								
8 - 5/16	RS 80 AE 57	42.77	E90 RS 80 AE 57	E135 RS 80 AE 57	I90 RS 80 AE 57	I135 RS 80 AE 57	20.72	
10 - 3/8	RS 100 AE 57	43.47	E90 RS 100 AE 57	E135 RS 100 AE 57	I90 RS 100 AE 57	I135 RS 100 AE 57	20.72	
12.5 - 1/2	RS 125 AE 57	45.43	E90 RS 125 AE 57	E135 RS 125 AE 57	I90 RS 125 AE 57	I135 RS 125 AE 57	20.72	

Length = 2.5 m - 8' 2-1/2"		Brushed chrome anod. alu. (ACGB)						
H = mm - in.	Profile	\$/ Length	Outside corner, 90°	Outside corner, 135°	Inside corner, 90°	Inside corner, 135°	\$/ Unit	
A: 39 mm - 1-1/2"								
8 - 5/16	RS 80 ACGB 39	54.30	E90 RS 80 ACGB 39	E135 RS 80 ACGB 39	I90 RS 80 ACGB 39	I135 RS 80 ACGB 39	22.35	
10 - 3/8	RS 100 ACGB 39	54.88	E90 RS 100 ACGB 39	E135 RS 100 ACGB 39	I90 RS 100 ACGB 39	I135 RS 100 ACGB 39	22.35	
12.5 - 1/2	RS 125 ACGB 39	56.26	E90 RS 125 ACGB 39	E135 RS 125 ACGB 39	I90 RS 125 ACGB 39	I135 RS 125 ACGB 39	22.35	
A: 57 mm - 2-1/4"								
8 - 5/16	RS 80 ACGB 57	54.84	E90 RS 80 ACGB 57	E135 RS 80 ACGB 57	I90 RS 80 ACGB 57	I135 RS 80 ACGB 57	22.35	
10 - 3/8	RS 100 ACGB 57	55.44	E90 RS 100 ACGB 57	E135 RS 100 ACGB 57	I90 RS 100 ACGB 57	I135 RS 100 ACGB 57	22.35	
12.5 - 1/2	RS 125 ACGB 57	56.84	E90 RS 125 ACGB 57	E135 RS 125 ACGB 57	I90 RS 125 ACGB 57	I135 RS 125 ACGB 57	22.35	

Length = 2.5 m - 8' 2-1/2"		Satin nickel anod. alu. (AT)						
H = mm - in.	Profile	\$/ Length	Outside corner, 90°	Outside corner, 135°	Inside corner, 90°	Inside corner, 135°	\$/ Unit	
A: 39 mm - 1-1/2"								
8 - 5/16	RS 80 AT 39	41.91	E90 RS 80 AT 39	E135 RS 80 AT 39	I90 RS 80 AT 39	I135 RS 80 AT 39	20.72	
10 - 3/8	RS 100 AT 39	42.60	E90 RS 100 AT 39	E135 RS 100 AT 39	I90 RS 100 AT 39	I135 RS 100 AT 39	20.72	
12.5 - 1/2	RS 125 AT 39	44.53	E90 RS 125 AT 39	E135 RS 125 AT 39	I90 RS 125 AT 39	I135 RS 125 AT 39	20.72	
A: 57 mm - 2-1/4"								
8 - 5/16	RS 80 AT 57	42.77	E90 RS 80 AT 57	E135 RS 80 AT 57	I90 RS 80 AT 57	I135 RS 80 AT 57	20.72	
10 - 3/8	RS 100 AT 57	43.47	E90 RS 100 AT 57	E135 RS 100 AT 57	I90 RS 100 AT 57	I135 RS 100 AT 57	20.72	
12.5 - 1/2	RS 125 AT 57	45.43	E90 RS 125 AT 57	E135 RS 125 AT 57	I90 RS 125 AT 57	I135 RS 125 AT 57	20.72	

Length = 2.5 m - 8' 2-1/2"		Brushed nickel anod. alu. (ATGB)						
H = mm - in.	Profile	\$/ Length	Outside corner, 90°	Outside corner, 135°	Inside corner, 90°	Inside corner, 135°	\$/ Unit	
A: 39 mm - 1-1/2"								
8 - 5/16	RS 80 ATGB 39	54.30	E90 RS 80 ATGB 39	E135 RS 80 ATGB 39	I90 RS 80 ATGB 39	I135 RS 80 ATGB 39	22.35	
10 - 3/8	RS 100 ATGB 39	54.88	E90 RS 100 ATGB 39	E135 RS 100 ATGB 39	I90 RS 100 ATGB 39	I135 RS 100 ATGB 39	22.35	
12.5 - 1/2	RS 125 ATGB 39	56.26	E90 RS 125 ATGB 39	E135 RS 125 ATGB 39	I90 RS 125 ATGB 39	I135 RS 125 ATGB 39	22.35	



Schluter®-RONDEC-STEP							
Length = 2.5 m - 8' 2-1/2"	Satin copper anod. alu. (AK)						
H = mm - in.	Profile	\$ / Length	Outside corner, 90°	Outside corner, 135°	Inside corner, 90°	Inside corner, 135°	\$ / Unit
A: 39 mm - 1-1/2"							
8 - 5/16	RS 80 AK 39	41.91	E90 RS 80 AK 39	E135 RS 80 AK 39	I90 RS 80 AK 39	I135 RS 80 AK 39	20.72
10 - 3/8	RS 100 AK 39	42.60	E90 RS 100 AK 39	E135 RS 100 AK 39	I90 RS 100 AK 39	I135 RS 100 AK 39	20.72
12.5 - 1/2	RS 125 AK 39	44.53	E90 RS 125 AK 39	E135 RS 125 AK 39	I90 RS 125 AK 39	I135 RS 125 AK 39	20.72
A: 57 mm - 2-1/4"							
8 - 5/16	RS 80 AK 57	42.77	E90 RS 80 AK 57	E135 RS 80 AK 57	I90 RS 80 AK 57	I135 RS 80 AK 57	20.72
10 - 3/8	RS 100 AK 57	43.47	E90 RS 100 AK 57	E135 RS 100 AK 57	I90 RS 100 AK 57	I135 RS 100 AK 57	20.72
12.5 - 1/2	RS 125 AK 57	45.43	E90 RS 125 AK 57	E135 RS 125 AK 57	I90 RS 125 AK 57	I135 RS 125 AK 57	20.72

Length = 2.5 m - 8' 2-1/2"	Brushed copper anod. alu. (AKGB)						
H = mm - in.	Profile	\$ / Length	Outside corner, 90°	Outside corner, 135°	Inside corner, 90°	Inside corner, 135°	\$ / Unit
A: 39 mm - 1-1/2"							
8 - 5/16	RS 80 AKGB 39	54.30	E90 RS 80 AKGB 39	E135 RS 80 AKGB 39	I90 RS 80 AKGB 39	I135 RS 80 AKGB 39	22.35
10 - 3/8	RS 100 AKGB 39	54.88	E90 RS 100 AKGB 39	E135 RS 100 AKGB 39	I90 RS 100 AKGB 39	I135 RS 100 AKGB 39	22.35
12.5 - 1/2	RS 125 AKGB 39	56.26	E90 RS 125 AKGB 39	E135 RS 125 AKGB 39	I90 RS 125 AKGB 39	I135 RS 125 AKGB 39	22.35
A: 57 mm - 2-1/4"							
8 - 5/16	RS 80 AKGB 57	54.84	E90 RS 80 AKGB 57	E135 RS 80 AKGB 57	I90 RS 80 AKGB 57	I135 RS 80 AKGB 57	22.35
10 - 3/8	RS 100 AKGB 57	55.44	E90 RS 100 AKGB 57	E135 RS 100 AKGB 57	I90 RS 100 AKGB 57	I135 RS 100 AKGB 57	22.35
12.5 - 1/2	RS 125 AKGB 57	56.84	E90 RS 125 AKGB 57	E135 RS 125 AKGB 57	I90 RS 125 AKGB 57	I135 RS 125 AKGB 57	22.35

Length = 2.5 m - 8' 2-1/2"	Satin brass anod. alu. (AM)						
H = mm - in.	Profile	\$ / Length	Outside corner, 90°	Outside corner, 135°	Inside corner, 90°	Inside corner, 135°	\$ / Unit
A: 57 mm - 2-1/4"							
8 - 5/16	RS 80 AM 57	42.77	E90 RS 80 AM 57	E135 RS 80 AM 57	I90 RS 80 AM 57	I135 RS 80 AM 57	20.72
10 - 3/8	RS 100 AM 57	43.47	E90 RS 100 AM 57	E135 RS 100 AM 57	I90 RS 100 AM 57	I135 RS 100 AM 57	20.72
12.5 - 1/2	RS 125 AM 57	45.43	E90 RS 125 AM 57	E135 RS 125 AM 57	I90 RS 125 AM 57	I135 RS 125 AM 57	20.72

Length = 2.5 m - 8' 2-1/2"	Brushed brass anod. alu. (AMGB)						
H = mm - in.	Profile	\$ / Length	Outside corner, 90°	Outside corner, 135°	Inside corner, 90°	Inside corner, 135°	\$ / Unit
A: 39 mm - 1-1/2"							
8 - 5/16	RS 80 AMGB 39	54.30	E90 RS 80 AMGB 39	E135 RS 80 AMGB 39	I90 RS 80 AMGB 39	I135 RS 80 AMGB 39	22.35
10 - 3/8	RS 100 AMGB 39	54.88	E90 RS 100 AMGB 39	E135 RS 100 AMGB 39	I90 RS 100 AMGB 39	I135 RS 100 AMGB 39	22.35
12.5 - 1/2	RS 125 AMGB 39	56.26	E90 RS 125 AMGB 39	E135 RS 125 AMGB 39	I90 RS 125 AMGB 39	I135 RS 125 AMGB 39	22.35
A: 57 mm - 2-1/4"							
8 - 5/16	RS 80 AMGB 57	54.84	E90 RS 80 AMGB 57	E135 RS 80 AMGB 57	I90 RS 80 AMGB 57	I135 RS 80 AMGB 57	22.35
10 - 3/8	RS 100 AMGB 57	55.44	E90 RS 100 AMGB 57	E135 RS 100 AMGB 57	I90 RS 100 AMGB 57	I135 RS 100 AMGB 57	22.35
12.5 - 1/2	RS 125 AMGB 57	56.84	E90 RS 125 AMGB 57	E135 RS 125 AMGB 57	I90 RS 125 AMGB 57	I135 RS 125 AMGB 57	22.35

Length = 2.5 m - 8' 2-1/2"	Brushed antique bronze anod. alu. (ABGB)						
H = mm - in.	Profile	\$ / Length	Outside corner, 90°	Outside corner, 135°	Inside corner, 90°	Inside corner, 135°	\$ / Unit
A: 39 mm - 1-1/2"							
8 - 5/16	RS 80 ABGB 39	54.30	E90 RS 80 ABGB 39	E135 RS 80 ABGB 39	I90 RS 80 ABGB 39	I135 RS 80 ABGB 39	22.35
10 - 3/8	RS 100 ABGB 39	54.88	E90 RS 100 ABGB 39	E135 RS 100 ABGB 39	I90 RS 100 ABGB 39	I135 RS 100 ABGB 39	22.35
12.5 - 1/2	RS 125 ABGB 39	56.26	E90 RS 125 ABGB 39	E135 RS 125 ABGB 39	I90 RS 125 ABGB 39	I135 RS 125 ABGB 39	22.35



Schluter®-SCHIENE-STEP

Schluter®-SCHIENE-STEP is a finishing and edging profile for ceramic tile and natural stone installations on countertops, stairs, and tile over tile applications on walls. The top of the profile features a vertical wall section that finishes and protects the tile from damage, while the vertical leg covers the edge of the sub-assembly, top of the riser, or existing wall tile edge.

SCHIENE-STEP is available in anodized aluminum and brushed stainless steel versions, which have different shapes and intended uses. The stainless steel version is available in three vertical leg lengths: 1-1/2" (39 mm), 1-3/16" (30 mm), and 7/16" (11 mm). The anodized aluminum version is intended for residential stair applications (stairs not exposed to heavy traffic). It is available in two vertical leg lengths, 1-3/16" (30 mm) and 1-1/2" (39 mm). The ribbed vertical leg covers the sub-assembly or top of the riser. The integrated joint spacer establishes a defined joint cavity between the tile and the profile.

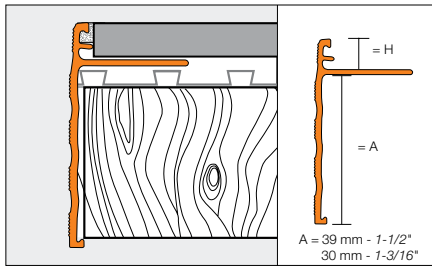
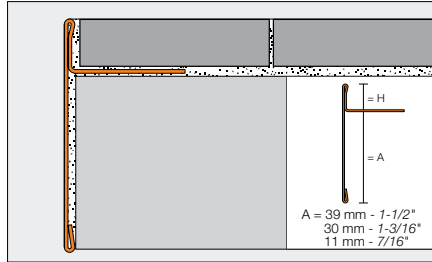

Schluter®-SCHIENE-STEP									
Length = 2.5 m - 8' 2-1/2"		Brushed Stainless Steel 304 (1.4301 = V2A) (EB)							
H = mm - in.	Profile	\$ / Length	Inside corner, 90°	Inside corner, 135°	Outside corner, 90° and End Cap	Outside corner, 135°	\$ / Unit		
A: 39 mm - 1-1/2"									
6 - 1/4	SS 60 EB 39	130.74	I90 / SS 60 EB 39	I135 / SS 60 EB 39	E90 / SS 60 EB 39	E135 / SS 60 EB 39	17.54		
9 - 11/32	SS 90 EB 39	136.16	I90 / SS 90 EB 39	I135 / SS 90 EB 39	E90 / SS 90 EB 39	E135 / SS 90 EB 39	17.54		
11 - 7/16	SS 110 EB 39	137.78	I90 / SS 110 EB 39	I135 / SS 110 EB 39	E90 / SS 110 EB 39	E135 / SS 110 EB 39	17.54		
12.5 - 1/2	SS 125 EB 39	140.79	I90 / SS 125 EB 39	I135 / SS 125 EB 39	E90 / SS 125 EB 39	E135 / SS 125 EB 39	17.54		
A: 30 mm - 1-3/16"									
9 - 11/32	SS 90 EB 30	101.86	-	-	E90 / SS 90 EB 30	-	17.54		
11 - 7/16	SS 110 EB 30	103.11	-	-	E90 / SS 110 EB 30	-	17.54		
12.5 - 1/2	SS 125 EB 30	104.35	-	-	E90 / SS 125 EB 30	-	17.54		
A: 11 mm - 7/16"									
6 - 1/4	SS 60 EB 11	99.96							
12.5 - 1/2	SS 125 EB 11	101.16							

Brushed Stainless Steel 304 (1.4301 = V2A) (EB)		
H = mm - in.	Connector	\$ / Unit
A: 39 mm - 1-1/2"		
6 - 1/4	V / SS 60 EB 39	14.90
9 - 11/32	V / SS 90 EB 39	14.90
11 - 7/16	V / SS 110 EB 39	14.90
12.5 - 1/2	V / SS 125 EB 39	14.90
A: 30 mm - 1-3/16"		
9 - 11/32	V / SS 90 EB 30	14.90
11 - 7/16	V / SS 110 EB 30	14.90
12.5 - 1/2	V / SS 125 EB 30	14.90
A: 11 mm - 7/16"		
6 - 1/4	V / SS 60 EB 11	14.90
12.5 - 1/2	V / SS 125 EB 11	14.90

Schluter®-SCHIENE-STEP				
Length = 2.5 m - 8' 2-1/2"		Satin anodized aluminum (AE)		Satin nickel anodized aluminum (AT)
H = mm - in.	Profile	\$ / Length	Profile	\$ / Length
A: 30 mm - 1-3/16"				
8 - 5/16	SS 80 AE 30	34.03	SS 80 AT 30	37.55
10 - 3/8	SS 100 AE 30	34.57	SS 100 AT 30	37.94
12.5 - 1/2	SS 125 AE 30	35.21	SS 125 AT 30	38.58
15 - 9/16	SS 150 AE 30	35.74	SS 150 AT 30	39.11
A: 39 mm - 1-1/2"				
8 - 5/16	SS 80 AE 39	37.01	SS 80 AT 39	40.38
10 - 3/8	SS 100 AE 39	37.60	SS 100 AT 39	40.96
12.5 - 1/2	SS 125 AE 39	38.14	SS 125 AT 39	41.51
15 - 9/16	SS 150 AE 39	38.71	SS 150 AT 39	42.08

Note: The anchoring leg of Schluter®-SCHIENE-STEP is available with a special radius perforation so that the profile can be used to form curves.

- Available in stainless steel only
- Price surcharge: \$0.60 per foot
- Item No.: R / Profile No. (e.g., R/SS 60 EB 11)
- For delivery time, please call Customer Service





Schluter®-TREP-FL

Schluter®-TREP-FL is a decorative stair-nosing profile with a protruding rounded edge that can be integrated into stairs covered with tile or stone. The profile protects the front edge of stairs and adds a high degree of safety by improving the visibility of the stair edges. The profile is available in stainless steel or anodized aluminum. TREP-FL is suitable for residential applications, e.g., stairs not exposed to heavy traffic.

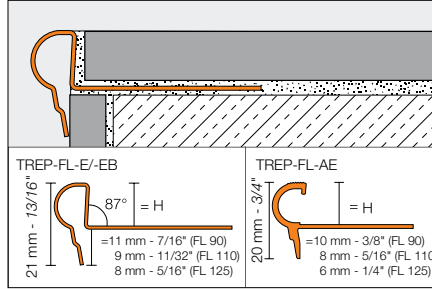

End cap (E/)



Schluter®-TREP-FL		
Stainless steel 304 (1.4301 = V2A) (E)		
H = mm - in.	Item No.	\$ / Length
L = 2.5 m - 8' 2-1/2"		
9 - 11/32	FL 90 E	57.40
11 - 7/16	FL 110 E	59.90
12.5 - 1/2	FL 125 E	62.57
L = 1.50 m - 4' 11"		
9 - 11/32	FL 90 E/150	34.44
11 - 7/16	FL 110 E/150	35.94
12.5 - 1/2	FL 125 E/150	37.55
End cap		\$ / Unit
E/FLEB		4.10

Schluter®-TREP-FL		
Brushed stainless steel 304 (1.4301 = V2A) (EB)		
H = mm - in.	Item No.	\$ / Length
L = 2.5 m - 8' 2-1/2"		
9 - 11/32	FL 90 EB	68.88
11 - 7/16	FL 110 EB	71.88
12.5 - 1/2	FL 125 EB	75.09
L = 1.50 m - 4' 11"		
9 - 11/32	FL 90 EB/150	41.33
11 - 7/16	FL 110 EB/150	43.13
12.5 - 1/2	FL 125 EB/150	45.06
End cap		\$ / Unit
E/FLEB		4.10

Schluter®-TREP-FL		
Satin anodized aluminum (AE)		
H = mm - in.	Item No.	\$ / Length
L = 2.5 m - 8' 2-1/2"		
9 - 11/32	FL 90 AE	31.50
11 - 7/16	FL 110 AE	32.16
12.5 - 1/2	FL 125 AE	32.81
L = 1.50 m - 4' 11"		
9 - 11/32	FL 90 AE/150	22.31
11 - 7/16	FL 110 AE/150	22.71
12.5 - 1/2	FL 125 AE/150	24.41
End cap		\$ / Unit
E/FLAE		1.97



Schluter®-TREP-E

Schluter®-TREP-E is designed to protect tiled stair edges and provide an easily visible, slip-resistant wear surface for durable, safe, and visually appealing stair-nosing design. The profile is made of stainless steel with an integrated non-slip tread, making it suitable for interior and exterior use in areas subjected to heavy foot-traffic, such as offices or public buildings. TREP-E features a trapezoid-perforated anchoring leg that is secured in the bond coat beneath the tile.

Note: Sizes 80, 110, and 160 are also available in stainless steel 316L (1.4404 = V4A). Contact Customer Service for pricing and availability.

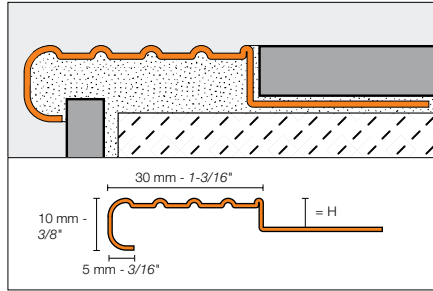

A version without the anchoring leg for retrofit applications is also available. Please refer to TREP-EK on page 63.

Schluter®-TREP-E		
Stainless steel 304 (1.4301 = V2A) (E)		
H = mm - in.	Item No.	\$ / Length
L = 2.5 m - 8' 2-1/2"		
2 - 3/32	TE 20	47.87
5 - 3/16	TE 50	49.50
8 - 5/16	TE 80	51.04
11 - 7/16	TE 110	52.48
16 - 5/8	TE 160	55.07
25 - 1	TE 250	59.79
L = 1.50 m - 4' 11"		
2 - 3/32	TE 20/150	29.90
5 - 3/16	TE 50/150	30.94
8 - 5/16	TE 80/150	31.89
11 - 7/16	TE 110/150	32.80
16 - 5/8	TE 160/150	34.42
25 - 1	TE 250/150	37.37
End cap		\$ / Unit
E/TE		2.81

End cap (E/)





Schluter®-TREP-G

Schluter®-TREP-G is designed to protect tiled stair edges and provide an easily visible, slip-resistant wear surface for durable, safe, and visually appealing stair-nosing design. The profile is made of stainless steel, making it suitable for interior and exterior use in areas subjected to heavy foot-traffic, such as offices or public buildings. The surface features a self-adhesive, non-slip tread with an embedded mineral grain coating, which is available in a variety of colors and can be replaced in case of damage or wear. TREP-G features a trapezoid-perforated anchoring leg that is secured in the bond coat beneath the tile.

Note: Sizes 130 and 150 are not stocked. Please call Customer Service for delivery times.



A version without the anchoring leg for retrofit applications is also available. Please refer to TREP-GK on page 64.

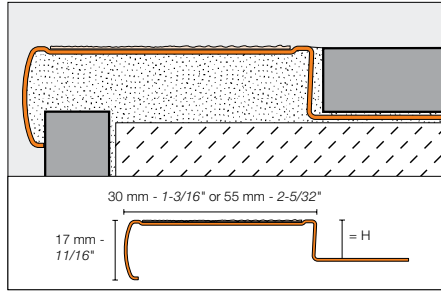

Schluter®-TREP-G-S		
Brushed stainless steel support with non-slip tread (30 mm - 1-3/16")		
H = mm - in.	Item No.	\$ / Length
L = 2.5 m - 8' 2-1/2"		
9 - 11/32	GS EB 90 + color*	124.29
11 - 7/16	GS EB 110 + color*	125.63
13 - 33/64	GS EB 130 + color*	126.96
15 - 9/16	GS EB 150 + color*	129.11
L = 1.50 m - 4' 11"		
9 - 11/32	GS EB 90 + color*/150	78.73
11 - 7/16	GS EB 110 + color*/150	79.56
13 - 33/64	GS EB 130 + color*/150	80.41
15 - 9/16	GS EB 150 + color*/150	81.63
Replacement tread		
L = 18.3 m - 60' 1/32"		\$ / Unit
GS KB 183 + color*		136.97
End cap		\$ / Unit
E/GS EB		4.23

Schluter®-TREP-G-B		
Brushed stainless steel support with non-slip tread (55 mm - 2-5/32")		
H = mm - in.	Item No.	\$ / Length
L = 2.5 m - 8' 2-1/2"		
9 - 11/32	GB EB 90 + color*	159.47
11 - 7/16	GB EB 110 + color*	160.59
13 - 33/64	GB EB 130 + color*	161.93
15 - 9/16	GB EB 150 + color*	163.26
L = 1.50 m - 4' 11"		
9 - 11/32	GB EB 90 + color*/150	100.44
11 - 7/16	GB EB 110 + color*/150	101.15
13 - 33/64	GB EB 130 + color*/150	101.99
15 - 9/16	GB EB 150 + color*/150	102.84
Replacement tread		
L = 18.3 m - 60' 1/32"		\$ / Unit
GB KB 183 + color*		246.84
End cap		\$ / Unit
E/GB EB		4.23

***Color Codes (-G)**

CG Yellow	GS Black	NB Nut brown	T Transparent
-----------	----------	--------------	---------------

* To complete the item number, add the color code (e.g., GS EB 90 GS).





Schluter®-TREP-SE/-S/-B

Schluter®-TREP-SE/-S/-B are designed to protect tiled stair edges and provide an easily visible, slip-resistant wear surface for durable, safe, and visually appealing stair-nosing design. They are suitable for use in areas subjected to heavy foot-traffic, such as offices or public buildings. The profiles feature a trapezoid-perforated anchoring leg made of stainless steel (-SE) or aluminum (-S and -B), with a slip-resistant, thermoplastic rubber wear surface. The tread surface is available in a variety of colors and can be replaced in case of damage or wear.

Note: Radius of leading edge for TREP-S and TREP-B: 8 mm - 5/16".

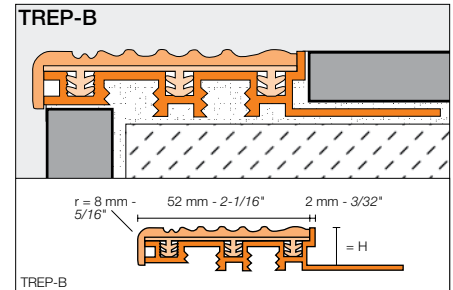
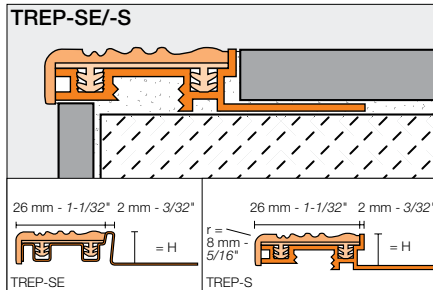
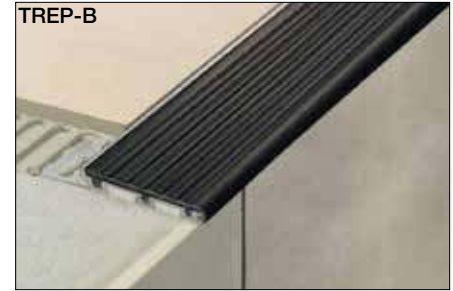

Schluter®-TREP-SE		
Stainless steel support with thermoplastic rubber insert (26 mm - 1-1/32")		
H = mm - in.	Item No.	\$ / Length
L = 2.5 m - 8' 2-1/2"		
8 - 5/16	color* + 8 SE	83.17
10 - 3/8	color* + 10 SE	85.76
12.5 - 1/2	color* + 12 SE	88.20
L = 1.50 m - 4' 11"		
8 - 5/16	color* + 8 SE/150	51.99
10 - 3/8	color* + 10 SE/150	53.79
12.5 - 1/2	color* + 12 SE/150	55.13
Stainless steel support section		
L = 2.5 m - 8' 2-1/2"		
8 - 5/16	TES 8	64.22
10 - 3/8	TES 10	66.83
12.5 - 1/2	TES 12	69.25
L = 1.50 m - 4' 11"		
8 - 5/16	TES 8/150	36.46
10 - 3/8	TES 10/150	36.87
12.5 - 1/2	TES 12/150	37.83
Replacement thermoplastic rubber insert		
L = 2.5 m - 8' 2-1/2"		
	PE 26/+ color*	18.95
L = 3 m - 9' 10"		
	PE 26/+ color*/300	23.69
End cap		
	E 26/+ color*	1.82

Schluter®-TREP-S		
Aluminum support with thermoplastic rubber insert (26 mm - 1-1/32")		
H = mm - in.	Item No.	\$ / Length
L = 2.5 m - 8' 2-1/2"		
8 - 5/16	color* + 8 S	51.86
10 - 3/8	color* + 10 S	53.87
12.5 - 1/2	color* + 12 S	57.26
L = 1.50 m - 4' 11"		
8 - 5/16	color* + 8 S/150	34.53
10 - 3/8	color* + 10 S/150	35.78
12.5 - 1/2	color* + 12 S/150	36.60
Aluminum support section		
L = 2.5 m - 8' 2-1/2"		
8 - 5/16	TAS 8	32.92
10 - 3/8	TAS 10	34.90
12.5 - 1/2	TAS 12	38.29
L = 1.50 m - 4' 11"		
8 - 5/16	TAS 8/150	16.46
10 - 3/8	TAS 10/150	17.45
12.5 - 1/2	TAS 12/150	19.15
Replacement thermoplastic rubber insert		
L = 2.5 m - 8' 2-1/2"		
	PEA 26/+ color*	18.95
L = 3 m - 9' 10"		
	PEA 26/+ color*/300	23.69
L = 15 m - 50'		
	PEA 26/+ color*/50	118.45
End cap		
	E 26/+ color*	1.82

Schluter®-TREP-B		
Aluminum support with thermoplastic rubber insert (52 mm - 2-1/16")		
H = mm - in.	Item No.	\$ / Length
L = 2.5 m - 8' 2-1/2"		
8 - 5/16	color* + 8 B	78.10
10 - 3/8	color* + 10 B	82.78
12.5 - 1/2	color* + 12 B	86.48
15 - 9/16	color* + 15 B	91.16
25 - 1	color* + 25 B	93.26
L = 1.50 m - 4' 11"		
8 - 5/16	color* + 8 B/150	48.81
10 - 3/8	color* + 10 B/150	51.74
12.5 - 1/2	color* + 12 B/150	54.05
15 - 9/16	color* + 15 B/150	56.98
25 - 1	color* + 25 B/150	58.29
Aluminum support section		
L = 2.5 m - 8' 2-1/2"		
8 - 5/16	TAB 8	47.47
10 - 3/8	TAB 10	52.16
12.5 - 1/2	TAB 12	55.86
15 - 9/16	TAB 15	60.53
25 - 1	TAB 25	62.63
L = 1.50 m - 4' 11"		
8 - 5/16	TAB 8/150	23.74
10 - 3/8	TAB 10/150	26.08
12.5 - 1/2	TAB 12/150	27.93
15 - 9/16	TAB 15/150	30.27
25 - 1	TAB 25/150	31.32
Replacement thermoplastic rubber insert		
L = 2.5 m - 8' 2-1/2"		
	PEA 52/+ color*	30.63
L = 3 m - 9' 10"		
	PEA 52/+ color*/300	38.09
L = 15 m - 50'		
	PEA 52/+ color*/50	190.98
End cap		
	E 52/+ color*	1.87

***Color Codes (-SE/-S/-B)**

	CG Yellow		G Grey		HB Light beige		NB Nut brown
	GS Black						

* To complete the item number, add the color code (e.g., G 10 SE).





Schluter®-TREP-TAP

Schluter®-TREP-TAP is an anodized aluminum cover profile that integrates with the Schluter®-TREP-S/-B stair-nosing profiles (page 61) to conceal the top of the riser. There are two options available: a 2-13/32" (61 mm) version featuring horizontal grooves, and a 2" (50 mm) version with a smooth surface finish.



Schluter®-TREP-TAP	
Satin anodized aluminum (AE)	
Item No.	\$ / Length
50 mm - 2" Smooth	
L = 2.5 m - 8' 2-1/2"	
TAP 50 AE	30.45
L = 1.50 m - 4' 11"	
TAP 50 AE/150	19.95
L = 1.00 m - 3' 3"	
TAP 50 AE/100	14.70
61 mm - 2-13/32" Grooved	
L = 2.5 m - 8' 2-1/2"	
TAPR 61 AE	31.36
L = 1.50 m - 4' 11"	
TAPR 61 AE/150	19.13

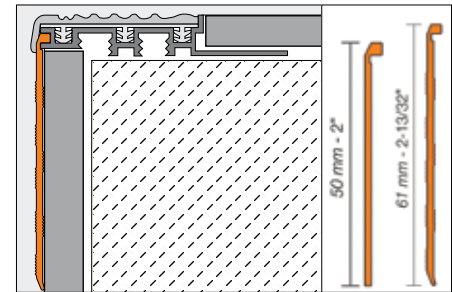



Safety can be retrofitted



The installation of stair nosing profiles is not always a consideration during the initial construction of stairs. Schluter®-TREP profiles are also available for retrofit installation to help you enhance the safety of stairs at a later point. Schluter®-KERDI-FIX ensures the secure installation of these profiles:

- Schluter®-TREP-EK with slip-resistant wear surface
- Schluter®-TREP-EFK for bonding in milled grooves
- Schluter®-TREP-GK with replaceable, self-adhesive non-slip tread

Schluter®-TREP-EK

Schluter®-TREP-EK is designed to protect tiled stair edges and provide an easily visible, slip-resistant wear surface for durable, safe, and visually appealing stair-nosing design. The profile is made of stainless steel with an integrated non-slip tread, making it suitable for interior and exterior use in areas subjected to heavy foot-traffic, such as offices or public buildings.

TREP-EK is subsequently bonded to existing installations. As such, TREP-EK can be installed as a repair so that existing, damaged stair treads do not have to be replaced.

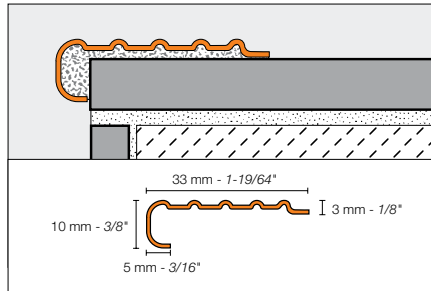

Schluter®-TREP-EK	
Stainless steel 304 (1.4301 = V2A) (E)	
Item No.	\$ / Length
L = 2.5 m - 8' 2-1/2"	
TEK	40.46
L = 1.50 m - 4' 11"	
TEK/150	24.28

Schluter®-TREP-EFK

Schluter®-TREP-EFK is a retrofit stainless steel stair profile which is bonded to existing steps. The stair profile features an easily visible, slip-resistant wear surface for durable and safe stairs. The profile is suitable for interior and exterior use in areas subjected to heavy foot traffic, such as offices or public buildings.

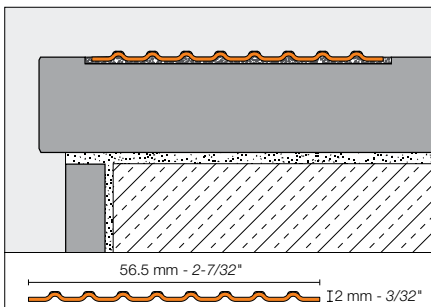

Schluter®-TREP-EFK	
Stainless steel 316L (1.4404 = V4A) (E)	
Item No.	\$ / Length
L = 2.5 m - 8' 2-1/2"	
TEF56K/V4A	68.25



Schluter®-TREP-GK



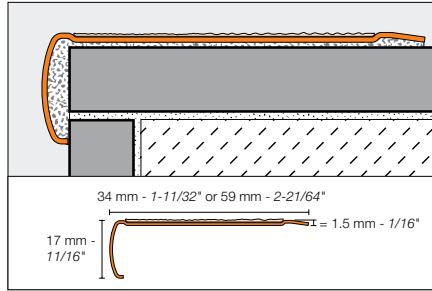

Schluter®-TREP-GK is designed to protect tiled stair edges and provide an easily visible, slip-resistant wear surface for durable, safe, and visually appealing stair-nosing design. The profile is made of stainless steel, making it suitable for interior and exterior use in areas subjected to heavy foot-traffic, such as offices or public buildings. The surface features a self-adhesive, non-slip tread with an embedded mineral grain coating, which is available in a variety of colors and can be replaced in case of damage or wear.

TREP-GK is subsequently bonded to existing installations. As such, TREP-GK can be installed as a repair so that existing, damaged stair treads do not have to be replaced.



Schluter®-TREP-GK-S	
Brushed stainless steel support with non-slip tread (34 mm - 1-11/32")	
Item No.	\$ / Length
L = 2.5 m - 8' 2-1/2"	
GS EBK + color*	105.12
L = 1.50 m - 4' 11"	
GS EBK + color*/150	66.64
Replacement tread	
L = 18.3 m - 60' 1/32"	
GS KB 183 + color*	\$ / Unit 136.97

Schluter®-TREP-GK-B	
Brushed stainless steel support with non-slip tread (59 mm - 2-21/64")	
Item No.	\$ / Length
L = 2.5 m - 8' 2-1/2"	
GB EBK + color*	140.08
L = 1.50 m - 4' 11"	
GB EBK + color*/150	88.22
Replacement tread	
L = 18.3 m - 60' 1/32"	
GB KB 183 + color*	\$ / Unit 246.84

*Color Codes (-GK)			
 CG Yellow	 GS Black	 NB Nut brown	 T Transparent
* To complete the item number, add the color code (e.g., GS EBK CG).			



Schluter®-Profiles

MOVEMENT JOINT AND COVE-SHAPED PROFILES

An installed ceramic tile floor is rigid by nature and similar in physical characteristics to a large sheet of glass. This is particularly true with today's large-format tiles and narrow joint design. Stress buildup occurs within large surfaces and at perimeters, causing cracking and loosening of the tile covering. In addition, caulking is often used to create a movement zone. Unfortunately, caulking material has a limited lifespan and eventually breaks down, leaving the tiled edges exposed and vulnerable to damage.

Expansion joints must be incorporated within large surfaces, at doorsills, and at transitions to walls and other restraining structures to allow movement and thus reduce stress buildup. Schluter®-Systems' prefabricated movement joint profiles eliminate the need for caulking, protect tile edges, and prevent sound bridges and surface water penetration, resulting in a permanent, maintenance-free installation. The family of Schluter®-DILEX prefabricated movement joints includes a variety of shapes, sizes, and materials to suit different applications.



Schluter®-DILEX-MOP

Schluter®-DILEX-MOP is a screed joint profile with rigid PVC side sections that protect tile edges and a soft PVC movement zone that separates individual fields in the tile assembly and forms the visible surface. DILEX-MOP is designed to provide movement joints in tile installations that are set in a mortar bed (e.g., ceramic tile, natural stone, pavers, and agglomerate tile).

Note: Available only in grey.

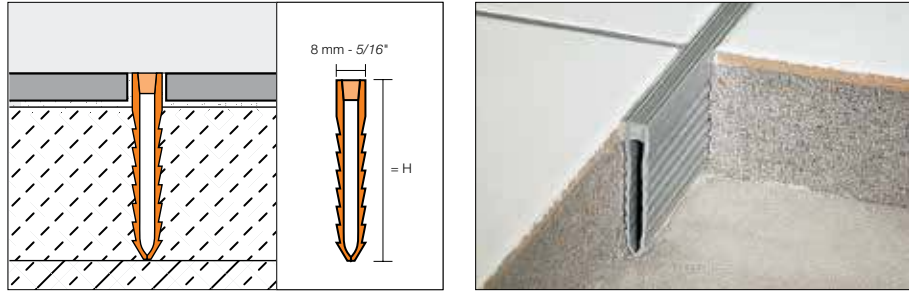

Schluter®-DILEX-MOP		
Length = 2.5 m - 8' 2-1/2"	Screed joint profile	
H = mm - in.	Item No.	\$ / Length
35 - 1-3/8	MOP 35 G	18.25
50 - 2	MOP 50 G	23.34
65 - 2-5/8	MOP 65 G	27.13

Schluter®-DILEX-MP/-MPV

Schluter®-DILEX-MP is a screed joint profile with rigid PVC side sections that protect tile edges and a soft chlorinated polyethylene (CPE) movement zone that separates individual fields in the tile assembly and forms the visible surface. The movement zone is available in different colors to match the grout. DILEX-MP is designed to provide movement joints in tile installations that are set in a mortar bed (e.g., ceramic tile, natural stone, pavers, and agglomerate tile). DILEX-MP adjusts to the thickness of the mortar bed and tile surface by attaching the DILEX-MPV extensions.

***Color Codes**

	HB Light beige		G Grey		ZR Brick red		GS Black
--	--------------------------	--	------------------	--	------------------------	--	--------------------

* To complete the item number, add the **color** code (e.g., MP 35 **G**).

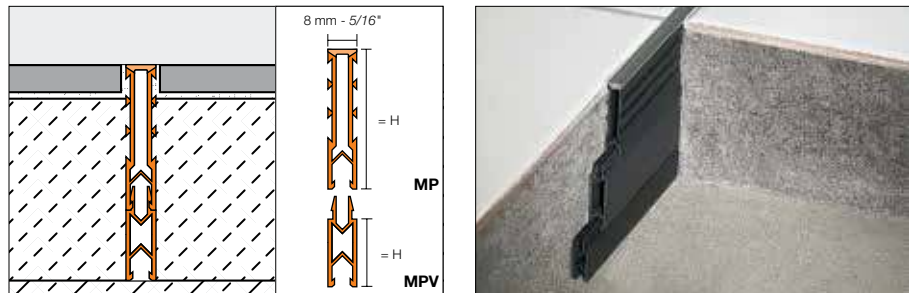

Schluter®-DILEX-MP		
Length = 2.5 m - 8' 2-1/2"	Screed joint profile	
H = mm - in.	Item No.	\$ / Length
35 - 1-3/8	MP 35 + color*	21.55



Schluter®-DILEX-MPV		
Length = 2.5 m - 8' 2-1/2"	Extension profile	
H = mm - in.	Item No.	\$ / Length
15 - 9/16	MPV 15	14.57
25 - 1	MPV 25	15.66

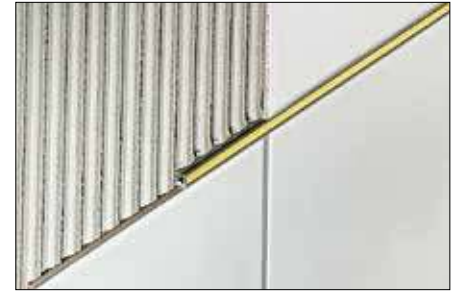
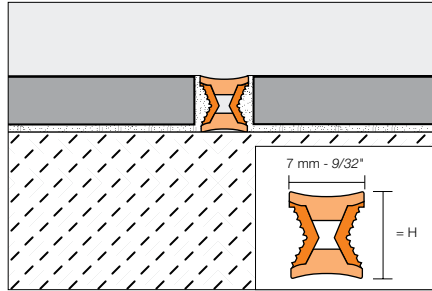

Schluter®-DILEX-EZ 6 + 9

Schluter®-DILEX-EZ 6 and **9** combine decorative design with stress-relieving function for tile and stone set in a thin bed of adhesive. The profile features two usable surfaces in different colors. The sidewalls are made of rigid PVC; the movement zones are made of soft PVC.







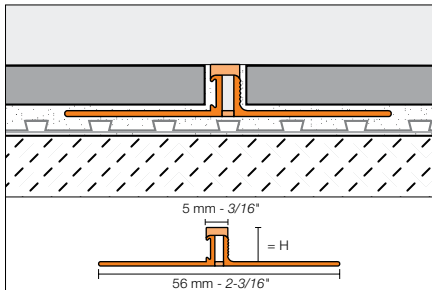

*Color Codes	
 G Grey	 CG Yellow
M/G = Brass inlay / grey	
C/CG = Chrome inlay / yellow	

Schluter®-DILEX-EZ 6 + 9			
Length = 2.5 m - 8' 2-1/2"	Decorative movement joint		
H = mm - in.	Item No.		\$/ Length
6 - 1/4	EZ M/G 6		17.45
6 - 1/4	EZ C/CG 6		17.45
9 - 11/32	EZ M/G 9		20.84
9 - 11/32	EZ C/CG 9		20.84

Schluter®-DILEX-BWS

Schluter®-DILEX-BWS is a surface joint profile with rigid PVC anchoring legs that protect tile edges and a 3/16" (5 mm)-wide, soft CPE movement zone that separates individual fields in the tile covering and forms the visible surface. The movement zone is available in different colors to match the grout. The profile absorbs relatively limited movements and may be installed with greater frequency to create smaller fields, or the Schluter®-DILEX-BWB (3/8" - 10 mm movement zone) may be used. DILEX-BWS is suitable for residential to medium-duty commercial applications subject to light mechanical loads (e.g., offices and stores). The profile is also suited for exterior use.



*Color Codes			
 BW Bright white	 SP Sand pebble	 HB Light beige	 PG Classic grey
 G Grey	 GS Black		
* To complete the item number, add the color code (e.g., BWS 80 G).			

Schluter®-DILEX-BWS			
Length = 2.5 m - 8' 2-1/2"	PVC surface joint profile (5 mm - 3/16")		
H = mm - in.	Item No.		\$/ Length
4.5 - 3/16	BWS 45 + color*		18.45
6 - 1/4	BWS 60 + color*		18.45
8 - 5/16	BWS 80 + color*		18.45
9 - 11/32	BWS 90 + color*		19.41
10 - 3/8	BWS 100 + color*		19.41
11 - 7/16	BWS 110 + color*		19.41
12.5 - 1/2	BWS 125 + color*		19.41



Schluter®-DILEX-BWB

Schluter®-DILEX-BWB is a surface joint profile with rigid PVC anchoring legs that protect tile edges and a 3/8" (10 mm)-wide, soft CPE movement zone that separates individual fields in the tile covering and forms the visible surface. The movement zone is available in different colors to match the grout. DILEX-BWB is suitable for residential to medium-duty commercial applications subject to light mechanical loads (e.g., offices and stores). The profile is also suited for exterior use.

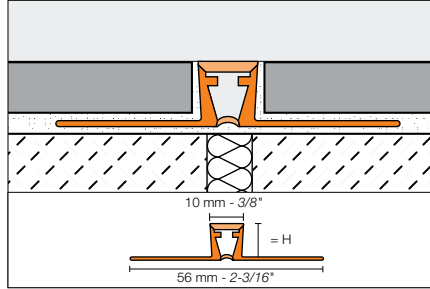

***Color Codes**

BW Bright white	SP Sand pebble	HB Light beige	PG Classic grey
G Grey	GS Black		

* To complete the item number, add the **color** code (e.g., BWB 80 **G**).

** BWB 60 is not available in sand pebble (SP).

Schluter®-DILEX-BWB			
Length = 2.5 m - 8' 2-1/2"	PVC surface joint profile (10 mm - 3/8")		
H = mm - in.	Item No.	\$ / Length	
6 - 1/4	BWB 60 + color**	20.09	
8 - 5/16	BWB 80 + color*	20.66	
10 - 3/8	BWB 100 + color*	21.63	
12.5 - 1/2	BWB 125 + color*	21.63	
15 - 9/16	BWB 150 G (Grey only)	25.02	
20 - 3/4	BWB 200 G (Grey only)	26.79	

Schluter®-DILEX-EDP

Schluter®-DILEX-EDP is a stainless steel surface joint profile that protects tile edges and separates individual fields in the tile covering. The profile accommodates horizontal movement via the 15/32" (12 mm)-wide stainless steel tongue-and-groove connection, which also forms the visible surface. DILEX-EDP is particularly suited for tile surfaces subject to heavy use, including areas exposed to continuous vehicular traffic. The profile is, therefore, suited for use in production facilities, warehouses, shopping centers, and underground parking garages, or for floor surfaces maintained with cleaning machines.

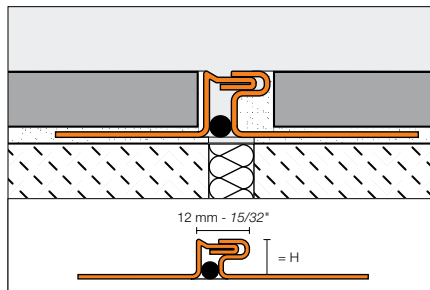

Schluter®-DILEX-EDP			
Length = 2.5 m - 8' 2-1/2"	Stainless steel 304 (1.4301 = V2A) (E)		
H = mm - in.	Item No.	\$ / Length	
8 - 5/16	EDP 80	106.52	
9 - 11/32	EDP 90	108.12	
10 - 3/8	EDP 100	109.21	
11 - 7/16	EDP 110	110.22	
12.5 - 1/2	EDP 125	112.11	
14 - 17/32	EDP 140	113.70	
16 - 5/8	EDP 160	116.30	
18.5 - 23/32	EDP 185	119.08	
21 - 13/16	EDP 210	121.78	
25 - 1	EDP 250	126.78	
30 - 1-3/16	EDP 300	132.55	



Schluter®-DILEX-KSN

Schluter®-DILEX-KSN is a surface joint profile with stainless steel or aluminum anchoring legs that protect tile edges and a 7/16" (11 mm)-wide, soft thermoplastic rubber movement zone that separates individual fields in the tile covering and forms the visible surface. The movement zone is available in different colors to match the grout and can be replaced if damaged. DILEX-KSN in stainless steel offers secure edge protection for surfaces exposed to heavy-duty commercial traffic (e.g., warehouses, production facilities, or shopping malls).

Note: DILEX-KSN is also available in stainless steel 316L (1.4404 = V4A). Contact Customer Service for price and availability.

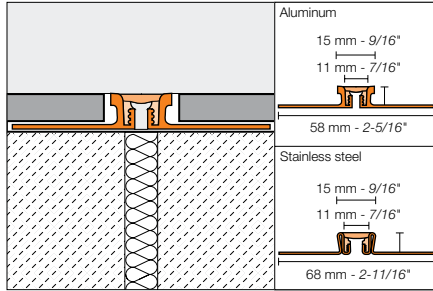

*Color Codes

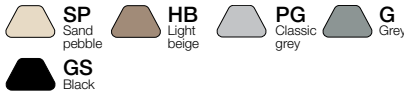

* To complete the item number, add the **color** code (e.g., AKSN 125 **G**).

Schluter®-DILEX-KSN				
Length = 2.5 m - 8' 2-1/2"	Stainless steel 304 (1.4301 = V2A) (E)		Aluminum (A)	
H = mm - in.	Item No.	\$/ Length	Item No.	\$/ Length
8 - 5/16	EKSN 80 + color *	97.56	AKSN 80 + color *	44.79
10 - 3/8	EKSN 100 + color *	116.60	AKSN 100 + color *	46.71
11 - 7/16	EKSN 110 + color *	117.77	AKSN 110 + color *	47.65
12.5 - 1/2	EKSN 125 + color *	120.09	AKSN 125 + color *	48.64
14 - 17/32	EKSN 140 + color *	122.18	AKSN 140 + color *	49.98
16 - 5/8	EKSN 160 + color *	125.67	AKSN 160 + color *	51.89
18.5 - 23/32	EKSN 185 + color *	128.46	-	-
21 - 13/16	EKSN 210 + color *	131.95	AKSN 210 + color *	57.09
25 - 1	EKSN 250 + color *	138.24	-	-
30 - 1-3/16	EKSN 300 + color *	144.52	-	-
Rubber insert replacement			KSE/ + color *	15.67

Schluter®-DILEX-EKSB

Schluter®-DILEX-EKSB is a surface joint profile for thinner floor coverings (e.g., VCT flooring or coatings) with stainless steel anchoring legs and a 1/4" (6 mm)-wide, soft thermoplastic rubber movement zone that separates individual fields in the floor covering and forms the visible surface. The movement zone is available in different colors. DILEX-EKSB is suitable for residential to medium-duty commercial applications.

Note: DILEX-EKSB is also available in stainless steel 316L (1.4404 = V4A). Contact Customer Service for price and availability.

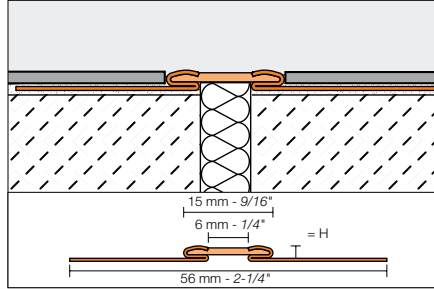

***Color Codes**



* To complete the item number, add the **color** code (e.g., EKSB 60 **G**).

Schluter®-DILEX-EKSB		
Length = 2.5 m - 8' 2-1/2"	Stainless steel 304 (1.4301 = V2A) (E)	
H = mm - in.	Item No.	\$ / Length
2.5 - 3/32	EKSB 25 + color*	87.28
4.5 - 3/16	EKSB 45 + color*	92.16
6 - 1/4	EKSB 60 + color*	95.96

Schluter®-DILEX-AKWS

Schluter®-DILEX-AKWS is a surface joint profile with aluminum anchoring legs that protect tile edges and a 1/4" (6 mm)-wide, soft PVC movement zone that separates individual fields in the tile covering and forms the visible surface. The movement zone is available in different colors to match the grout. DILEX-AKWS is suitable for residential to medium-duty commercial applications, such as areas subject to moderate mechanical stresses, including light vehicular traffic.

An adhesive strip on the back of the profile ensures that the movement zone remains free of mortar during installation.

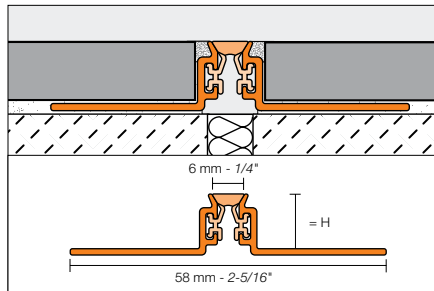

***Color Codes**

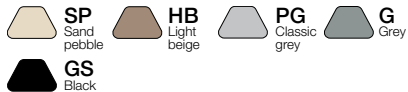

* To complete the item number, add the **color** code (e.g., AKWS 80 **G**).

Schluter®-DILEX-AKWS		
Length = 2.5 m - 8' 2-1/2"	Aluminum (A)	
H = mm - in.	Item No.	\$ / Length
8 - 5/16	AKWS 80 + color*	33.17
9 - 11/32	AKWS 90 + color*	33.93
10 - 3/8	AKWS 100 + color*	34.69
11 - 7/16	AKWS 110 + color*	36.14
12.5 - 1/2	AKWS 125 + color*	39.22
14 - 17/32	AKWS 140 + color*	42.20
16 - 5/8	AKWS 160 + color*	45.18
21 - 13/16	AKWS 210 + color*	50.46



Schluter®-DILEX-BT

Schluter®-DILEX-BT is an expansion joint profile made of anodized aluminum that bridges expansion joints and accommodates movement via the 1-3/16" (30 mm)-wide telescopic center section, which also forms the visible surface. DILEX-BT protects tile edges and is suitable for tile surfaces exposed to foot traffic as well as vehicular traffic and is, therefore, suited for use in warehouses, production facilities, shopping centers, airports, train stations, and parking garages, or for coverings cleaned with machines.

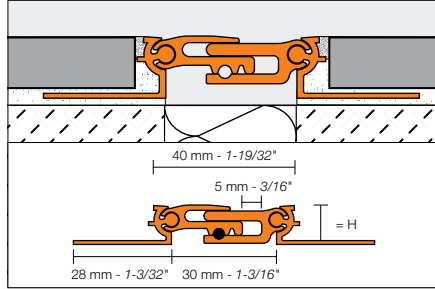

Schluter®-DILEX-BT		
Length = 2.5 m - 8' 2-1/2"	Satin anodized aluminum (AE)	
H = mm - in.	Item No.	\$/ Length
8 - 5/16	AEBT 80	159.18
10 - 3/8	AEBT 100	161.87
12.5 - 1/2	AEBT 125	164.86
15 - 9/16	AEBT 150	167.57
17.5 - 11/16	AEBT 175	170.95
20 - 3/4	AEBT 200	179.53

Schluter®-DILEX-BTO

Schluter®-DILEX-BTO is an expansion joint profile made of anodized aluminum that bridges expansion joints at floor/wall transitions and accommodates movement via the 1-3/16" (30 mm)-wide telescopic center section, which also forms the visible surface. DILEX-BTO protects tile edges and is suitable for tile surfaces exposed to foot traffic as well as vehicular traffic and is, therefore, suited for use in warehouses, production facilities, shopping centers, airports, train stations, and parking garages, or for coverings cleaned with machines.

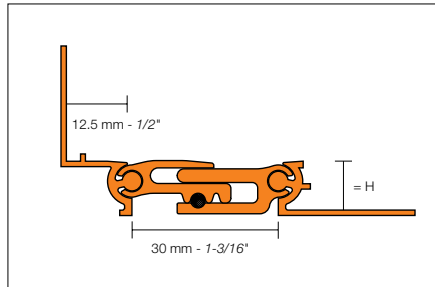

Schluter®-DILEX-BTO		
Length = 2.5 m - 8' 2-1/2"	Satin anodized aluminum (AE)	
H = mm - in.	Item No.	\$/ Length
8 - 5/16	AEBT 80/O 125	164.18
10 - 3/8	AEBT 100/O 125	165.47
12.5 - 1/2	AEBT 125/O 125	166.96
15 - 9/16	AEBT 150/O 125	168.36
17.5 - 11/16	AEBT 175/O 125	170.27
20 - 3/4	AEBT 200/O 125	174.45

Schluter®-DILEX-BTS

Schluter®-DILEX-BTS is an expansion joint profile made of anodized aluminum that bridges expansion joints and accommodates movement via the 1-3/16" (30 mm)-wide telescopic center section, which also forms the visible surface. The profile is installed in completed tile coverings. DILEX-BTS protects tile edges and is suitable for tile surfaces exposed to foot traffic as well as vehicular traffic and is, therefore, suited for use in warehouses, production facilities, shopping centers, airports, train stations, and parking garages, or for coverings cleaned with machines.

Note: DILEX-BTS can be inserted into existing joint spaces. The joints must be at least 1-3/4" (44 mm) wide and 3/8" (10 mm) deep.

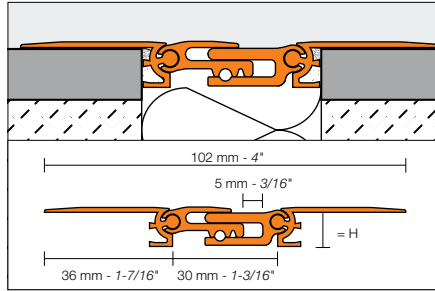

Schluter®-DILEX-BTS		
Length = 2.5 m - 8' 2-1/2"	Satin anodized aluminum (AE)	
H = mm - in.	Item No.	\$ / Length
10 - 3/8	AEBTS 100	164.86

Schluter®-DILEX-AS

Schluter®-DILEX-AS is a perimeter joint profile with a rigid PVC anchoring leg and a flexible joining leg with self-adhesive tape to bond the profile to fixed building elements (e.g., bathtubs, shower trays, door and window frames). DILEX-AS isolates the tile covering from the fixed building element and accommodates movement via the flexible joining leg, which also forms the visible surface. Suitable for tiles 3/16" to 3/8" (4 - 10 mm) thick.

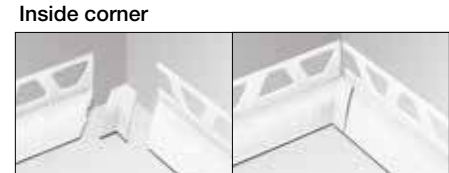
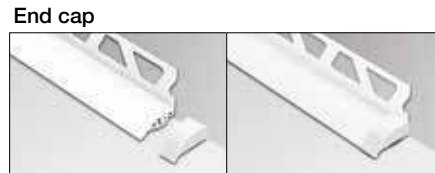
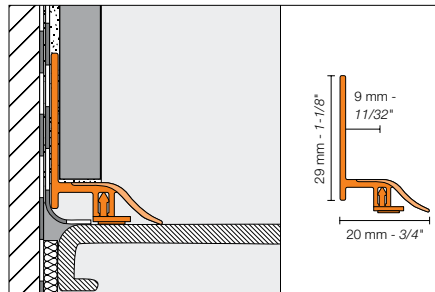

Color Code	
	BW Bright white

Schluter®-DILEX-AS								
Length = 2.5 m - 8' 2-1/2"	PVC perimeter joint profile							
H = mm - in.	Profile	\$ / Length	End cap (Right)	End cap (Left)	Inside corner	\$ / Unit	2 inside corners + 1 right end cap + 1 left end cap	\$ / Set
9 - 11/32	AS20BW	26.61	EKR/AS20BW	EKL/AS20BW	I/AS20BW	3.17	EKI/AS20BW	11.48



Schluter®-DILEX-BWA

Schluter®-DILEX-BWA is a perimeter joint profile with a rigid PVC anchoring leg and a 3/16" (5 mm)-wide, soft CPE movement zone that isolates the tile covering from fixed building elements (e.g., bathtubs, shower trays, door and window frames) and forms the visible surface. The movement zone is available in different colors to match the grout. The profile also features a dovetailed channel made of rigid PVC that can be bonded to the fixed building elements.

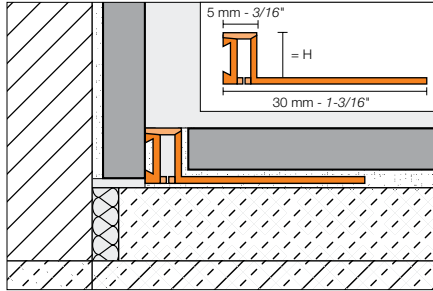

*Color Codes



* To complete the item number, add the **color** code (e.g., BWA 80 **G**).

** BWA 45 is not available in Sand Pebble (SP)

Schluter®-DILEX-BWA

Length = 2.5 m - 8' 2-1/2"	PVC perimeter joint profile		
H = mm - in.	Item No.		\$/ Length
4.5 - 3/16	BWA 45 + color**		20.18
6 - 1/4	BWA 60 + color*		21.54
8 - 5/16	BWA 80 + color*		22.88
10 - 3/8	BWA 100 + color*		23.55
12.5 - 1/2	BWA 125 + color*		24.22

Schluter®-DILEX-KSA

Schluter®-DILEX-KSA is a perimeter joint profile with a stainless steel or aluminum anchoring leg and a 3/8" (10 mm)-wide, soft thermoplastic rubber movement zone that isolates the tile covering from fixed building elements (e.g., window and door frames). The movement zone is available in different colors to match the grout and can be replaced if damaged. The profile also features a self-adhesive strip that allows it to bond to the fixed building elements.

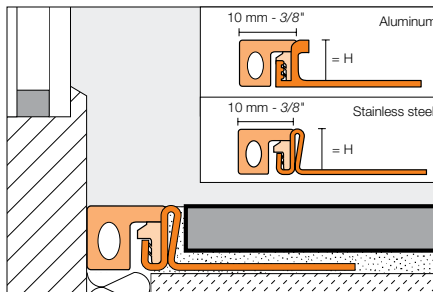

Note: DILEX-KSA is also available in stainless steel 316L (1.4404 = V4A). Contact Customer Service for price and availability.

Schluter®-DILEX-KSA

Length = 2.5 m - 8' 2-1/2"	Stainless steel 304 (1.4301 = V2A) (E)		Aluminum (A)	
H = mm - in.	Item No.	\$/ Length	Item No.	\$/ Length
8 - 5/16	EKSA 80 + color*	59.69	AKSA 80 + color*	33.23
10 - 3/8	EKSA 100 + color*	72.75	AKSA 100 + color*	34.15
11 - 7/16	EKSA 110 + color*	73.48	AKSA 110 + color*	34.73
12.5 - 1/2	EKSA 125 + color*	74.95	AKSA 125 + color*	35.28
14 - 17/32	EKSA 140 + color*	76.24	AKSA 140 + color*	36.79
16 - 5/8	EKSA 160 + color*	78.42	-	-
18.5 - 23/32	EKSA 185 + color*	80.17	-	-
21 - 13/16	EKSA 210 + color*	82.34	-	-
25 - 1	EKSA 250 + color*	86.27	-	-
30 - 1-3/16	EKSA 300 + color*	90.20	-	-
Rubber insert replacement			KSAE/+ color*	15.36

*Color Codes



* To complete the item number, add the **color** code (e.g., EKSA 80 **G**).

Schluter®-DILEX-EKE

Schluter®-DILEX-EKE is a corner movement joint profile with rigid PVC anchoring legs and a 3/16" (5 mm)-wide, soft CPE movement zone that separates individual tile fields at floor/wall transitions and inside wall corners and forms the visible surface. The movement zone is available in different colors to match the grout and forms a discreet, uniform joint. DILEX-EKE prevents surface water penetration and prevents sound bridges, making it ideal for floor/wall transitions in sound-rated floors.

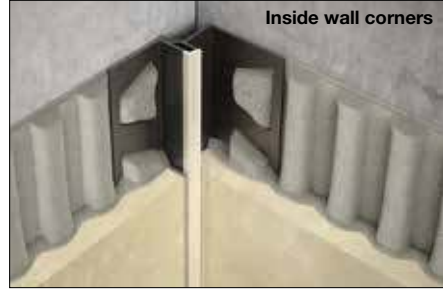
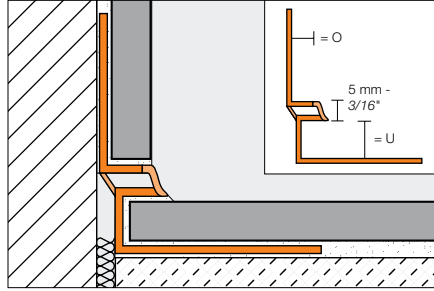

***Color Codes**

BW Bright white	SP Sand pebble	HB Light beige	PG Classic grey
G Grey	GS Black		

* To complete the item number, add the **color** code (e.g., EKE U 8 / O / 7 **BW**).

Schluter®-DILEX-EKE	
Corner movement profile	
Length = 2.5 m - 8' 2-1/2"	
U = floor or wall, O = wall	
	\$ / Length
EKE U 8/O 7 + color*	19.40
EKE U 9/O 8 + color*	19.90
EKE U 11/O 10 + color*	20.09
EKE U 13/O 12 + color*	20.69
EKE U 15/O 14 + color*	21.15

Get perfect cuts!



Schluter®-SNIPS for PVC profiles.
See page 154 for more information.

U:	8 mm = 5/16"	9 mm = 11/32"	11 mm = 7/16"	13 mm = 33/64"	15 mm = 9/16"
O:	7 mm = 9/32"	8 mm = 5/16"	10 mm = 3/8"	12 mm = 1/2"	14 mm = 17/32"



Schluter®-DILEX-HKW

Schluter®-DILEX-HKW is a PVC cove-shaped profile for inside wall corners and floor/wall transitions in applications where limited movement is expected. The profile provides an 11/16" (18 mm) radius to prevent the accumulation of dirt and makes cleaning simple. DILEX-HKW accommodates wall and floor tiles that are of the same thickness. DILEX-HKW prevents surface water penetration and meets the maintenance and hygienic requirements of commercial kitchens, bathrooms, food processing plants, or any tiled environment where a sanitary cove base is desired.

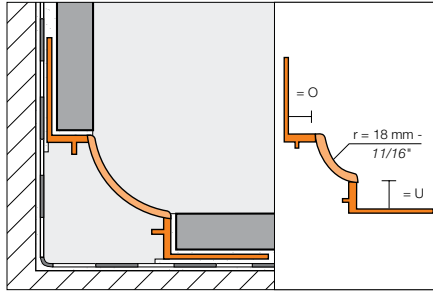

Outside corner (90°)



Inside corner, 3-way (90°)



Inside corner, 2-way (90°)



End cap

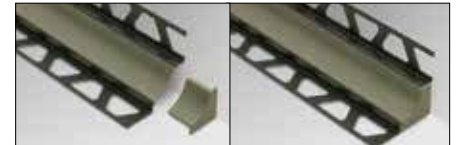

***Color Codes**



* To complete the item number, add the color code (e.g., HKW U 9 / O 9 **HB**).

U: 7 mm = 9/32" 9 mm = 11/32" 11 mm = 7/16"
O: 7 mm = 9/32" 9 mm = 11/32" 11 mm = 7/16"

Schluter®-DILEX-HKW						
Length = 2.5 m - 8' 2-1/2" U = floor or wall, O = wall		Cove base profile				
Profile	\$ / Length	Outside corner, 90°	Inside corner, 90° (2-way)	Inside corner, 90° (3-way)	End cap	\$ / Unit
HKW U 7/O 7 + color*	25.66					
HKW U 9/O 9 + color*	25.66	A/HKW/+ color*	I/HKW 2 R18/+ color*	I/HKW 3 R18/+ color*	E/HKW/G (Grey only)	4.98
HKW U 11/O 11 + color*	25.66					

Schluter®-DILEX-HK

Schluter®-DILEX-HK is a cove-shaped profile with rigid PVC anchoring legs and a soft CPE movement zone that separates individual tile fields at floor/wall transitions and forms the visible surface. The profile provides an 11/16" (18 mm) radius to prevent the accumulation of dirt and makes cleaning simple. DILEX-HK accommodates wall and floor tiles of dissimilar thicknesses and features a tile pocket that hides cut tile edges. DILEX-HKW (page 75) integrates with DILEX-HK where cove trim is required for inside wall corners. DILEX-HK prevents surface water penetration and meets the maintenance and hygienic requirements of commercial kitchens, bathrooms, food processing plants, or any tiled environment where a sanitary cove base is desired. DILEX-HK also prevents sound bridges, making it ideal for floor/wall transitions in sound-rated floors.

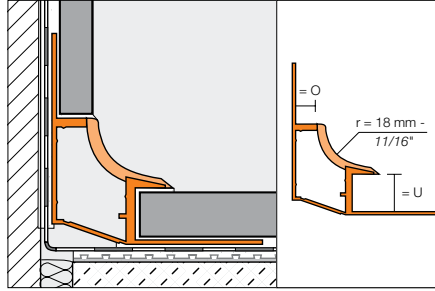

Outside corner (90°)



Connector



Inside corner, 2-way (90°)



End cap (right or left)

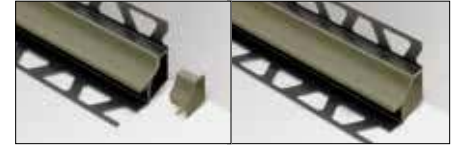

Inside corner, 3-way (90°)



Note: 3-way corners are to be used with DILEX-HKW (page 75) on the vertical.

***Color Codes**



* To complete the item number, add the **color** code (e.g., HK U 12 / O 9 **BW**).

U: 12 mm = 1/2"
O: 9 mm = 11/32"

Schluter®-DILEX-HK

Length = 2.5 m - 8' 2-1/2"		Cove base profile			
U = floor or wall, O = wall					
Profile	\$ / Length	Outside corner, 90°	Inside corner, 90° (2-way)	Inside corner, 90° (3-way)	\$ / Unit
HK U 12/O 9 + color *	38.29	A/HK/+ color *	I/HK 2 R18/+ color *	I/HK 3 R18/+ color *	4.98
Connector		V/HK			2.16
End cap (Left)		EL/HK/G (Grey only)			4.98
End cap (Right)		ER/HK/G (Grey only)			4.98



Schluter®-DILEX-AHK

Schluter®-DILEX-AHK is a cove-shaped profile with a single trapezoid-perforated anchoring leg for inside wall corners, countertop/backsplash transitions in applications where limited movement is expected. DILEX-AHK provides a 3/8" (10 mm) radius to prevent accumulation of dirt and makes cleaning simple. DILEX-AHK is available in anodized aluminum and textured color-coated aluminum. DILEX-AHK prevents surface water penetration and meets the maintenance and hygienic requirements of commercial kitchens, bathrooms, food processing plants, or any tiled environment where a sanitary cove base is desired.

Note: 90° outside corners are available in 2 configurations. The "round" corner (E90/) features a rounded front that integrates with RONDEC, while the "square" corner (E90Q/) features a square shaped front that integrates with QUADDEC.

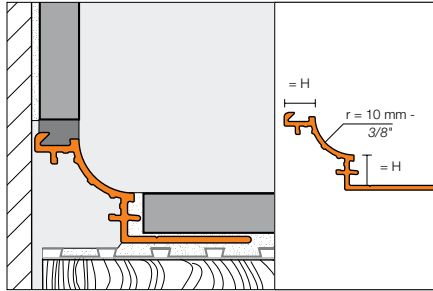

Outside corner, round (90° or 135°)



Inside corner (90° or 135°)

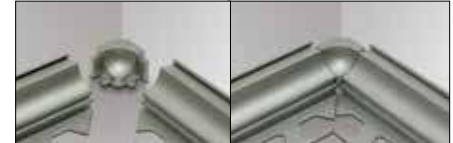

90° inside corners can be used 2-way or 3-way.

Outside corner, square (90°)

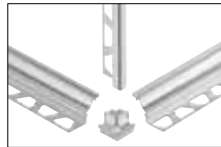

Connector



End cap



Schluter®-DILEX-AHK							
Length = 2.5 m - 8' 2-1/2"		Satin anodized aluminum (AE)					
H = mm - in.	Profile	\$/ Length	Outside corner, 90°	Outside corner, 135°	Inside corner, 90°	Inside corner, 135°	\$/ Unit
8 - 5/16	AHK 1S 80 AE	27.74	E 90/AHK 1S/AE	E 135/AHK 1S/AE	I 90/AHK 1S/AE	I 135/AHK 1S/AE	24.33
10 - 3/8	AHK 1S 100 AE	28.91					
12.5 - 1/2	AHK 1S 125 AE	30.24					
Outside corner square, 90°	E90 Q/AHK 1S/AE						22.11
Connector	V/AHK						4.13
End cap	E/AHK 1S/AE						14.58

Length = 2.5 m - 8' 2-1/2"		Polished chrome anod. alu. (ACG)					
H = mm - in.	Profile	\$/ Length	Outside corner, 90°	Outside corner, 135°	Inside corner, 90°	Inside corner, 135°	\$/ Unit
8 - 5/16	AHK 1S 80 ACG	57.29	E 90/AHK 1S/ACG	E 135/AHK 1S/ACG	I 90/AHK 1S/ACG	I 135/AHK 1S/ACG	28.05
10 - 3/8	AHK 1S 100 ACG	58.44					
12.5 - 1/2	AHK 1S 125 ACG	59.78					
Outside corner square, 90°	E90 Q/AHK 1S/ACG						25.83
Connector	V/AHK						4.13
End cap	E/AHK 1S/ACG						18.28

Length = 2.5 m - 8' 2-1/2"		Brushed chrome anod. alu. (ACGB)					
H = mm - in.	Profile	\$/ Length	Outside corner, 90°	Outside corner, 135°	Inside corner, 90°	Inside corner, 135°	\$/ Unit
8 - 5/16	AHK 1S 80 ACGB	43.05	E 90/AHK 1S/ACGB	E 135/AHK 1S/ACGB	I 90/AHK 1S/ACGB	I 135/AHK 1S/ACGB	28.05
10 - 3/8	AHK 1S 100 ACGB	44.22					
12.5 - 1/2	AHK 1S 125 ACGB	45.55					
Connector	V/AHK						4.13
End cap	E/AHK 1S/ACGB						18.28

Schluter®-DILEX-AHK							
Length = 2.5 m - 8' 2-1/2"	Satin nickel anod. alu. (AT)						
H = mm - in.	Profile	\$ / Length	Outside corner, 90°	Outside corner, 135°	Inside corner, 90°	Inside corner, 135°	\$ / Unit
8 - 5/16	AHK 1S 80 AT	32.12	E 90/AHK 1S/AT	E 135/AHK 1S/AT	I 90/AHK 1S/AT	I 135/AHK 1S/AT	24.33
10 - 3/8	AHK 1S 100 AT	33.29					
12.5 - 1/2	AHK 1S 125 AT	34.62					
15- 9/16	AHK 1S 150 AT	36.00					
Outside corner square, 90°	E90 Q/AHK 1S/AT						22.11
Connector	V/AHK						4.13
End cap	E/AHK 1S/AT						14.58

Length = 2.5 m - 8' 2-1/2"	Polished nickel anod. alu. (ATG)						
H = mm - in.	Profile	\$ / Length	Outside corner, 90°	Outside corner, 135°	Inside corner, 90°	Inside corner, 135°	\$ / Unit
8 - 5/16	AHK 1S 80 ATG	60.52	E 90/AHK 1S/ATG	E 135/AHK 1S/ATG	I 90/AHK 1S/ATG	I 135/AHK 1S/ATG	28.05
10 - 3/8	AHK 1S 100 ATG	61.68					
12.5 - 1/2	AHK 1S 125 ATG	63.02					
Connector	V/AHK						
End cap	E/AHK 1S/ATG						18.28

Length = 2.5 m - 8' 2-1/2"	Brushed nickel anod. alu. (ATGB)						
H = mm - in.	Profile	\$ / Length	Outside corner, 90°	Outside corner, 135°	Inside corner, 90°	Inside corner, 135°	\$ / Unit
8 - 5/16	AHK 1S 80 ATGB	46.29	E 90/AHK 1S/ATGB	E 135/AHK 1S/ATGB	I 90/AHK 1S/ATGB	I 135/AHK 1S/ATGB	28.05
10 - 3/8	AHK 1S 100 ATGB	47.46					
12.5 - 1/2	AHK 1S 125 ATGB	48.78					
Connector	V/AHK						
End cap	E/AHK 1S/ATGB						18.28

Length = 2.5 m - 8' 2-1/2"	Satin copper anod. alu. (AK)						
H = mm - in.	Profile	\$ / Length	Outside corner, 90°	Outside corner, 135°	Inside corner, 90°	Inside corner, 135°	\$ / Unit
8 - 5/16	AHK 1S 80 AK	32.12	E 90/AHK 1S/AK	E 135/AHK 1S/AK	I 90/AHK 1S/AK	I 135/AHK 1S/AK	24.33
10 - 3/8	AHK 1S 100 AK	33.29					
12.5 - 1/2	AHK 1S 125 AK	34.62					
Connector	V/AHK						
End cap	E/AHK 1S/AK						14.58

Length = 2.5 m - 8' 2-1/2"	Polished copper anod. alu. (AKG)						
H = mm - in.	Profile	\$ / Length	Outside corner, 90°	Outside corner, 135°	Inside corner, 90°	Inside corner, 135°	\$ / Unit
8 - 5/16	AHK 1S 80 AKG	60.52	E 90/AHK 1S/AKG	E 135/AHK 1S/AKG	I 90/AHK 1S/AKG	I 135/AHK 1S/AKG	28.05
10 - 3/8	AHK 1S 100 AKG	61.68					
12.5 - 1/2	AHK 1S 125 AKG	63.02					
Connector	V/AHK						
End cap	E/AHK 1S/AKG						18.28

Length = 2.5 m - 8' 2-1/2"	Brushed copper anod. alu. (AKGB)						
H = mm - in.	Profile	\$ / Length	Outside corner, 90°	Outside corner, 135°	Inside corner, 90°	Inside corner, 135°	\$ / Unit
8 - 5/16	AHK 1S 80 AKGB	46.29	E 90/AHK 1S/AKGB	E 135/AHK 1S/AKGB	I 90/AHK 1S/AKGB	I 135/AHK 1S/AKGB	28.05
10 - 3/8	AHK 1S 100 AKGB	47.46					
12.5 - 1/2	AHK 1S 125 AKGB	48.78					
Connector	V/AHK						
End cap	E/AHK 1S/AKGB						18.28



Schluter®-DILEX-AHK							
Length = 2.5 m - 8' 2-1/2"		Satin brass anod. alu. (AM)					
H = mm - in.	Profile	\$/ Length	Outside corner, 90°	Outside corner, 135°	Inside corner, 90°	Inside corner, 135°	\$/ Unit
8 - 5/16	AHK 1S 80 AM	32.12	E 90/AHK 1S/AM	E 135/AHK 1S/AM	I 90/AHK 1S/AM	I 135/AHK 1S/AM	24.33
10 - 3/8	AHK 1S 100 AM	33.29					
12.5 - 1/2	AHK 1S 125 AM	34.62					
Connector	V/AHK						4.13
End cap	E/AHK 1S/AM						14.58

Schluter®-DILEX-AMG							
Length = 2.5 m - 8' 2-1/2"		Polished brass anod. alu. (AMG)					
H = mm - in.	Profile	\$/ Length	Outside corner, 90°	Outside corner, 135°	Inside corner, 90°	Inside corner, 135°	\$/ Unit
8 - 5/16	AHK 1S 80 AMG	58.96	E 90/AHK 1S/AMG	E 135/AHK 1S/AMG	I 90/AHK 1S/AMG	I 135/AHK 1S/AMG	28.05
10 - 3/8	AHK 1S 100 AMG	60.11					
12.5 - 1/2	AHK 1S 125 AMG	61.46					
Connector	V/AHK						4.13
End cap	E/AHK 1S/AMG						18.28

Schluter®-DILEX-AMGB							
Length = 2.5 m - 8' 2-1/2"		Brushed brass anod. alu. (AMGB)					
H = mm - in.	Profile	\$/ Length	Outside corner, 90°	Outside corner, 135°	Inside corner, 90°	Inside corner, 135°	\$/ Unit
8 - 5/16	AHK 1S 80 AMGB	44.72	E 90/AHK 1S/AMGB	E 135/AHK 1S/AMGB	I 90/AHK 1S/AMGB	I 135/AHK 1S/AMGB	28.05
10 - 3/8	AHK 1S 100 AMGB	45.89					
12.5 - 1/2	AHK 1S 125 AMGB	47.22					
Connector	V/AHK						4.13
End cap	E/AHK 1S/AMGB						18.28

Schluter®-DILEX-AGRB							
Length = 2.5 m - 8' 2-1/2"		Brushed graphite anod. alu. (AGRB)					
H = mm - in.	Profile	\$/ Length	Outside corner, 90°	Outside corner, 135°	Inside corner, 90°	Inside corner, 135°	\$/ Unit
8 - 5/16	AHK 1S 80 AGRB	46.29	E 90/AHK 1S/AGRB	E 135/AHK 1S/AGRB	I 90/AHK 1S/AGRB	I 135/AHK 1S/AGRB	28.05
10 - 3/8	AHK 1S 100 AGRB	47.46					
12.5 - 1/2	AHK 1S 125 AGRB	48.78					
15 - 9/16	AHK 1S 150 AGRB	50.24					
Connector	V/AHK						4.13
End cap	E/AHK 1S/AGRB						18.28

Schluter®-TRENDLINE Textured Color-coated Aluminum

Schluter®-TRENDLINE Textured Color-coated Aluminum (TS)							
Length = 2.5 m - 8' 2-1/2"		Textured color-coated aluminum (TS)					
H = mm - in.	Profile	\$/ Length	Outside corner, 90°	Outside corner, 135°	Inside corner, 90°	Inside corner, 135°	\$/ Unit
8 - 5/16	AHK 1S 80 + color*	50.12	E 90/AHK 1S/ + color*	E 135/AHK 1S/ + color*	I 90/AHK 1S/ + color*	I 135/AHK 1S/ + color*	30.37
10 - 3/8	AHK 1S 100 + color*	50.84					
12.5 - 1/2	AHK 1S 125 + color*	51.92					
15 - 9/16	AHK 1S 150 + color*	52.96					
Outside corner square, 90°	E90 Q/AHK 1S/+ color*						25.63
Connector	V/AHK						4.13
End cap	E/AHK 1S/+ color*						20.11

*Color Codes



* To complete the item number, add the color code (e.g., AHK 1S 80 TSB).

Schluter®-DILEX-AHKA

Schluter®-DILEX-AHKA is a cove-shaped profile for transitions between walls to be tiled and previously finished floors. DILEX-AHKA is available in anodized aluminum and textured color-coated aluminum. The profile features a single-trapezoid perforated anchoring leg that is secured in the mortar bond coat and a dovetailed channel, which can be bonded to floor surfaces using Schluter®-KERDI-FIX, epoxy resin, silicone, thin-set mortar, etc. A 3/8" (10 mm) radius cove section forms the visible surface and prevents the accumulation of dirt, making cleaning simple. DILEX-AHKA prevents surface water penetration and meets the maintenance and hygienic requirements of commercial kitchens, bathrooms, food processing plants, or any tiled environment where a sanitary cove base is desired. DILEX-AHKA integrates with the Schluter®-DILEX-AHK and Schluter®-RONDEC profiles at 90° inside and outside vertical wall corners, respectively.

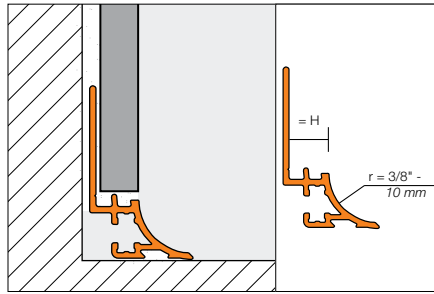

Outside corner (90° or 135°)

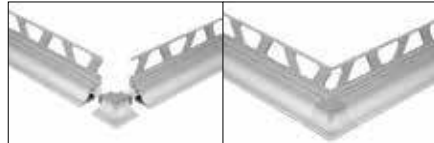

Inside corner (90° or 135°)

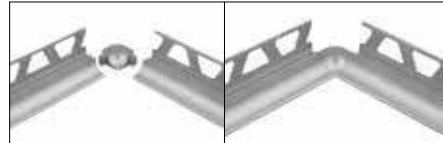

End cap



90° inside corners can be used 2-way, or 3-way when combined with DILEX-AHK on the vertical inside corner.

Schluter®-DILEX-AHKA							
Length = 2.5 m - 8' 2-1/2"	Satin anodized aluminum (AE)						
H = mm - in.	Profile	\$ / Length	Outside corner, 90°	Outside corner, 135°	Inside corner, 90°	Inside corner, 135°	\$ / Unit
8 - 5/16	AHKA 80 AE	27.74	E 90/AHKA/AE	E 135/AHKA/AE	I 90/AHKA/AE	I 135/AHKA/AE	24.33
10 - 3/8	AHKA 100 AE	28.91					
12.5 - 1/2	AHKA 125 AE	30.24					
15 - 9/16	AHKA 150 AE	31.45					
End cap (left)	EL/AHKA/AE						14.58
End cap (right)	ER/AHKA/AE						14.58

Schluter®-DILEX-AHKA							
Length = 2.5 m - 8' 2-1/2"	Brushed chrome anod. alu. (ACGB)						
H = mm - in.	Profile	\$ / Length	Outside corner, 90°	Outside corner, 135°	Inside corner, 90°	Inside corner, 135°	\$ / Unit
8 - 5/16	AHKA 80 ACGB	43.05	E 90/AHKA/ACGB	E 135/AHKA/ACGB	I 90/AHKA/ACGB	I 135/AHKA/ACGB	28.05
10 - 3/8	AHKA 100 ACGB	44.22					
12.5 - 1/2	AHKA 125 ACGB	45.55					
15 - 9/16	AHKA 150 ACGB	47.38					
End cap (left)	EL/AHKA/ACGB						18.28
End cap (right)	ER/AHKA/ACGB						18.28

Schluter®-DILEX-AHKA							
Length = 2.5 m - 8' 2-1/2"	Satin nickel anod. alu. (AT)						
H = mm - in.	Profile	\$ / Length	Outside corner, 90°	Outside corner, 135°	Inside corner, 90°	Inside corner, 135°	\$ / Unit
8 - 5/16	AHKA 80 AT	32.12	E 90/AHKA/AT	E 135/AHKA/AT	I 90/AHKA/AT	I 135/AHKA/AT	24.33
10 - 3/8	AHKA 100 AT	33.29					
12.5 - 1/2	AHKA 125 AT	34.62					
15 - 9/16	AHKA 150 AT	36.00					
End cap (left)	EL/AHKA/AT						14.58
End cap (right)	ER/AHKA/AT						14.58



Schluter®-DILEX-AHKA							
Length = 2.5 m - 8' 2-1/2"	Brushed nickel anod. alu. (ATGB)						
H = mm - in.	Profile	\$/ Length	Outside corner, 90°	Outside corner, 135°	Inside corner, 90°	Inside corner, 135°	\$/ Unit
8 - 5/16	AHKA 80 ATGB	46.29	E 90/AHKA/ATGB	E 135/AHKA/ATGB	I 90/AHKA/ATGB	I 135/AHKA/ATGB	28.05
10 - 3/8	AHKA 100 ATGB	47.46					
12.5 - 1/2	AHKA 125 ATGB	48.78					
15 - 9/16	AHKA 150 ATGB	50.24					
End cap (left)	EL/AHKA/ATGB						18.28
End cap (right)	ER/AHKA/ATGB						18.28

Schluter®-TRENDLINE Textured Color-coated Aluminum

Length = 2.5 m - 8' 2-1/2"	Textured color-coated aluminum (TS)						
H = mm - in.	Profile	\$/ Length	Outside corner, 90°	Outside corner, 135°	Inside corner, 90°	Inside corner, 135°	\$/ Unit
8 - 5/16	AHKA 80 + color*	50.12	E 90/AHKA/ + color*	E 135/AHKA/ + color*	I 90/AHKA/ + color*	I 135/AHKA/ + color*	30.37
10 - 3/8	AHKA 100 + color*	50.84					
12.5 - 1/2	AHKA 125 + color*	51.92					
15 - 9/16	AHKA 150 + color*	52.96					
End cap (left)	EL/AHKA/+ color*						19.59
End cap (right)	ER/AHKA/+ color*						19.59

***Color Codes**

 TSR Rustic brown	 TSDA Dark anthracite	 TSLA Light anthracite	 TSSG Stone grey	 TSC Cream	 TSBG Greige	 TSI Ivory	 TSB Beige	 TSOB Bronze	 TSG Pewter
--	--	---	---	---	---	---	---	---	--

* To complete the item number, add the color code (e.g., AHKA 80 **TSB**).

Schluter®-DILEX-PHK

Schluter®-DILEX-PHK is a PVC, cove-shaped profile for inside wall corners, countertop/backsplash transitions and floor/wall transitions in applications where limited movement is expected. DILEX-PHK provides a 3/8" (10 mm) radius to prevent the accumulation of dirt and makes cleaning simple. DILEX-PHK prevents surface water penetration and meets the maintenance and hygienic requirements of commercial kitchens, bathrooms, food processing plants, or any tiled environment where a sanitary cove base is desired.

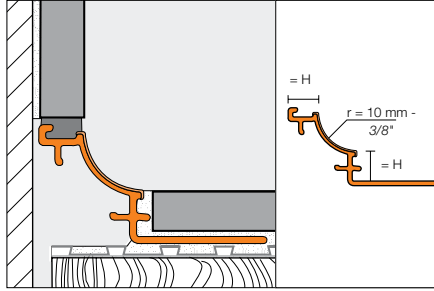

Outside corner (90° or 135°)

Inside corner (90° or 135°)

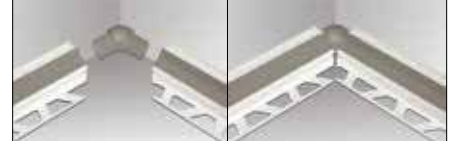

Connector

End cap



90° inside corners can be used 2-way or 3-way.

***Color Codes**

-  **BW** Bright white
-  **W** White
-  **SP** Sand pebble
-  **BH** Bahama
-  **HB** Light beige
-  **PG** Classic grey
-  **G** Grey

* To complete the item number, add the color code (e.g., PHK 1S 80 / **BW**).

Schluter®-DILEX-PHK

Length = 2.5 m - 8' 2-1/2"		Cove base profile					
H = mm - in.	Profile	\$ / Length	Outside corner, 90°	Outside corner, 135°	Inside corner, 90°	Inside corner, 135°	\$ / Unit
8 - 5/16	PHK 1S 80 + color*	20.15					
10 - 3/8	PHK 1S 100 + color*	21.24	E 90/PHK 1S/ + color*	E 135/PHK 1S/ + color*	I 90/PHK 1S/ + color*	I 135/PHK 1S/ + color*	2.88
12.5 - 1/2	PHK 1S 125 + color*	21.55					
Connector	V/PHK						1.61
End cap	E/PHK 1S/ + color*						2.88



Schluter®-DILEX-EHK

Schluter®-DILEX-EHK is a stainless steel, cove-shaped profile for inside wall corners, countertop/backsplash transitions and floor/wall transitions in applications where limited movement is expected. DILEX-EHK provides a 23/32" (18.5 mm) radius to prevent the accumulation of dirt and makes cleaning simple. DILEX-EHK prevents surface water penetration and meets the maintenance and hygienic requirements of commercial kitchens, bathrooms, food processing plants, or any tiled environment where a sanitary cove base is desired.

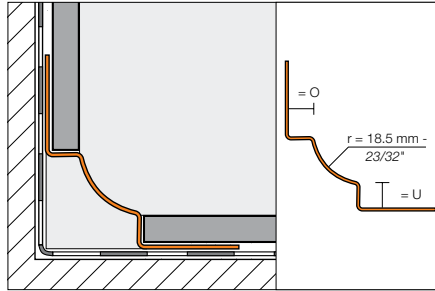

Outside corner (90° or 135°)



Inside corner, 3-way (90°)



Inside corner, 2-way (90° or 135°)



Connector

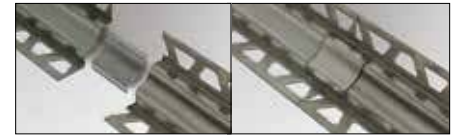
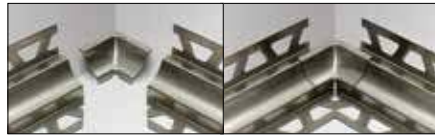

End cap

U: 7 mm = 9/32"	9 mm = 11/32"
11 mm = 7/16"	16 mm = 5/8"
O: 7 mm = 9/32"	9 mm = 11/32"
11 mm = 7/16"	16 mm = 5/8"

Schluter®-DILEX-EHK							
Length = 2.5 m - 8' 2-1/2" U = floor or wall, O = wall		Stainless steel 304 (1.4301 = V2A) (E)					
Profile	\$ / Length	Outside corner, 90°	Inside corner, 90° (2-way)	Inside corner, 90° (3-way)	Outside corner, 135°	Inside corner, 135°	\$ / Unit
EHK U 7/O 7	78.68	A/EHK 2 R18	I/EHK 2 R18	I/EHK 3 R18	E135/EHK2R18	I135/EHK2R18	9.48
EHK U 9/O 9	80.91						
EHK U 11/O 11	83.53						
Connector		V/EHK					9.48
End cap		E/HKW/G (Grey PVC only)					4.98

Stainless steel 316 L (1.4404 = V4A) (EV4A)	
Length = 2.5 m - 8' 2-1/2" U = floor or wall, O = wall	
Profile	\$ / Length
EHK U 7/O 7/V4A	86.55
EHK U 9/O 9/V4A	89.02
EHK U 11/O 11/V4A	91.90
EHK U 16/O 16/V4A	101.08

Brushed stainless steel 304 (1.4301 = V2A) (EB)							
Length = 2.5 m - 8' 2-1/2" U = floor or wall, O = wall		Brushed stainless steel 304 (1.4301 = V2A) (EB)					
Profile	\$ / Length	Outside corner, 90°	Inside corner, 90° (2-way)	Inside corner, 90° (3-way)	Outside corner, 135°	Inside corner, 135°	\$ / Unit
EBHK U 7/O 7	102.30	A/EBHK 2 R18	I/EBHK 2 R18	I/EBHK 3 R18	E135/EBHK2R18	I135/EBHK2R18	12.36
EBHK U 9/O 9	105.41						
EBHK U 11/O 11	108.81						
Connector		V/EBHK					12.36
End cap		E/HKW/G (Grey PVC only)					4.98

Schluter®-DILEX-HKS

Schluter®-DILEX-HKS is a stainless steel, cove-shaped profile for inside wall corners, and floor/wall transitions in applications. DILEX-HKS features a soft, thermoplastic rubber movement zone to absorb larger movements at floor/wall transitions and inside wall corners and a 23/32" (18.5 mm) radius to prevent the accumulation of dirt and makes cleaning simple. DILEX-HKS prevents surface water penetration and meets the maintenance and hygienic requirements of commercial kitchens, bathrooms, food processing plants, or any tiled environment where a sanitary cove base is desired.

Note: DILEX-HKS is also available in stainless steel 316L (1.4404 = V4A). Contact Customer Service for price and availability.

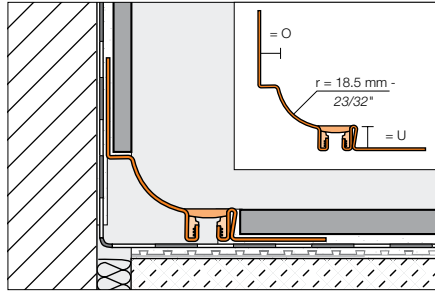

Outside corner (90°)



Inside corner, 2-way (90°)



Inside corner, 3-way (90°)



Connector

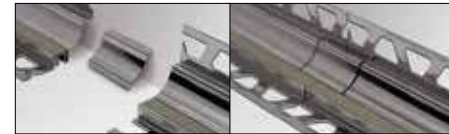
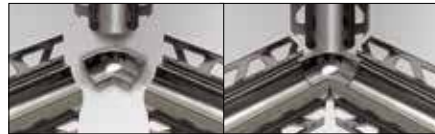

End cap

Note: 3-way corners are to be used with DILEX-EHK (page 83) on the vertical.

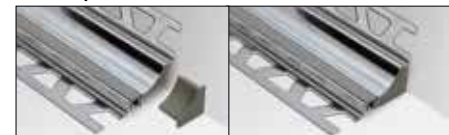

***Color Codes**



* To complete the item number, add the color code (e.g., HKS V2A U 18 / O 7 **G**).

U: 8 mm = 5/16"	10 mm = 3/8"	12 mm = 15/32"	14 mm = 17/32"	16 mm = 5/8"
18 mm = 23/32"	21 mm = 13/16"	25 mm = 1"	30 mm = 1-3/16"	
O: 7 mm = 9/32"	9 mm = 11/32"	11 mm = 7/16"		

Schluter®-DILEX-HKS	
Length = 2.5 m - 8' 2-1/2" U = floor or wall, O = wall	Stainless steel 304 (1.4301 = V2A) (E)
Profile	\$ / Length
HKS V2A U 8 / O 7 + color*	142.42
HKS V2A U 10 / O 7 + color*	143.83
HKS V2A U 12 / O 7 + color*	145.91
HKS V2A U 14 / O 7 + color*	146.62
HKS V2A U 16 / O 7 + color*	148.02
HKS V2A U 18 / O 7 + color*	148.72
HKS V2A U 21 / O 7 + color*	150.11
HKS V2A U 25 / O 7 + color*	152.90
HKS V2A U 30 / O 7 + color*	154.99
HKS V2A U 8 / O 9 + color*	142.42
HKS V2A U 10 / O 9 + color*	143.83
HKS V2A U 12 / O 9 + color*	145.91
HKS V2A U 14 / O 9 + color*	146.62
HKS V2A U 16 / O 9 + color*	148.02
HKS V2A U 18 / O 9 + color*	148.72
HKS V2A U 21 / O 9 + color*	150.11
HKS V2A U 25 / O 9 + color*	152.90
HKS V2A U 30 / O 9 + color*	154.99
HKS V2A U 8 / O 11 + color*	142.42
HKS V2A U 10 / O 11 + color*	143.83
HKS V2A U 12 / O 11 + color*	145.91
HKS V2A U 14 / O 11 + color*	146.62
HKS V2A U 16 / O 11 + color*	148.02
HKS V2A U 18 / O 11 + color*	148.72
HKS V2A U 21 / O 11 + color*	150.11
HKS V2A U 25 / O 11 + color*	152.90
HKS V2A U 30 / O 11 + color*	154.99

Schluter®-DILEX-HKS		
Stainless steel 304 (1.4301 = V2A) (E)		\$ / Unit
Outside corner, 90°	A/EHK 2 R18	9.48
Inside corner, 90° (2-way)	I/EHK 2 R18	9.48
Inside corner, 90° (3-way)	I/EHK 3 R18	9.48
Outside corner, 135°	E135/EHK2R18	9.48
Inside corner, 135°	I135/EHK2R18	9.48
Connector	V/EHK	9.48
End cap	E/HKW/G (Grey PVC only)	4.98

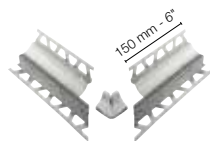

Note: 90° outside corners with pre-cut profile sections are available by special order only. Please contact Customer Service for availability.

Schluter®-DILEX-HKS		
Stainless steel 304 (1.4301 = V2A) (E)		\$ / Unit
90° outside corner with pre-cut profile sections	E90 V2A U ... / O ... + color**	50.52
Stainless steel 316L (1.4404 = V4A) (E)		\$ / Unit
90° outside corner with pre-cut profile sections	E90 V4A U ... / O ... + color**	56.13

** To complete the item number, add the "U" and "O" values, and the color code (e.g., E90 V2A U 12 / O 9 G). Available for U = 8, 10, 12, 14 and 16 mm only.



Schluter®-DILEX-HKU

Schluter®-DILEX-HKU is a stainless steel, cove-shaped profile for inside wall corners and floor/wall (including countertop/backsplash) transitions. DILEX-HKU may be used with floor coverings other than ceramic and stone tile, provided the floor coverings are fastened or adhered (i.e., no floating floors). The profile features a single anchoring leg that turns inward, which allows it to be used with different thicknesses of tile. DILEX-HKU is available with either a 3/8" (10 mm) or 1-7/16" (36 mm) radius cove section. The cove section forms the visible surface and prevents the accumulation of dirt, making cleaning simple. DILEX-HKU prevents surface water penetration and meets the maintenance and hygienic requirements of commercial kitchens, bathrooms, and food processing plants, or any tiled environment where a sanitary cove base is desired.

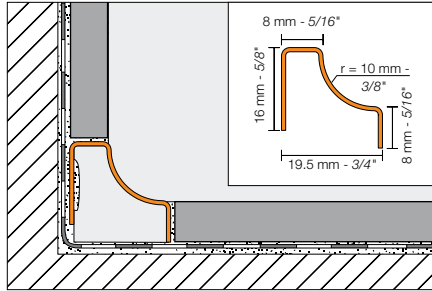

Outside corner (90° or 135°)

Inside corner (90° or 135°)

Connector



Note: DILEX-HKU outside and inside corners are made of stainless steel, 316 L (1.4404 = V4A).

Schluter®-DILEX-HKU (10 mm - 3/8" radius)								
Length = 2.5 m - 8' 2-1/2"	Stainless steel 304 (1.4301 = V2A) (E)							
R = mm - in.	Profile	\$/ Length	Outside corner 90°	Inside corner 90°	\$/ Unit	Outside corner 135°	Inside corner 135°	\$/ Unit
10 - 3/8	HKUR 10 E	46.82	EQ/HKUR 10 E	I/HKU 3 R 10 E	5.32	E135/HKUR 10 E	I135/HKUR 10 E	5.08
Connector	V/HKUR 10 E							4.83
End cap	EK/HKUR 10 E							4.57

Length = 2.5 m - 8' 2-1/2"	Stainless steel 316L (1.4404 = V4A) (E)							
R = mm - in.	Profile	\$/ Length	Outside corner 90°	Inside corner 90°	\$/ Unit	Outside corner 135°	Inside corner 135°	\$/ Unit
10 - 3/8	HKUR 10 E / V4A	70.19	EQ/HKUR 10 E	I/HKU 3 R 10 E	5.32	E135/HKUR 10 E	I135/HKUR 10 E	5.08
Connector	V/HKUR 10 E							4.83
End cap	EK/HKUR 10 E							4.57

Length = 2.5 m - 8' 2-1/2"	Brushed stainless steel 304 (1.4301 = V2A) (EB)							
R = mm - in.	Profile	\$/ Length	Outside corner 90°	Inside corner 90°	\$/ Unit	Outside corner 135°	Inside corner 135°	\$/ Unit
10 - 3/8	HKUR 10 EB	51.27	EQ/HKUR 10 EB	I/HKU 3 R 10 EB	5.32	E135/HKUR 10 EB	I135/HKUR 10 EB	5.08
Connector	V/HKUR 10 EB							4.83
End cap	EK/HKUR 10 EB							4.57

Schluter®-DILEX-HKU (36 mm - 1-7/16" radius)					
Length = 2.5 m - 8' 2-1/2"	Stainless steel 304 (1.4301 = V2A) (E)				
R = mm - in.	Profile	\$/ Length	Outside corner 90°	Inside corner 90°*	\$/ Unit
36 - 1-7/16	HKUR 36 E	79.94	E/HKUR 36 E	I/HKU 3 R 36 10 E	9.70
External connector, stainless steel	V/HKUR 36 E				9.70
Internal connector, EPS foam	VI/HKUR 36				2.75
End cap	EK/HKUR 36 E (grey PVC only)				7.31

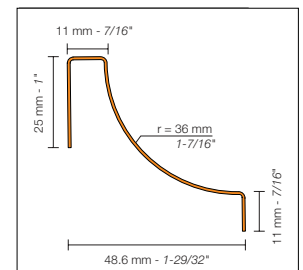

*For 3-way inside corners, use the Schluter®-DILEX-EHK profile on the vertical (page 83).

Internal connector, EPS foam

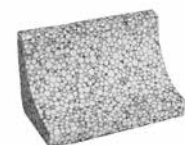



Schluter®-VINPRO

NEW!

FINISHING, EDGE-PROTECTION, & TRANSITION PROFILES FOR RESILIENT FLOOR AND WALL COVERINGS

Luxury vinyl and other resilient flooring materials have improved and evolved into a new generation of vinyl floor coverings. Mimicking the natural looks of wood and stone using high-fidelity printing, the product is durable and realistic in both finish and texture. Updating existing applications to follow the latest trends in color and style are simplified with luxury vinyl's broad range of customization options for design and layout. Schluter®-Systems offers a variety of finishing, transition, and edge-protection profiles for resilient floor and wall coverings to increase design flexibility and provide long-lasting finishes.





Schluter®-VINPRO-S

Schluter®-VINPRO-S is designed to provide edging for resilient coverings (e.g., LVT). Typical applications include edge protection where the resilient covering is bordered by carpet, floor coverings of similar heights, or as a finishing edge to wall skirting applications.

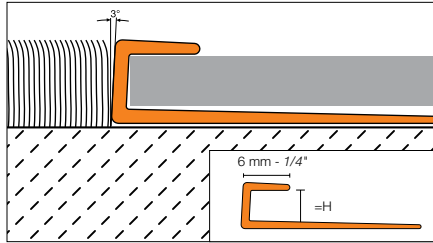

Schluter®-VINPRO-S						
Length = 2.5 m - 8' 2-1/2"	Brushed chrome anod. alu. (ACGB)		Brushed nickel anod. alu. (ATGB)		Brushed antique bronze anod. alu. (ABGB)	
H = mm - in.	Item No.	\$/ Length	Item No.	\$/ Length	Item No.	\$/ Length
3 - 1/8	VPS 30 ACGB	17.94	VPS 30 ATGB	19.05	VPS 30 ABGB	20.08
4 - 5/32	VPS 40 ACGB	18.05	VPS 40 ATGB	19.26	VPS 40 ABGB	20.32
5 - 3/16	VPS 50 ACGB	18.20	VPS 50 ATGB	19.41	VPS 50 ABGB	20.56
6 - 1/4	VPS 60 ACGB	18.47	VPS 60 ATGB	19.73	VPS 60 ABGB	20.67

Schluter®-VINPRO-T

Schluter®-VINPRO-T is designed to provide transitions between same-height resilient floor coverings, (e.g., LVT) primarily in retrofit applications.

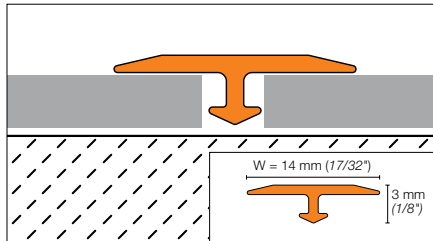

Schluter®-VINPRO-T						
Length = 2.5 m - 8' 2-1/2"	Brushed chrome anod. alu. (ACGB)		Brushed nickel anod. alu. (ATGB)		Brushed antique bronze anod. alu. (ABGB)	
W = mm - in.	Item No.	\$/ Length	Item No.	\$/ Length	Item No.	\$/ Length
14 - 17/32	VPT 3/14 ACGB	14.00	VPT 3/14 ATGB	14.00	VPT 3/14 ABGB	14.00

Schluter®-VINPRO-STEP

Schluter®-VINPRO-STEP is a finishing and edging profile for resilient covering (e.g., LVT) installations on stairs. The top of the profile features a square design and a capping flange that is ribbed to provide slip protection.

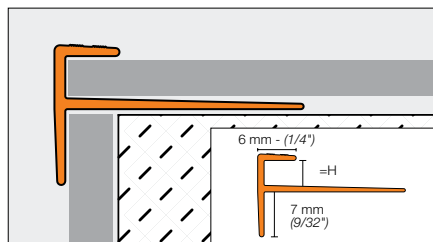

Schluter®-VINPRO-STEP						
Length = 2.5 m - 8' 2-1/2"	Brushed chrome anod. alu. (ACGB)		Brushed nickel anod. alu. (ATGB)		Brushed antique bronze anod. alu. (ABGB)	
H = mm - in.	Item No.	\$/ Length	Item No.	\$/ Length	Item No.	\$/ Length
3 - 1/8	VPST 30 ACGB	23.00	VPST 30 ATGB	24.00	VPST 30 ABGB	24.00
4 - 5/32	VPST 40 ACGB	23.50	VPST 40 ATGB	24.50	VPST 40 ABGB	24.50
5 - 3/16	VPST 50 ACGB	24.00	VPST 50 ATGB	25.00	VPST 50 ABGB	25.00
6 - 1/4	VPST 60 ACGB	24.50	VPST 60 ATGB	25.50	VPST 60 ABGB	25.50



Schluter®-VINPRO-U

Schluter®-VINPRO-U is designed to provide a smooth transition between resilient floor coverings (e.g., LVT) and floor coverings at lower elevations or finished concrete. The sloped surface eliminates trip hazards.

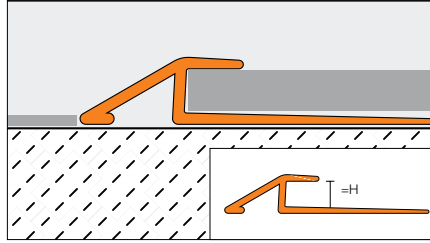
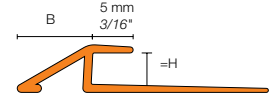

Diagram Values



H = mm - in.	B = mm - in.
3 - 1/8	8 - 5/16
4 - 5/32	9.5 - 3/8
5 - 3/16	11.5 - 29/64
6 - 1/4	13 - 33/64

Schluter®-VINPRO-U						
Length = 2.5 m - 8' 2-1/2"	Brushed chrome anod. alu. (ACGB)		Brushed nickel anod. alu. (ATGB)		Brushed antique bronze anod. alu. (ABGB)	
H = mm - in.	Item No.	\$ / Length	Item No.	\$ / Length	Item No.	\$ / Length
3 - 1/8	VPU 30 ACGB	21.00	VPU 30 ATGB	23.00	VPU 30 ABGB	23.00
4 - 5/32	VPU 40 ACGB	21.50	VPU 40 ATGB	23.50	VPU 40 ABGB	23.50
5 - 3/16	VPU 50 ACGB	22.00	VPU 50 ATGB	24.00	VPU 50 ABGB	24.00
6 - 1/4	VPU 60 ACGB	22.50	VPU 60 ATGB	24.50	VPU 60 ABGB	24.50

Schluter®-VINPRO-RO

Schluter®-VINPRO-RO is a finishing and edging profile for resilient covering (e.g., LVT) installations on stairs and outside corners of resilient surfaces. The reveal of the profile forms a symmetrically rounded corner along the surface edge.

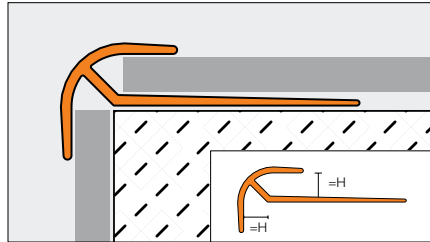

Schluter®-VINPRO-RO						
Length = 2.5 m - 8' 2-1/2"	Brushed chrome anod. alu. (ACGB)		Brushed nickel anod. alu. (ATGB)		Brushed antique bronze anod. alu. (ABGB)	
H = mm - in.	Item No.	\$ / Length	Item No.	\$ / Length	Item No.	\$ / Length
3 - 1/8	VPRO 30 ACGB	23.00	VPRO 30 ATGB	24.00	VPRO 30 ABGB	24.00
4 - 5/32	VPRO 40 ACGB	23.50	VPRO 40 ATGB	24.50	VPRO 40 ABGB	24.50
5 - 3/16	VPRO 50 ACGB	24.00	VPRO 50 ATGB	25.00	VPRO 50 ABGB	25.00
6 - 1/4	VPRO 60 ACGB	24.50	VPRO 60 ATGB	25.50	VPRO 60 ABGB	25.50



Schluter®-KERDI-BOARD

SUBSTRATE, BUILDING PANEL, BONDED WATERPROOFING

Whether you work with mosaics or large-format tiles, an absolutely flat substrate with straight and precisely aligned inside and outside corners is essential for creating a perfect tile covering, which tile installers can now achieve on their own using KERDI-BOARD.

KERDI-BOARD gives tile setters control over their projects by providing them with the means to simply and easily create ideal substrates for tile. Unsuitable substrates can be remedied and new substrates can be produced while keeping the technical and aesthetic requirements of the tile covering in mind.

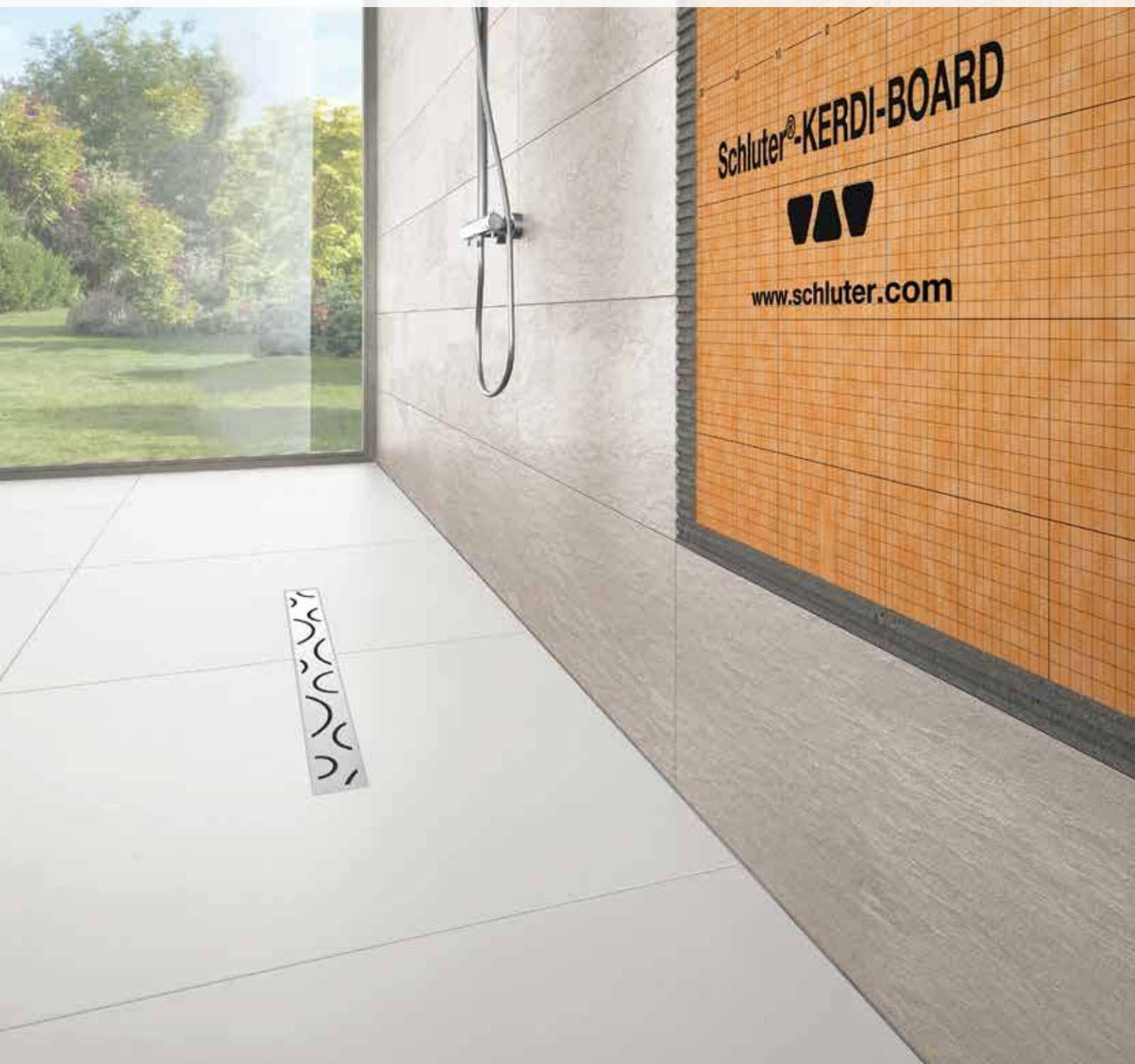



Schluter®-KERDI-BOARD

Schluter®-KERDI-BOARD is a multifunctional tile substrate and building panel, which can also be used for creating bonded waterproofing assemblies with tile coverings. It consists of an extruded polystyrene foam panel, with a special reinforcement material on both sides and fleece webbing for effective anchoring in thin-set mortar.

With the available panel thicknesses of 3/16", 3/8", 1/2", 5/8", 3/4", 1", 1-1/2", and 2" (5, 9, 12.5, 15, 19, 25, 38, and 50 mm), KERDI-BOARD allows the installer to prepare and create a broad range of substrates and building elements for the installation of ceramic and natural stone tile that are flat, level, plumb, square, and dimensionally stable. With suitable preparation of the abutting seams and joint areas, the panel may be used for bonded waterproofing assemblies.

The boards are simply cut to size with a utility knife. The gridlines, which are printed on the surface, are helpful for neat and quick cuts and installation. Tiles can be installed directly over KERDI-BOARD using the thin-set method.



KERDI-BOARD panels are shipped in bundles only. Please order in multiples of the bundle quantity.

Bundles are packaged using protective endcaps to prevent damage. Additional protective endcaps are included on each pallet to allow for repackaging of bundles as needed.

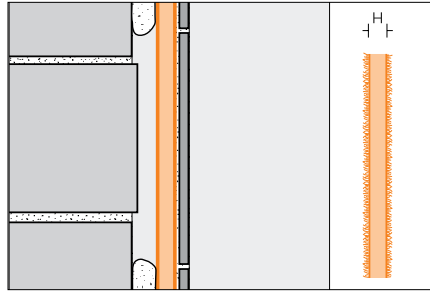

Schluter®-KERDI-BOARD				
Substrate and building panel				
H = mm - in.	Item No.	\$ / Panel	Panels / Bundle	\$ / Bundle
Panel dimension: 122 cm x 81 cm – 48" x 32"				
12.5 - 1/2	KB 12 1220 812	36.90	18	664.20
Panel dimension: 122 cm x 162.5 cm – 48" x 64"				
5 - 3/16	KB 5 1220 1625	67.24	10	672.40
9 - 3/8	KB 9 1220 1625	70.53	8	564.24
12.5 - 1/2	KB 12 1220 1625	73.82	6	442.92
Panel dimension: 122 cm x 244 cm – 48" x 96"				
5 - 3/16	KB 5 1220 2440	100.82	6	604.92
9 - 3/8	KB 9 1220 2440	105.77	5	528.85
12.5 - 1/2	KB 12 1220 2440	110.71	5	553.55
15 - 5/8	KB 15 1220 2440	125.17	4	500.68
Panel dimension: 62.5 cm x 244 cm – 24-1/2" x 96"				
19 - 3/4	KB 19 625 2440	60.52	6	363.12
25 - 1	KB 25 625 2440	64.28	4	257.12
38 - 1-1/2	KB 38 625 2440	73.66	3	220.98
50 - 2	KB 50 625 2440	82.75	3	248.25
Panel dimension: 122 cm x 305 cm – 48" x 120"				
15 - 5/8	KB 15 1220 3050	150.20	4	600.80

Schluter®-KERDI-BOARD-V

Schluter®-KERDI-BOARD-V is a vertically grooved substrate and building panel for creating curved elements. If a larger expanse of panels is required, several panels can be connected along the edges with thin-set mortar, Schluter®-KERDI-FIX adhesive, or double-sided adhesive tape.

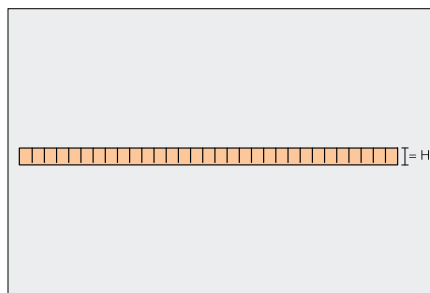

**Schluter®-SET,
Schluter®-ALL-SET,
Schluter®-FAST-SET**
See page 152

Schluter®-KERDI-BOARD-V				
Grooved substrate and building panel				
H = mm - in.	Item No.	\$ / Panel	Panels / Bundle	\$ / Bundle
Panel dimension: 62.5 cm x 244 cm – 24-1/2" x 96"				
19 - 3/4	KB 19 625 2440 V	73.56	6	441.36
25 - 1	KB 25 625 2440 V	80.12	4	320.48
38 - 1-1/2	KB 38 625 2440 V	88.20	3	264.60
50 - 2	KB 50 625 2440 V	97.28	3	291.84



Schluter®-KERDI-BOARD-E

Schluter®-KERDI-BOARD-E is an L-shaped panel used to create corners and pipe or column coverings.

The panels feature a V-shaped groove and are shipped in a space-saving flat design, which makes them easy to store. The flat panels are also quick to cut to the necessary dimensions. Thin-set mortar, Schluter®-KERDI-FIX adhesive, or double-sided adhesive tape is applied to the V-groove. The panels are then folded prior to installation.

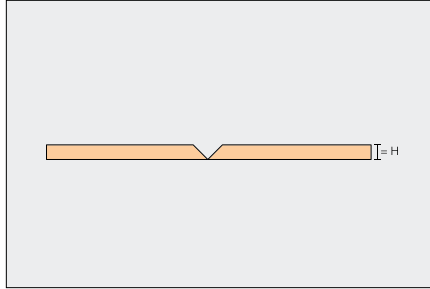

Schluter®-KERDI-BOARD-E				
L-shaped panel				
H = mm - in.	Item No.	\$ / Panel	Panels / Bundle	\$ / Bundle
Panel dimension: 62.5 cm x 244 cm – 24-1/2" x 96"				
19 - 3/4	KB 19 625 2440 E	79.35	6	476.10
25 - 1	KB 25 625 2440 E	84.24	4	336.96

Schluter®-KERDI-BOARD-U

Schluter®-KERDI-BOARD-U is a U-shaped panel used to create pipe or column coverings.

The panels feature V-shaped grooves and are shipped in a space-saving flat design, which makes them easy to store. The flat panels are also quick to cut to the necessary dimensions. Thin-set mortar, Schluter®-KERDI-FIX adhesive, or double-sided adhesive tape is applied to the V-grooves. The panels are then folded prior to installation.

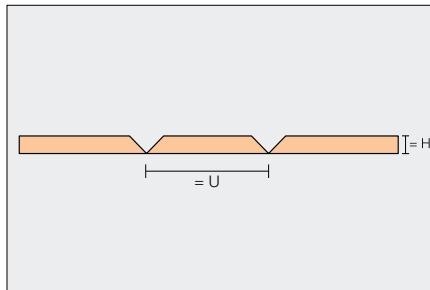

Schluter®-KERDI-BOARD-U				
U-shaped panel				
H = mm - in.	Item No.	\$ / Panel	Panels / Bundle	\$ / Bundle
Panel dimension: 62.5 cm x 244 cm – 24-1/2" x 96"				
U = 20 cm – 7-7/8"				
19 - 3/4	KB 19 625 2440 U 20	99.60	6	597.60
U = 30 cm – 11-13/16"				
19 - 3/4	KB 19 625 2440 U 30	99.60	6	597.60

Schluter®-KERDI-BOARD-SC

Schluter®-KERDI-BOARD-SC is a prefabricated shower curb made of KERDI-BOARD that is designed to integrate with the Schluter®-Shower System. The curb is lightweight, stable, and load bearing. It can be used in conjunction with the KERDI-SHOWER prefabricated shower trays as well as in mortar bed applications. KERDI-BOARD-SC is quick and easy to install, waterproof and ready to tile, making it a simple solution for tiled shower curbs.

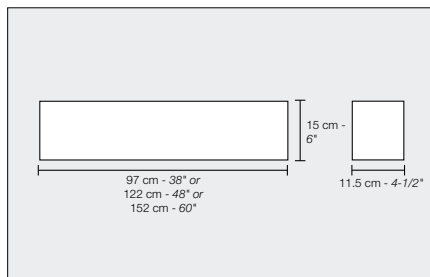

Schluter®-KERDI-BOARD-SC		
Curb		
Item No.	Dimensions	\$ / Unit
KBSC 115 150 970	97 cm x 15 cm x 11.5 cm (38" x 6" x 4-1/2")	67.00
KBSC 115 150 1220	122 cm x 15 cm x 11.5 cm (48" x 6" x 4-1/2")	75.00
KBSC 115 150 1524	152 cm x 15 cm x 11.5 cm (60" x 6" x 4-1/2")	103.00



Schluter®-KERDI-BOARD-SN

Schluter®-KERDI-BOARD-SN is a prefabricated shower niche made of Schluter®-KERDI-BOARD that can be installed in both Schluter®-KERDI and Schluter®-KERDI-BOARD wall assemblies. The shower niche features a 1/2" (12.5 mm) -thick by 2" (50 mm) -wide integrated bonding flange and is available in 4 different sizes. Larger sizes include a prefabricated KERDI-BOARD shelf that can be installed at any height to create separate compartments within the shower niche if desired.

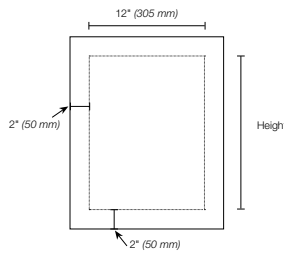

Schluter®-KERDI-BOARD-SN					
Niche					
Item No.	Height	Width	Depth	Shelf	\$/ Unit
KB 12 SN 305 152 A	6" (152 mm)	12" (305 mm)	3-1/2" (89 mm)	-	56.96
KB 12 SN 305 305 A	12" (305 mm)	12" (305 mm)	3-1/2" (89 mm)	-	68.22
KB 12 SN 305 508 A1	20" (508 mm)	12" (305 mm)	3-1/2" (89 mm)	1	92.21
KB 12 SN 305 711 A1	28" (711 mm)	12" (305 mm)	3-1/2" (89 mm)	1	110.21

Schluter®-KERDI-BOARD-SB

Schluter®-KERDI-BOARD-SB is a prefabricated shower bench made of KERDI-BOARD that is designed to integrate with the Schluter®-Shower System. The bench is lightweight, stable, and load bearing. It features a sloped surface to prevent the accumulation of water. KERDI-BOARD-SB is quick and easy to install, waterproof and ready to tile, making it a simple solution for tiled shower benches.

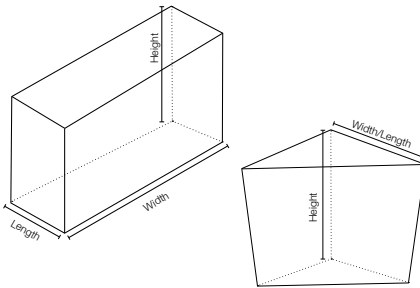

Includes 2 inside and 2 outside KERDI-KERECK waterproofing corners.

Schluter®-KERDI-BOARD-SB					
Bench					
Item No.	Width	Length	Height	Shape	\$/ Unit
KBSB 410 TA	16" (41 cm)	16" (41 cm)	20" (51 cm)	Triangular	185.00
KBSB 610 TA	24" (61 cm)	24" (61 cm)	20" (51 cm)	Triangular	250.00
KBSB 290 970 RA	38" (97 cm)	11-1/2" (29 cm)	20" (51 cm)	Rectangular	310.00
KBSB 410 1220 RA	48" (122 cm)	16" (41 cm)	20" (51 cm)	Rectangular	409.00



Schluter®-KERDI-BOARD-KIT

Complete kit for waterproofing walls around bathtubs and acrylic shower bases. Refer to page 141.





Schluter®-KERDI-BOARD-ZC

Schluter®-KERDI-BOARD-ZC is a brushed stainless steel, U-shaped profile with one perforated anchoring leg. It is used to finish the edges of countertops, vanities, and similar structures in conjunction with the Schluter®-RONDEC or Schluter®-QUADEC finishing profiles.

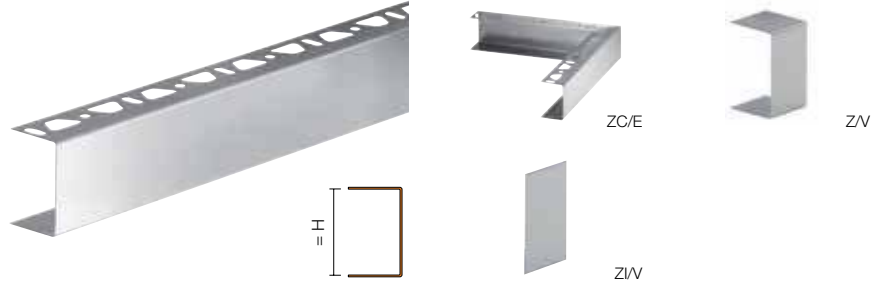

Schluter®-KERDI-BOARD-ZC		
U-shaped brushed stainless steel profile with 1 perforated anchoring leg		
H = mm - in.	Item No.	\$ / Length
Length = 2.50 m - 8' 2-1/2"		
38 - 1-1/2	KB ZC 38 EB	56.70
50 - 2	KB ZC 50 EB	61.95

Schluter®-KERDI-BOARD-ZC/E		
Brushed stainless steel outside corner piece for ZC		
H = mm - in.	Item No.	\$ / Unit
38 - 1-1/2	E/KB ZC 38 EB	20.44
50 - 2	E/KB ZC 50 EB	20.44

Schluter®-KERDI-BOARD-Z/V		
Brushed stainless steel connector for ZC and ZA		
H = mm - in.	Item No.	\$ / Unit
38 - 1-1/2	V/KB Z 38 EB	6.44
50 - 2	V/KB Z 50 EB	6.44

Schluter®-KERDI-BOARD-ZI/V		
Stainless steel internal connector for ZC and ZA		
H = mm - in.	Item No.	\$ / Unit
38 - 1-1/2	V/KB ZI 38 E	3.99
50 - 2	V/KB ZI 50 E	3.99

Schluter®-KERDI-BOARD-ZA

Schluter®-KERDI-BOARD-ZA is a brushed stainless steel, U-shaped profile with two perforated anchoring legs. It is used to finish visible edges of partition walls and shelves.

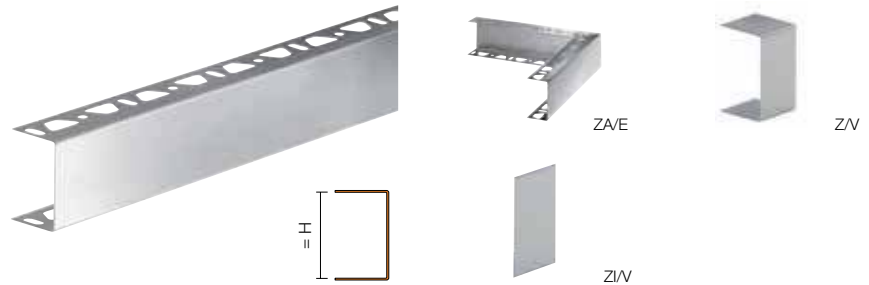

Schluter®-KERDI-BOARD-ZA		
U-shaped brushed stainless steel profile with 2 perforated anchoring legs		
H = mm - in.	Item No.	\$ / Length
Length = 2.50 m - 8' 2-1/2"		
19 - 3/4	KB ZA 19 EB	48.13
25 - 1	KB ZA 25 EB	51.98
38 - 1-1/2	KB ZA 38 EB	56.70
50 - 2	KB ZA 50 EB	61.95

Schluter®-KERDI-BOARD-ZA/E		
Brushed stainless steel outside corner piece for ZA		
H = mm - in.	Item No.	\$ / Unit
38 - 1-1/2	E/KB ZA 38 EB	20.44
50 - 2	E/KB ZA 50 EB	20.44

Schluter®-KERDI-BOARD-Z/V		
Brushed stainless steel connector for ZC and ZA		
H = mm - in.	Item No.	\$ / Unit
19 - 3/4	V/KB Z 19 EB	6.44
25 - 1	V/KB Z 25 EB	6.44
38 - 1-1/2	V/KB Z 38 EB	6.44
50 - 2	V/KB Z 50 EB	6.44

Schluter®-KERDI-BOARD-ZI/V		
Stainless steel internal connector for ZC and ZA		
H = mm - in.	Item No.	\$ / Unit
19 - 3/4	V/KB ZI 19 E	3.99
25 - 1	V/KB ZI 25 E	3.99
38 - 1-1/2	V/KB ZI 38 E	3.99
50 - 2	V/KB ZI 50 E	3.99



Schluter®-KERDI-BOARD-ZB

Schluter®-KERDI-BOARD-ZB is a stainless steel, U-shaped profile with three-sided perforation. It is used to fasten and stabilize partition walls and other structures made of KERDI-BOARD panels. The surfaces of the profile are hidden by the tile covering.

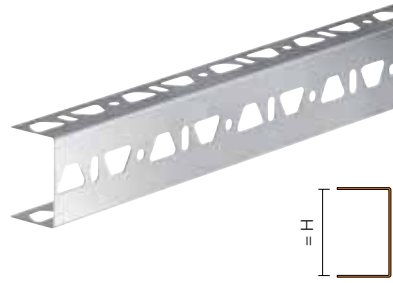

Schluter®-KERDI-BOARD-ZB		
U-shaped stainless steel profile with 3 perforated anchoring legs		
H = mm - in.	Item No.	\$ / Length
Length = 2.50 m - 8' 2-1/2"		
19 - 3/4	KB ZB 19 E	41.48
25 - 1	KB ZB 25 E	44.80
38 - 1-1/2	KB ZB 38 E	48.48
50 - 2	KB ZB 50 E	53.20

Schluter®-KERDI-BOARD-ZW

Schluter®-KERDI-BOARD-ZW is a stainless steel angle profile with two trapezoid perforated anchoring legs. It is used to fasten and stabilize structures made of KERDI-BOARD panels. It is attached to the substrate with either screws or thin-set mortar.

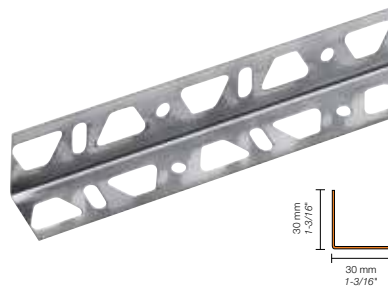

Schluter®-KERDI-BOARD-ZW	
Stainless steel angle profile	
Item No.	\$ / Length
Length = 15 cm - 6"	
KB ZW 30 E/15	1.61
Length = 2.50 m - 8' 2-1/2"	
KB ZW 30 E	23.98

Schluter®-KERDI-BOARD-ZSD

Schluter®-KERDI-BOARD-ZSD are anchors used to provide additional mechanical attachment of KERDI-BOARD when the bond between the thin-set mortar and the substrate is questionable.

Appropriate drill bit size: 8 mm - 5/16".
Drill hole 10 mm - 3/8" deeper than anchor length.



Schluter®-KERDI-BOARD-ZSD			
Stainless steel anchor			
Size = cm - in.	Item No.	Anchors / Box	\$ / Box
9 - 3-1/2	KB ZSD 90 E	25	27.65
11 - 4-5/16	KB ZSD 110 E	25	31.92
Galvanized steel anchor			
9 - 3-1/2	KB ZSD 90 Z	25	14.84
11 - 4-5/16	KB ZSD 110 Z	25	17.08



Schluter®-KERDI-BOARD-ZT/-ZS

Schluter®-KERDI-BOARD-ZT are galvanized steel washers used to fasten KERDI-BOARD to stud framing. They feature tabs that penetrate the surface of the KERDI-BOARD and temporarily hold the washers in place to enable quick installation of the corresponding screws. **Schluter®-KERDI-BOARD-ZS** are screws used to fasten KERDI-BOARD to stud framing with the corresponding washers.

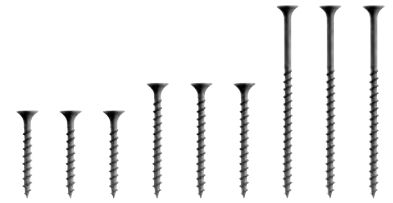

Schluter®-KERDI-BOARD-ZT			
Galvanized steel attachment washer			
Size = mm - in.	Item No.	Washers / Box	\$ / Box
32 - 1-1/4	KB ZT 32 Z	100	10.98
32 - 1-1/4	KB ZT 32 Z/L	1000	90.98

Schluter®-KERDI-BOARD-ZS			
Threaded screw for stud framing			
Size = mm - in.	Item No.	Screws / Box	\$ / Box
41 - 1-5/8	KB ZS 35 G	200	14.98
50 - 2	KB ZS 55 G	100	10.98
75 - 3	KB ZS 75 G	100	16.76

Schluter®-KERDI-BOARD-ZT/-ZS			
Washer and Screw Set			
Size = mm - in.	Item No.	Pieces / Box	\$ / Box
41 - 1-5/8	KB ZS 35 GT 32 Z	40 each	12.49
▲ 41 - 1-5/8	KB ZS 35 GT 32 Z 100	100 each	23.55



Convenient retail packaging.

Schluter®-KERDI-BOARD-ZDK

Schluter®-KERDI-BOARD-ZDK is a double-sided adhesive tape used to attach KERDI-BOARD panels in joint areas or similar.



Schluter®-KERDI-BOARD-ZDK			
Double-sided tape			
Item No.	Width	Length	\$ / Roll
KB ZDK 12/10 M	12.5 mm - 1/2"	10 m - 33'	9.17
KB ZDK 19/10 M	19 mm - 3/4"	10 m - 33'	14.21
KB ZDK 30/10 M	30 mm - 1-3/16"	10 m - 33'	22.33



Schluter®-KERDI-BOARD-ZSA

Schluter®-KERDI-BOARD-ZSA is an adhesive tape for reinforcing the joint areas of KERDI-BOARD panels.



Schluter®-KERDI-BOARD-ZSA			
Joint reinforcement tape			
Item No.	Width	Length	\$ / Roll
KB ZSA 100/45 M	100 mm - 4"	45 m - 148'	16.31

Schluter®-KERDI-BOARD-ZFP

Schluter®-KERDI-BOARD-ZFP is a flat plastic profile, which is adhered behind the KERDI-BOARD-ZA U-shaped profile to improve fastening of hardware with screws.



Schluter®-KERDI-BOARD-ZFP		
Flat plastic profile		
Width mm - in.	Item No.	\$ / Length
Length = 2.50 m - 8' 2-1/2"		
35 - 1-3/8	KB ZFP 35	10.50



Schluter®-Systems

WATERPROOFING AND UNCOUPLING MEMBRANES

Ceramic and stone tiles are durable, easy to maintain, and hygienic, representing the ideal surface coverings. However, today's lightweight construction methods can make the installation of hard surface coverings particularly challenging.

Schluter®-Systems has developed state-of-the-art installation systems that address the problems associated with today's construction methods, allowing the installation of ceramic and stone tiles on virtually any surface.



Schluter®-DITRA and Schluter®-DITRA-XL

Schluter®-DITRA and **Schluter®-DITRA-XL** are polyethylene uncoupling membranes with a grid structure of square cutback cavities and an anchoring fleece laminated to the underside. DITRA and DITRA-XL provide uncoupling through the open rib structure, which allows for in-plane movement that effectively neutralizes the differential movement stresses between the substrate and the tile, thus eliminating the major cause of cracking and delaminating of the tiled surface. In conjunction with tile coverings, DITRA and DITRA-XL form an uncoupling, waterproofing, and vapor management layer, while providing support/load distribution. The combination of these four essential functions allows for the successful installation of tile over a wide range of substrates, including plywood/OSB, concrete, gypsum, heated floors, etc.

Schluter®-DITRA is 1/8" (3 mm) thick, which minimizes tile assembly thickness and reduces transitions to lower surface coverings (e.g., carpet, engineered wood, and vinyl). DITRA allows for ceramic tile application over single-layer plywood or OSB subfloors on joists spaced up to 19.2" (488 mm) o.c. DITRA is listed by cUPC®.

Schluter®-DITRA-XL is 5/16" (7 mm) thick, which permits even transitions between tile and 3/4"-thick hardwood flooring. DITRA-XL allows for ceramic tile application over single-layer plywood/OSB subfloors on joists spaced up to 24" (610 mm) o.c.

DITRA and DITRA-XL were evaluated according to the "Standard Method for the Testing and Evaluation of Volatile Organic Chemical Emissions from Indoor Sources Using Environmental Chambers, Version 1.1" for California Specification 01350 and found to comply with the VOC requirements. California Specification 01350 is referenced by various green building standards and rating systems.

For complete information, a step-by-step installation video and the DITRA Installation Handbook are available for download at: www.schluter.com or by contacting our Customer Service.

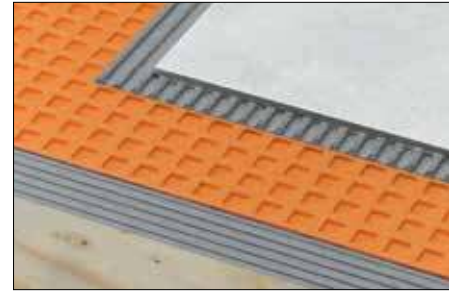
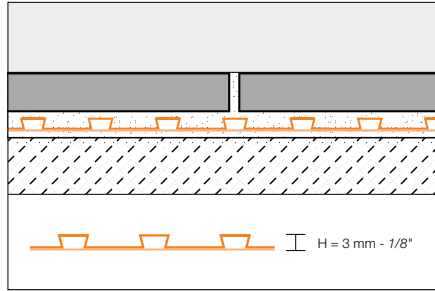

Schluter®-DITRA			
Uncoupling and waterproofing membrane (1/8" - 3 mm)			
Item No.	Dimensions	\$ / ft ² *	\$ / Roll
DITRA 5M	1 m x 5 m = 5 m ² (3' 3" x 16' 5" = 54 ft ²)	2.25	121.50
DITRA 150	1 m x 14 m = 14 m ² (3' 3" x 45' 9" = 150 ft ²)	2.12	318.00
DITRA 30M	1 m x 30 m = 30 m ² (3' 3" x 98' 5" = 323 ft ²)	1.98	639.54

* The price per square foot is for estimation purposes only. Please order using the price per roll.

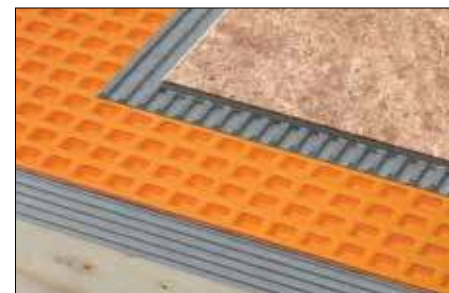
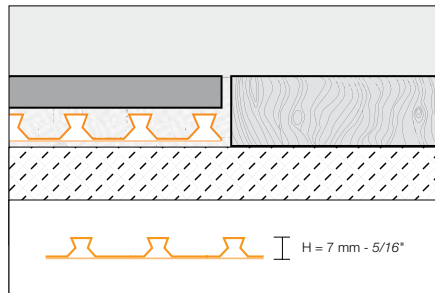

Schluter®-DITRA-XL			
Uncoupling and waterproofing membrane (5/16" - 7 mm)			
Item No.	Dimensions	\$ / ft ² *	\$ / Roll
DITRA-XL/175	1 m x 16.25 m = 16.25 m ² (3' 3" x 53' 3" = 175 ft ²)	2.25	393.99

* The price per square foot is for estimation purposes only. Please order using the price per roll.



**Schluter®-SET,
Schluter®-ALL-SET,
Schluter®-FAST-SET**
See page 152

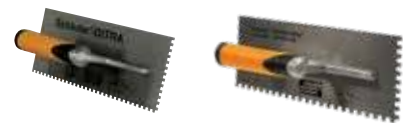

**Schluter®-DITRA-TROWEL and
Schluter®-DITRA-XL-TROWEL**
See page 154



Schluter®-KERDI and Schluter®-KERDI-DS

Schluter®-KERDI is a pliable sheet-applied polyethylene waterproofing membrane and vapor retarder that guarantees uniform thickness. It is covered with an anchoring fleece on both sides to anchor the membrane in thin-set mortar and is suitable for waterproofing in conjunction with tiled surfaces on walls and floors. KERDI is 8-mil thick and has a water vapor permeance of 0.90 perms, when tested according to ASTM E96, using Procedure E at 90% relative humidity.

Schluter®-KERDI-DS is a bonded waterproofing membrane and vapor retarder with very low water vapor permeance for use in continuous use steam rooms and similar applications. KERDI-DS is 20-mil thick and features additives to produce a water vapor permeance of 0.19 perms, when tested according to ASTM E96, using Procedure E at 90% relative humidity.

KERDI and KERDI-DS meet the American National Standard for Load Bearing, Bonded, Waterproof Membranes for Thin-Set Ceramic Tile and Dimension Stone Installations (ANSI A118.10). The membranes are listed by cUPC® and evaluated by ICC-ES (Report Nos. ESR-2467 and PMG-1204).

KERDI and KERDI-DS have been evaluated according to the "Standard Method for the Testing and Evaluation of Volatile Organic Chemical Emissions from Indoor Sources Using Environmental Chambers, Version 1.1" for California Specification 01350 and found to comply with the VOC requirements. California Specification 01350 is referenced by various green building standards and rating systems.

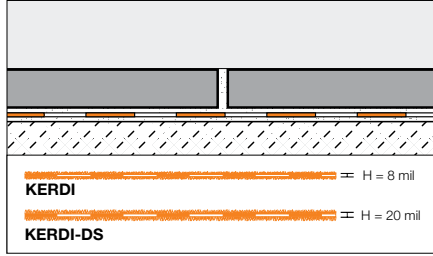

Note: 1 mil = 1 one-thousandth of an inch

Schluter®-KERDI			
Waterproofing membrane			
Item No.	Dimensions	\$ / ft ² *	\$ / Roll
Roll width: 1 m - 3' 3"			
KERDI 200/5M	1 m x 5 m = 5 m ² (3' 3" x 16' 5" = 54 ft ²)	2.25	121.50
KERDI 200/7M	1 m x 7 m = 7 m ² (3' 3" x 23' = 75 ft ²)	2.23	167.41
KERDI 200/10M	1 m x 10 m = 10 m ² (3' 3" x 33' = 108 ft ²)	2.21	238.68
KERDI 200/20M	1 m x 20 m = 20 m ² (3' 3" x 65' 7" = 215 ft ²)	2.08	447.20
KERDI 200	1 m x 30 m = 30 m ² (3' 3" x 98' 5" = 323 ft ²)	1.98	639.54
Roll width: 2 m - 6' 7"			
▲ KERDI 200200	2 m x 30 m = 60 m ² (6' 7" x 98' 5" = 646 ft ²)	1.98	1279.08

Schluter®-KERDI-DS			
Waterproofing membrane			
Item No.	Dimensions	\$ / ft ² *	\$ / Roll
KERDI-DS	1 m x 30 m = 30 m ² (3' 3" x 98' 5" = 323 ft ²)	2.35	759.05

* The price per square foot is for estimation purposes only. Please order using the price per roll.



**Schluter®-SET,
Schluter®-ALL-SET,
Schluter®-FAST-SET**
See page 152



Schluter®-KERDI-TROWEL
See page 154

The WIDE Roll

- ✓ Fewer seams
- ✓ Faster installation
- ✓ Wide format covers wall area from floor to standard shower head height

NEW!
6' 7" (2 m) wide roll

Schluter®-KERDI-BAND

Schluter®-KERDI-BAND is a waterproofing strip used to seal butt joints and floor/wall connections with the Schluter®-KERDI, DITRA, and DITRA-HEAT membranes, as well as joints, corners, and fastener penetrations with the Schluter®-KERDI-BOARD building panels.

Note: 1 mil = 1 one-thousandth of an inch

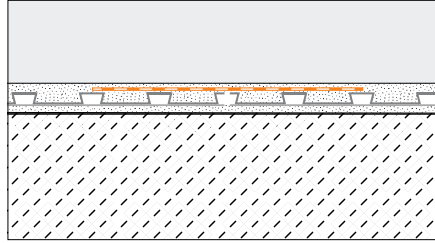

Schluter®-KERDI-BAND						
Waterproofing strip						
Item No.	Width	Length	Thickness	\$ / ft *	\$ / Roll	
125 mm - 5" width						
KEBA 100/125/5M	125 mm - 5"	5 m - 16' 5"	4 mil	1.41	23.07	
KEBA 100/125/10M	125 mm - 5"	10 m - 33'	4 mil	1.33	43.82	
KEBA 100/125	125 mm - 5"	30 m - 98' 5"	4 mil	1.10	107.87	
▲ KEBA100/125/300	125 mm - 5"	300 m - 984' 3"	4 mil	.99	970.83	
185 mm - 7-1/4" width						
KEBA 100/185/5M	185 mm - 7-1/4"	5 m - 16' 5"	4 mil	1.84	30.19	
KEBA 100/185	185 mm - 7-1/4"	30 m - 98' 5"	4 mil	1.52	149.87	
250 mm - 10" width						
KEBA 100/250/5M	250 mm - 10"	5 m - 16' 5"	4 mil	2.25	36.97	
KEBA 100/250	250 mm - 10"	30 m - 98' 5"	4 mil	1.96	192.82	

* The price per foot is for estimation purposes only. Please order using the price per roll.

Schluter®-KERDI-FLEX

Schluter®-KERDI-FLEX is a flexible polyethylene waterproofing strip used to seal movement joints over Schluter®-DITRA in specialty applications where large movements are expected, i.e. over expansion joints or construction joints.

Note: 1 mil = 1 one-thousandth of an inch

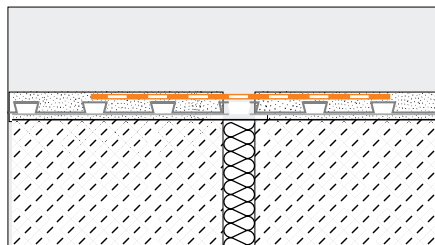

Schluter®-KERDI-FLEX						
Waterproofing strip for use above movement joints						
Item No.	Width	Length	Thickness	\$ / ft *	\$ / Roll	
FLEX 125/5M	125 mm - 5"	5 m - 16' 5"	12 mil	2.62	42.97	
FLEX 250/5M	250 mm - 10"	5 m - 16' 5"	12 mil	4.24	69.64	
FLEX 125/30	125 mm - 5"	30 m - 98' 5"	12 mil	1.99	196.21	
FLEX 250/30	250 mm - 10"	30 m - 98' 5"	12 mil	3.62	356.36	

* The price per foot is for estimation purposes only. Please order using the price per roll.



Schluter®-KERDI-KERECK-F

Schluter®-KERDI-KERECK-F are preformed, seamless corners made of Schluter®-KERDI for waterproofing inside and outside corners.

Note: 1 mil = 1 one-thousandth of an inch

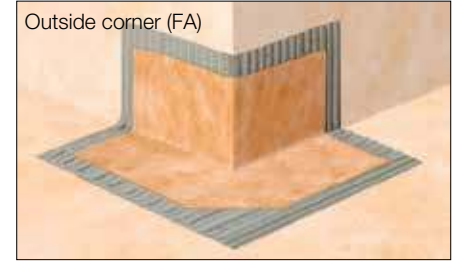
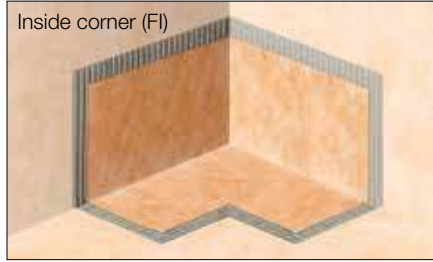

Schluter®-KERDI-KERECK-F			
Waterproofing for 90° corners			
Item No.	Thickness	Packaging	\$ / Package
KERECK/FI 2	4 mil	2 Inside corners	17.36
KERECK/FA 2	4 mil	2 Outside corners	17.36
Waterproofing for 135° corners			
KERECK 135 FI 2	4 mil	2 Inside corners	17.74

Schluter®-KERDI-KERECK-F			
Waterproofing for corners			
Item No.	Thickness	Packaging	\$ / Package
KERECK/FI 10	4 mil	10 Inside corners	86.75
KERECK/FA 10	4 mil	10 Outside corners	86.75
Waterproofing for 135° corners			
KERECK 135 FI 10	4 mil	10 Inside corners	87.80

Schluter®-KERDI-KERS-B

Schluter®-KERDI-KERS-B are preformed, seamless corners for waterproofing 135° angles between triangular shower benches and walls or the tops of curbs in neo-angle shower applications.

Note: 1 mil = 1 one-thousandth of an inch

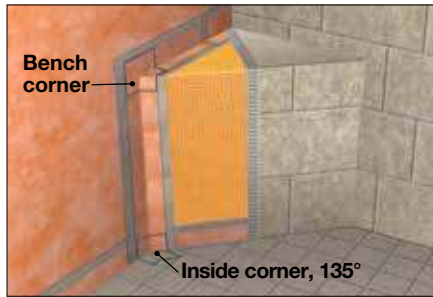

Schluter®-KERDI-KERS-B				
Waterproofing corners				
Item No.	Thickness	Description	Packaging	\$ / Package
KERECK 135 FI 2	4 mil	Inside corner, 135°	2 units	17.74
KERECK 135 FI 10	4 mil	Inside corner, 135°	10 units	87.80
KERSB 135 K LR	4 mil	Bench corners	1 right and 1 left	37.29
KERSB 135 K 5LR	4 mil	Bench corners	5 right and 5 left	177.13
KERSB 135 K	4 mil	Bench/neo-angle corner kit	1 right and 1 left bench corner, and 2 135° inside corners	55.03

Schluter®-KERDI-KERS

Schluter®-KERDI-KERS are preformed, seamless corners made of Schluter®-KERDI for waterproofing floor/wall/shower base connections in curbless shower applications where the Schluter®-KERDI-LINE linear drain is installed adjacent to the wall.

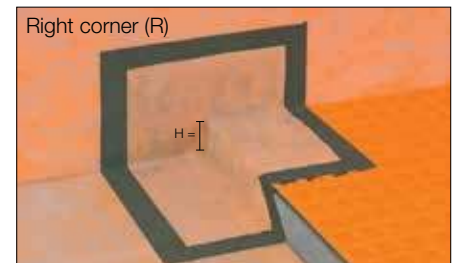
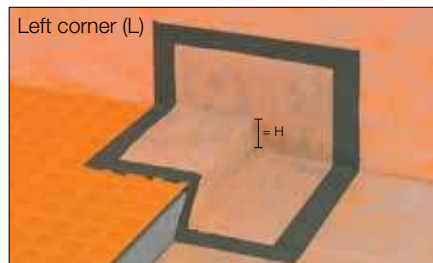

Schluter®-KERDI-KERS				
Waterproofing for corners				
Item No.	H = mm - in.	Thickness	Description	\$ / Unit
KERS 20 L	20 - 3/4	4 mil	Left inside corner	20.60
KERS 28 L	28 - 1-3/32	4 mil	Left inside corner	20.60
KERS 20 R	20 - 3/4	4 mil	Right inside corner	20.60
KERS 28 R	28 - 1-3/32	4 mil	Right inside corner	20.60

Schluter®-KERDI-SEAL-PS/-MV

Schluter®-KERDI-SEAL-PS/-MV prefabricated seals are cut sections of the Schluter®-KERDI waterproofing membrane designed to seal protrusions through the Schluter®-KERDI or Schluter®-DITRA/DITRA-XL, as well as Schluter®-KERDI-BOARD building panels. Schluter®-KERDI-SEAL-PS and -MV feature overmolded rubber gaskets and are used to seal pipe protrusions and protect moisture-sensitive solid backing panels at the mixing valve.

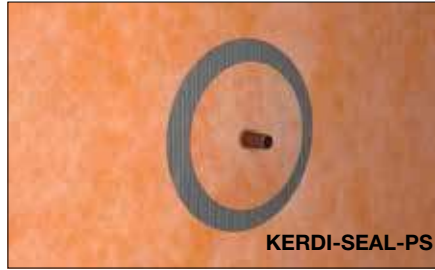

KERDI-SEAL-PS



KERDI-SEAL-MV

Note: 1 mil = 1 one-thousandth of an inch

Schluter®-KERDI-SEAL-PS

Pipe seal with overmolded rubber gasket

Item No.	Pipe nipple opening diam.	Thickness	Packaging	\$ / Package
KMS185/12	1/2" - 12.5 mm	4 mil	1 unit	7.48
KMS185/20	3/4" - 20 mm	4 mil	1 unit	7.48
KMS10185/12	1/2" - 12.5 mm	4 mil	10 units	67.32
KMS10185/20	3/4" - 20 mm	4 mil	10 units	67.32

Schluter®-KERDI-SEAL-MV

Mixing valve seal with overmolded rubber gasket

Item No.	Mixing valve opening diam.	Thickness	Packaging	\$ / Package
KMSMV235/114	4-1/2" - 114 mm	4 mil	1 unit	8.63
KMSMV10235/114	4-1/2" - 114 mm	4 mil	10 units	77.67

Schluter®-KERDI-KM

Schluter®-KERDI-KM prefabricated seal is cut sections of the Schluter®-KERDI waterproofing membrane designed to seal protrusions through the KERDI or Schluter®-DITRA/DITRA-XL membranes. KERDI-KM is designed to be used in conjunction with Schluter®-KERDI-FIX or equivalent sealant to seal around pipes or other similar elements.



Schluter®-KERDI-KM

Pipe seal

Item No.	Pipe nipple opening diam.	Thickness	Packaging	\$ / Package
KM5117/22	7/8" - 22 mm	4 mil	5 units	10.66

Schluter®-KERDI-FIX

Schluter®-KERDI-FIX is a single-component sealing and bonding compound with a silane-modified polymer base. It is odor-neutral, UV- and weather-resistant, and contains no solvents. KERDI-FIX is elastomeric and bonds well to most materials, such as wood, stone, concrete, metal, glass, and many plastics. KERDI-FIX is suitable for bonding the Schluter®-KERDI waterproofing membrane and Schluter®-KERDI-BAND to fixed building elements. KERDI-FIX is also suitable for use as a sealant.



Schluter®-KERDI-FIX

Cartridge (290 ml – 9.81 oz.)

Item No.	\$ / Unit
KERDIFIX / + color*	28.48

Schluter®-KERDI-FIX

Tube (100 ml – 3.38 oz.) - Grey (G)

Item No.	\$ / Unit
KERDIFIX 100 G	16.40

***Color Codes**





Schluter®-DITRA-HEAT-E

ELECTRIC FLOOR WARMING SYSTEM WITH INTEGRATED UNCOUPLING TECHNOLOGY

Ceramic and stone tiles are the ideal surface coverings because they are durable, easy to maintain, and hygienic. However, two common barriers to the selection of tile as a floor covering are concerns about cracking and the perception that tiles are cold.

Schluter®-DITRA-HEAT integrates customizable, comfortable electric floor warming with the functions associated with DITRA: uncoupling, waterproofing, vapor management and support to ensure a long lasting installation, thereby addressing the two most common concerns.



Wi-Fi
thermostat for
DITRA-HEAT



Schluter®-DITRA-HEAT and Schluter®-DITRA-HEAT-DUO

Schluter®-DITRA-HEAT and **DITRA-HEAT-DUO** are polypropylene membranes with a cut-back stud structure and an anchoring fleece laminated to the underside. Both membranes are designed to secure the DITRA-HEAT-E-HK electric floor heating cables and provide uncoupling, waterproofing, vapor management and support to ensure a long lasting installation.

DITRA-HEAT-DUO offers the same functions as DITRA-HEAT, but features a thicker bonding fleece that adds two more benefits, while still supporting the covering to ensure a lasting installation:

Sound Control

DITRA-HEAT-DUO reduces impact sound transmission through floor-ceiling assemblies, making it ideal for multi-story construction. DITRA-HEAT-DUO provides a ΔIIC contribution of 20, when tested per ASTM E2179 in a thin-set assembly with porcelain tile.

Thermal Break

DITRA-HEAT-DUO reduces heat loss to the substrate to improve the floor warming response time over concrete substrates by up to 70%.

The thickness of the mat, including the stud structure, of DITRA-HEAT is 1/4" (5.5 mm) and DITRA-HEAT-DUO is 5/16" (8 mm).

For complete information, a step-by-step installation video, Installation Handbook, and Technical Data Sheet are available for download at: www.schluter.com or by contacting our Customer Service.

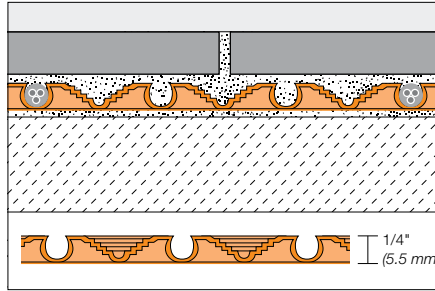

Schluter®-DITRA-HEAT

Uncoupling and waterproofing membrane

Item No.	Dimensions	Format	\$ / ft ² *	\$ / Unit
DH5 12M	3' 3" x 41' 1" = 134.5 ft ² (1 m x 12.5 m = 12.5 m ²)	Roll	2.63	354.14
DH5 MA	3' 3" x 2' 7" = 8.6 ft ² (1 m x 0.8 m = 0.8 m ²)	Sheet	2.67	22.92

* The price per square foot is for estimation purposes only. Please order using the price per roll or per sheet.

U.S. Pat. No. 8,950,141; 9,428,920; 9,797,146 and U.S. DES. PAT. No. D706459

Canadian Pat. No. 2,822,392

Canada © Schluter-Systems L.P. and other patents pending

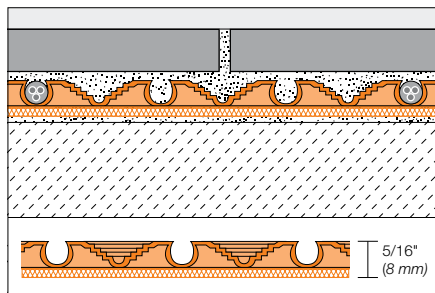

Schluter®-DITRA-HEAT-DUO

Uncoupling and waterproofing membrane with sound control and thermal break

Item No.	Dimensions	Format	\$ / ft ² *	\$ / Unit
DHD 810 M	3' 3" x 33' = 108 ft ² (1 m x 10 m = 10 m ²)	Roll	3.69	398.00
DHD 8 MA	3' 3" x 2' 7" = 8.6 ft ² (1 m x 0.8 m = 0.8 m ²)	Sheet	3.84	33.00

* The price per square foot is for estimation purposes only. Please order using the price per roll or per sheet.

Patent pending



**Schluter®-SET,
Schluter®-ALL-SET,
Schluter®-FAST-SET**
See page 152



Schluter®-DITRA-HEAT/-DITRA-XL-TROWEL
See page 154



Schluter®-DITRA-HEAT-E-HK

Schluter®-DITRA-HEAT-E-HK are twisted pair heating cables designed for integration with the DITRA-HEAT uncoupling membrane in interior floor warming applications. The cables can be installed without returning to the thermostat and produce virtually zero electromagnetic fields.

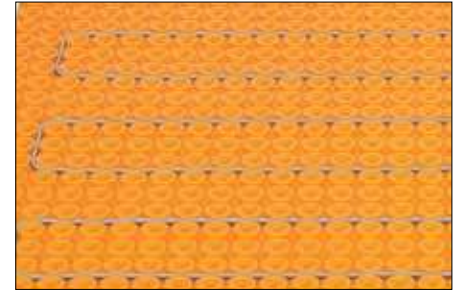

BEFORE ordering heating cables, see IMPORTANT ordering information on page 106.

Schluter®-DITRA-HEAT-E-HK													
Heating cable													
Item No.	Heating Cable Length		Area Covered per Cable Spacing				Total Power (W)	Avg. Power per Unit Area per Cable Spacing				Current (Amps)	\$ / Length
	(ft)	(m)	Regular 3 Stud		Alternating 3-2 Stud			Regular 3 Stud		Alternating 3-2 Stud			
Heating Cable (120 V)													
DHE HK 120 11	35.3	10.8	10.7	1.0	8.9	0.8	135	12.6	136	15.2	164	1.1	198.35
DHE HK 120 16	52.9	16.1	16.0	1.5	13.3	1.2	203	12.7	136	15.2	164	1.7	221.23
DHE HK 120 21	70.5	21.5	21.3	2.0	17.8	1.7	270	12.7	136	15.2	164	2.3	265.28
DHE HK 120 27	88.2	26.9	26.7	2.5	22.2	2.1	338	12.7	136	15.2	164	2.8	285.05
DHE HK 120 32	105.8	32.2	32.0	3.0	26.7	2.5	405	12.7	136	15.2	164	3.4	308.41
DHE HK 120 38	124.1	37.8	37.5	3.5	31.3	2.9	475	12.7	136	15.2	164	4.0	330.51
DHE HK 120 43	141.1	43.0	42.7	4.0	35.6	3.3	540	12.7	136	15.2	164	4.5	349.82
DHE HK 120 51	169.8	51.8	51.4	4.8	42.8	4.0	650	12.7	136	15.2	164	5.4	392.73
DHE HK 120 64	212.9	64.9	64.4	6.0	53.7	5.0	815	12.7	136	15.2	164	6.8	435.78
DHE HK 120 73	240.2	73.2	72.7	6.8	60.6	5.6	920	12.7	136	15.2	164	7.7	478.73
DHE HK 120 83	275.5	84.0	83.3	7.7	69.4	6.5	1055	12.7	136	15.2	164	8.8	521.40
DHE HK 120 92	303.0	92.4	91.7	8.5	76.4	7.1	1160	12.7	136	15.2	164	9.7	586.50
DHE HK 120 102	336.9	102.7	101.9	9.5	84.9	7.9	1290	12.7	136	15.2	164	10.7	657.18
DHE HK 120 113	372.2	113.4	112.6	10.5	93.8	8.7	1425	12.7	136	15.2	164	11.9	712.76
DHE HK 120 134	444.0	135.3	134.3	12.5	111.9	10.4	1700	12.7	136	15.2	164	14.2	770.71
Heating Cable (240 V)													
DHE HK 240 11	35.3	10.8	10.7	1.0	8.9	0.8	135	12.6	136	15.2	164	0.6	198.35
DHE HK 240 16	53.1	16.2	16.1	1.5	13.4	1.2	203	12.6	136	15.2	164	0.8	221.00
DHE HK 240 21	70.6	21.5	21.4	2.0	17.8	1.7	270	12.7	136	15.2	164	1.1	265.45
DHE HK 240 27	88.2	26.9	26.7	2.5	22.2	2.1	338	12.7	136	15.2	164	1.4	284.89
DHE HK 240 32	105.8	32.2	32.0	3.0	26.7	2.5	405	12.7	136	15.2	164	1.7	308.41
DHE HK 240 38	124.1	37.8	37.5	3.5	31.3	2.9	475	12.7	136	15.2	164	2.0	330.39
DHE HK 240 43	141.0	43.0	42.6	4.0	35.5	3.3	540	12.7	136	15.2	164	2.3	349.70
DHE HK 240 53	176.3	53.7	53.3	5.0	44.4	4.0	675	12.7	136	15.2	164	2.8	392.81
DHE HK 240 64	211.6	64.5	64.0	5.9	53.3	5.0	810	12.7	136	15.2	164	3.4	435.71
DHE HK 240 75	248.2	75.7	75.1	7.0	62.6	5.8	950	12.7	136	15.2	164	4.0	478.77
DHE HK 240 85	282.1	86.0	85.3	7.9	71.1	6.6	1080	12.7	136	15.2	164	4.5	522.89
DHE HK 240 103	339.4	103.4	102.7	9.5	85.6	7.9	1300	12.7	136	15.2	164	5.4	588.03
DHE HK 240 129	425.8	129.8	128.8	12.0	107.3	10.0	1630	12.7	136	15.2	164	6.8	657.18
DHE HK 240 145	480.5	146.5	145.3	13.5	121.1	11.3	1840	12.7	136	15.2	164	7.7	714.26
DHE HK 240 167	551.0	167.9	166.7	15.5	138.9	12.9	2110	12.7	136	15.2	164	8.8	770.53
DHE HK 240 183	605.9	184.7	183.3	17.0	152.7	14.2	2320	12.7	136	15.2	164	9.7	845.98
DHE HK 240 204	673.8	205.4	203.8	18.9	169.9	15.8	2580	12.7	136	15.2	164	10.7	906.30
DHE HK 240 225	744.4	226.9	225.2	20.9	187.7	17.4	2850	12.7	136	15.2	164	11.9	973.25

Each heating cable includes 1 floor temperature sensor compatible with the Schluter®-DITRA-HEAT-E thermostats and features an approximately 7 ft (2.1 m) long cold lead.

IMPORTANT Ordering Information for Schluter®-DITRA-HEAT Cables

- Do not purchase a heating cable the same size as the area to be tiled; this will be too much heating cable!
- Very important: **Never CUT or modify the heating cable in any way.** This would change the cable resistance, will cause damage to the cable, and could cause cable overheating.
- A cable spacing of 3 studs is standard
- Cable may also be spaced at continuously alternating 3 stud – 2 stud – 3 stud intervals in isolated areas or over the entire floor. This practice may be desirable to increase heat output (e.g., over uninsulated on or below grade concrete subfloors) or to consume more cable length in a given area (e.g., when using the standard 3 stud spacing doesn't allow the selected cable to fit the floor area and respect minimum spacing requirements from walls, partitions, etc.)
- A cable spacing of 4 studs is not recommended, as it can produce inconsistent floor surface temperatures
- Minimum spacing from walls, partitions, and fixed cabinets is 2" (50 mm).
- Minimum spacing from other heat sources (baseboard heaters, fireplaces, etc.) is 8" (200 mm).
- Minimum spacing from any plumbing drain and forced air heating ducts is 4" (100 mm).
- Minimum spacing from the centerline of toilet drain is 7" (180 mm).
- The heating section of the cable must be entirely installed under the floor covering. The installation is characterized as a Type C (Embedded Floor Warming) application. In order to prevent a fire hazard, do not install it anywhere else (e.g. in a wall).
- NEVER install the heating cable under vanities with no air space beneath, bathtub platforms, free-standing bathtubs with no air space beneath, kitchen cabinets or any other fixtures or in clothing closets. Excessive heat will build up in these confined spaces and may cause cable overheating.
- It is helpful to plan the location of a buffer zone, as it is not possible to predict where the heating cable will end. The buffer zone is an area where heating is not essential and heating cable installation is not planned (e.g., behind a toilet or adjacent to a door opening). This area allows for placement of excess heating cable. Heating cables may also be installed 6" (150 mm) from the wall to create a buffer zone.
- Heating cable testing is required while the heating cable is on the spool and at two subsequent steps during installation to ensure cable quality and for warranty purposes.

Schluter®-DITRA-HEAT-E-HK-RK Heating Cable Repair Kit and Schluter®-DITRA-HEAT-E-HK-SK Heating Cable Splice Kit

Schluter®-DITRA-HEAT-E-HK-RK is a repair kit for DITRA-HEAT-E-HK heating cables. The kit contains all the material to replace one section of heating cable (gray section) up to 10" (25 cm) long or less in the event of damage, such as cuts by other trades during installation.

Schluter®-DITRA-HEAT-E-HK-SK is a splice kit for DITRA-HEAT-E-HK heating cables. The kit contains all the material to replace one factory splice of the heating cable.

Please visit www.schluter.com for ordering information.

WARNINGS

- Heating cable repairs must be conducted by a qualified electrician in accordance with this heating cable repair procedure,

the National Electric Code (USA) or Canadian Electric Code Part I (CAN) as applicable and the Schluter®-DITRA-HEAT Installation Handbook. All electrical connections must be made by a qualified electrician, according to the electrical and building codes effective in your region.

- **Prior to commencing a repair:** Any known deviations from the Schluter®-DITRA-HEAT Installation Handbook and/or applicable code(s) must be corrected. All cable installation and repair instructions must be followed in order to avoid personal injuries or property damage.
- Do not use these kits to splice different heating cables together. These kits are only intended for making repairs to a single cable.
- The heating cable cannot be shortened or altered to fit.

- **Very important:** Never CUT the heating cable. This could change the cable resistance and could lead to a fire.
- **WARRANTY DISCLAIMER:** Any deviation from the DITRA-HEAT Installation Handbook (which includes damage to the DITRA-HEAT-E-HK heating cables) voids the Schluter®-DITRA-HEAT Limited limited Warranty and warranty coverage is not reinstated upon repair of the heating cable. SCHLUTER SYSTEMS FURTHER DISCLAIMS ANY AND ALL WARRANTIES EXPRESSED OR IMPLIED, INCLUDING BUT NOT LIMITED TO THE IMPLIED WARRANTIES OF MERCHANTABILITY OR FITNESS FOR A PARTICULAR PURPOSE AND ANY AND ALL LIABILITY ARISING FROM THE ELECTRICIAN SERVICES.

Schluter®-DITRA-HEAT-E-KIT

Schluter®-DITRA-HEAT-E-KIT is an all-inclusive package containing the DITRA-HEAT uncoupling membrane, heating cable, and programmable thermostat.

Schluter®-DITRA-HEAT-E-KIT				
▲ Kit with Wi-Fi thermostat				
Item No.	Membrane	Heating cable	Thermostat	\$ / Kit
DHE K RT W 120 40	5 sheets – 43.1 ft ² (4.0 m ²)	26.7 ft ² (2.5 m ²)	1 – white, programmable Wi-Fi touchscreen	685.00
DHE K RT W 120 56	7 sheets – 60.3 ft ² (5.6 m ²)	37.5 ft ² (3.5 m ²)	1 – white, programmable Wi-Fi touchscreen	775.00

Kit with touchscreen programmable thermostat				
Item No.	Membrane	Heating cable	Thermostat	\$ / Kit
DHE K RT 120 40	5 sheets – 43.1 ft ² (4.0 m ²)	26.7 ft ² (2.5 m ²)	1 – white, programmable touchscreen	627.00
DHE K RT 120 56	7 sheets – 60.3 ft ² (5.6 m ²)	37.5 ft ² (3.5 m ²)	1 – white, programmable touchscreen	717.00





Schluter®-DITRA-HEAT-E Thermostats

Schluter®-DITRA-HEAT-E digital thermostats control the DITRA-HEAT-E-HK heating cables (both 120 V and 240 V). All thermostats feature a 5 mA built-in ground fault circuit interrupter (GFCI) with indicator light, and have an electrical current limit of 15 amps. A floor temperature sensor is included with each of the three available thermostats.

NEW! Schluter®-DITRA-HEAT-E-WiFi programmable Wi-Fi thermostat offers all the same features as the Programmable Touchscreen model, with additional Wi-Fi functionality that enables the user to control the DITRA-HEAT electric floor warming system from a mobile app or online.

Schluter®-DITRA-HEAT-E-RT programmable touchscreen thermostat features six programming periods per day, a set-up wizard, energy log, and a QR code for quick access to system settings.

Schluter®-DITRA-HEAT-E-R non-programmable version features simple on/off functionality.

▲ Schluter®-DITRA-HEAT-E-WiFi		
Touchscreen programmable Wi-Fi digital floor thermostat with remote sensor		
Item No.	Description	\$ / Unit
DHE RT 104/BW	Touchscreen programmable Wi-Fi thermostat in bright white with 1 floor temperature sensor	300.00

UL LISTED according to the following standards: UL 60730-1, UL 60730-2-9, CSA E60730-1, CSA E60730-2-9, UL E-file: E157297, GFCI: UL 943 4th ed., CSA C22.2 No. 144.1-06



Wi-Fi

Schluter®-DITRA-HEAT-E-RT		
Touchscreen programmable digital floor thermostat with remote sensor		
Item No.	Description	\$ / Unit
DHE RT 102/BW	Touchscreen programmable thermostat in bright white with 1 floor temperature sensor	240.00

UL LISTED according to the following standards: UL 60730, CSA E60730-1, UL E-file: E157297, GFCI: UL 943, CSA C22.2 No.144.1-06



RT

Schluter®-DITRA-HEAT-E-R		
Non-programmable digital floor thermostat with remote sensor		
Item No.	Description	\$ / Unit
DHE RT 103/BW	Non-programmable thermostat in bright white with 1 floor temperature sensor	165.00

UL LISTED according to the following standards: UL 60730, CSA E60730-1, UL E-file: E157297, GFCI: UL 943, CSA C22.2 No.144.1-06



R

Schluter®-DITRA-HEAT-E-RR

Schluter®-DITRA-HEAT-E-RR is a power module that extends power output when used in conjunction with the DITRA-HEAT-E-RT or DITRA-HEAT-E-R thermostats. The power module is designed to be used in large floor applications where the heating load exceeds 15 amps, in order to maintain a single point of control. Up to 16 DITRA-HEAT-E-RR power modules may be connected in series via low voltage signal wire to a single DITRA-HEAT-E-RT or DITRA-HEAT-E-R thermostat. The power module also features a 5 mA built-in GFCI.

Schluter®-DITRA-HEAT-E-RR		
Power module		
Item No.	Description	\$ / Unit
DHE RR 1/BW	Power module	155.00

UL LISTED according to the following standards: CSA E60730-1, GFCI: UL 943, CSA C22.2 No.144.1-06





Schluter®-Systems

SHOWER SYSTEM

Schluter®-Systems provides an integrated family of products in which the individual components collectively form a bonded watertight assembly. The Schluter®-Shower System eliminates the risk of failures due to both vapor and water penetration, is maintenance-free, and dramatically reduces total installation time.





Waterproofing



Waterproofing membranes provide protection—and peace-of-mind—behind your shower walls and other tiled elements subject to moisture. KERDI and KERDI-DS are pliable, sheet-applied, bonded waterproof membranes and vapor retarders with limited crack-bridging capabilities. Accessories made out of KERDI, including waterproofing strips, seamless corners, and pipe and mixing valve seals help complete the waterproofing process to ensure that your shower or bath surround is well-protected against mold and mildew.

Schluter®-KERDI and Schluter®-KERDI-DS

Schluter®-KERDI is a pliable sheet-applied polyethylene waterproofing membrane and vapor retarder that guarantees uniform thickness. It is covered with an anchoring fleece on both sides to anchor the membrane in thin-set mortar and is suitable for waterproofing in conjunction with tiled surfaces on walls and floors. KERDI is 8-mil thick and has a water vapor permeance of 0.90 perms, when tested according to ASTM E96, using Procedure E at 90% relative humidity.

Schluter®-KERDI-DS is a bonded waterproofing membrane and vapor retarder with very low water vapor permeance for use in continuous use steam rooms and similar applications. KERDI-DS is 20-mil thick and features additives to produce a water vapor permeance of 0.19 perms, when tested according to ASTM E96, using Procedure E at 90% relative humidity.

KERDI and KERDI-DS meet the American National Standard for Load Bearing, Bonded, Waterproof Membranes for Thin-Set Ceramic Tile and Dimension Stone Installations (ANSI A118.10). The membranes are listed by cUPC® and evaluated by ICC-ES (Report Nos. ESR-2467 and PMG-1204).

KERDI and KERDI-DS have been evaluated according to the "Standard Method for the Testing and Evaluation of Volatile Organic Chemical Emissions from Indoor Sources Using Environmental Chambers, Version 1.1" for California Specification 01350 and found to comply with the VOC requirements. California Specification 01350 is referenced by various green building standards and rating systems.

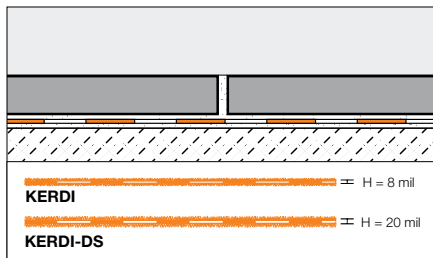

Note: 1 mil = 1 one-thousandth of an inch

Schluter®-KERDI			
Waterproofing membrane			
Item No.	Dimensions	\$ / ft ² *	\$ / Roll
Roll width: 1 m - 3' 3"			
KERDI 200/5M	1 m x 5 m = 5 m ² (3' 3" x 16' 5" = 54 ft ²)	2.25	121.50
KERDI 200/7M	1 m x 7 m = 7 m ² (3' 3" x 23' = 75 ft ²)	2.23	167.41
KERDI 200/10M	1 m x 10 m = 10 m ² (3' 3" x 33' = 108 ft ²)	2.21	238.68
KERDI 200/20M	1 m x 20 m = 20 m ² (3' 3" x 65' 7" = 215 ft ²)	2.08	447.20
KERDI 200	1 m x 30 m = 30 m ² (3' 3" x 98' 5" = 323 ft ²)	1.98	639.54
Roll width: 2 m - 6' 7"			
▲ KERDI 200200	2 m x 30 m = 60 m ² (6' 7" x 98' 5" = 646 ft ²)	1.98	1279.08

Schluter®-KERDI-DS			
Waterproofing membrane			
Item No.	Dimensions	\$ / ft ² *	\$ / Roll
KERDI-DS	1 m x 30 m = 30 m ² (3' 3" x 98' 5" = 323 ft ²)	2.35	759.05

* The price per square foot is for estimation purposes only. Please order using the price per roll.



**Schluter®-SET,
Schluter®-ALL-SET,
Schluter®-FAST-SET**
See page 152



Schluter®-KERDI-TROWEL
See page 154

Schluter®-KERDI-BAND

Schluter®-KERDI-BAND is a waterproofing strip used to seal butt joints and floor/wall connections with the Schluter®-KERDI, DITRA, and DITRA-HEAT membranes, as well as joints, corners, and fastener penetrations with the Schluter®-KERDI-BOARD building panels.

Note: 1 mil = 1 one-thousandth of an inch

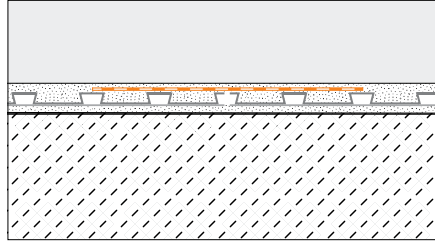

Schluter®-KERDI-BAND					
Waterproofing strip					
Item No.	Width	Length	Thickness	\$ / ft *	\$ / Roll
125 mm - 5" width					
KEBA 100/125/5M	125 mm - 5"	5 m - 16' 5"	4 mil	1.41	23.07
KEBA 100/125/10M	125 mm - 5"	10 m - 33'	4 mil	1.33	43.82
KEBA 100/125	125 mm - 5"	30 m - 98' 5"	4 mil	1.10	107.87
▲ KEBA100/125/300	125 mm - 5"	300 m - 984' 3"	4 mil	.99	970.83
185 mm - 7-1/4" width					
KEBA 100/185/5M	185 mm - 7-1/4"	5 m - 16' 5"	4 mil	1.84	30.19
KEBA 100/185	185 mm - 7-1/4"	30 m - 98' 5"	4 mil	1.52	149.87
250 mm - 10" width					
KEBA 100/250/5M	250 mm - 10"	5 m - 16' 5"	4 mil	2.25	36.97
KEBA 100/250	250 mm - 10"	30 m - 98' 5"	4 mil	1.96	192.82

* The price per foot is for estimation purposes only. Please order using the price per roll.

The **WIDE** Roll

- ✓ Fewer seams
- ✓ Faster installation
- ✓ Wide format covers wall area from floor to standard shower head height

See page 109

NEW!
6' 7" (2 m)
wide roll



Schluter®-KERDI-KERECK-F

Schluter®-KERDI-KERECK-F are preformed, seamless corners made of Schluter®-KERDI for waterproofing inside and outside corners.

Note: 1 mil = 1 one-thousandth of an inch

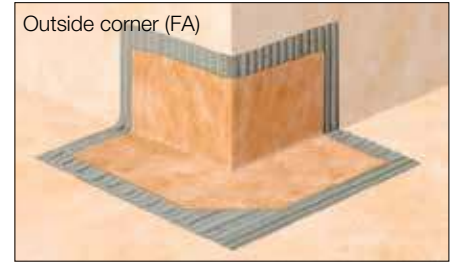

Schluter®-KERDI-KERECK-F			
Waterproofing for 90° corners			
Item No.	Thickness	Packaging	\$ / Package
KERECK/FI 2	4 mil	2 Inside corners	17.36
KERECK/FA 2	4 mil	2 Outside corners	17.36
Waterproofing for 135° corners			
KERECK 135 FI 2	4 mil	2 Inside corners	17.74

Schluter®-KERDI-KERECK-F			
Waterproofing for 90° corners			
Item No.	Thickness	Packaging	\$ / Package
KERECK/FI 10	4 mil	10 Inside corners	86.75
KERECK/FA 10	4 mil	10 Outside corners	86.75
Waterproofing for 135° corners			
KERECK 135 FI 10	4 mil	10 Inside corners	87.80

Schluter®-KERDI-KERS-B

Schluter®-KERDI-KERS-B are preformed, seamless corners for waterproofing 135° angles between triangular shower benches and walls or the tops of curbs in neo-angle shower applications.

Note: 1 mil = 1 one-thousandth of an inch

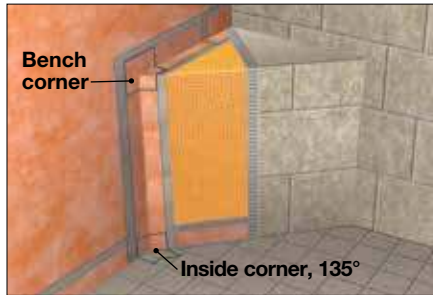

Schluter®-KERDI-KERS-B				
Waterproofing corners				
Item No.	Thickness	Description	Packaging	\$ / Package
KERECK 135 FI 2	4 mil	Inside corner, 135°	2 units	17.74
KERECK 135 FI 10	4 mil	Inside corner, 135°	10 units	87.80
KERSB 135 K LR	4 mil	Bench corners	1 right and 1 left	37.29
KERSB 135 K 5LR	4 mil	Bench corners	5 right and 5 left	177.13
KERSB 135 K	4 mil	Bench/ neo-angle corner kit	1 right and 1 left bench corner, and 2 135° inside corners	55.03

Schluter®-KERDI-KERS

Schluter®-KERDI-KERS are preformed, seamless corners made of Schluter®-KERDI for waterproofing floor/wall/shower base connections in curbless shower applications where the Schluter®-KERDI-LINE linear drain is installed adjacent to the wall.

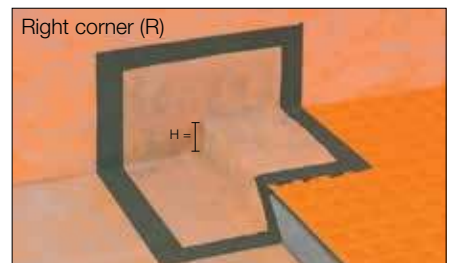
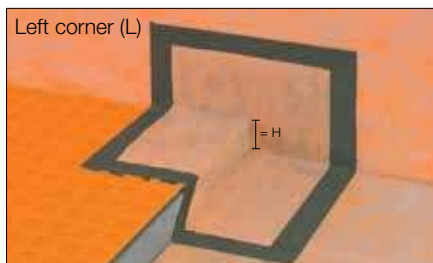

Schluter®-KERDI-KERS				
Waterproofing for corners				
Item No.	H = mm - in.	Thickness	Description	\$ / Unit
KERS 20 L	20 - 3/4	4 mil	Left inside corner	20.60
KERS 28 L	28 - 1-3/32	4 mil	Left inside corner	20.60
KERS 20 R	20 - 3/4	4 mil	Right inside corner	20.60
KERS 28 R	28 - 1-3/32	4 mil	Right inside corner	20.60

Schluter®-KERDI-SEAL-PS/-MV

Schluter®-KERDI-SEAL-PS/-MV pre-fabricated seals are cut sections of the Schluter®-KERDI waterproofing membrane designed to seal protrusions through the Schluter®-KERDI or Schluter®-DITRA/DITRA-XL as well as Schluter®-KERDI-BOARD building panels. Schluter®-KERDI-SEAL-PS and -MV feature overmolded rubber gaskets and are used to seal pipe protrusions and protect moisture-sensitive solid backing panels at the mixing valve.

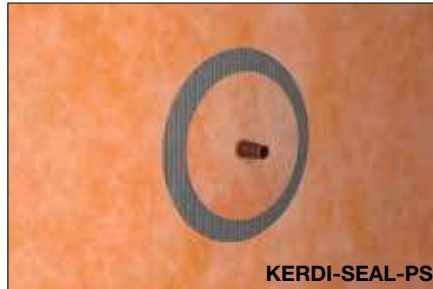

KERDI-SEAL-PS



KERDI-SEAL-MV

Note: 1 mil = 1 one-thousandth of an inch

Schluter®-KERDI-SEAL-PS

Pipe seal with overmolded rubber gasket

Item No.	Pipe nipple opening diam.	Thickness	Packaging	\$ / Package
KMS185/12	1/2" - 12.5 mm	4 mil	1 unit	7.48
KMS185/20	3/4" - 20 mm	4 mil	1 unit	7.48
KMS10185/12	1/2" - 12.5 mm	4 mil	10 units	67.32
KMS10185/20	3/4" - 20 mm	4 mil	10 units	67.32

Schluter®-KERDI-SEAL-MV

Mixing valve seal with overmolded rubber gasket

Item No.	Mixing valve opening diam.	Thickness	Packaging	\$ / Package
KMSMV235/114	4-1/2" - 114 mm	4 mil	1 unit	8.63
KMSMV10235/114	4-1/2" - 114 mm	4 mil	10 units	77.67

Schluter®-KERDI-KM

Schluter®-KERDI-KM prefabricated seal is cut sections of the Schluter®-KERDI waterproofing membrane designed to seal protrusions through the KERDI or Schluter®-DITRA/DITRA-XL membranes. KERDI-KM is designed to be used in conjunction with Schluter®-KERDI-FIX or equivalent sealant to seal around pipes or other similar elements.



Schluter®-KERDI-KM

Pipe seal

Item No.	Pipe nipple opening diam.	Thickness	Packaging	\$ / Package
KM5117/22	7/8" - 22 mm	4 mil	5 units	10.66



KERDI-DRAIN



The classically-inspired Schluter®-KERDI-DRAIN is available with a variety of grate finishes, and accommodates a wide range of tile thicknesses.



Schluter®-KERDI-DRAIN-STYLE

New 4" brushed stainless steel designer drain grates



Curve

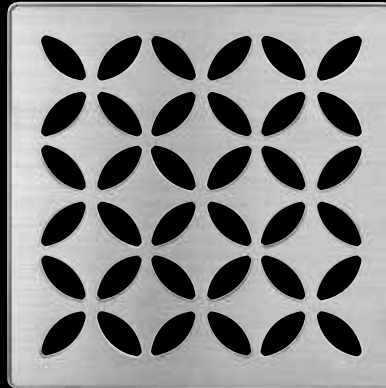

Floral

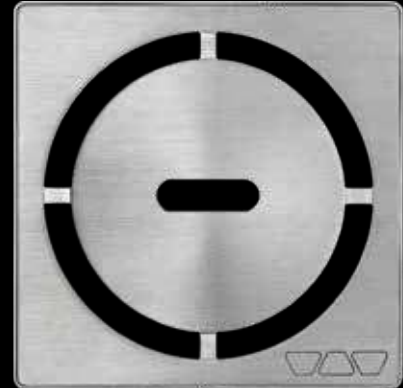

Pure



Stainless steel



Chrome



Oil-rubbed bronze



Tileable covering support



Brushed nickel anodized aluminum



Brushed copper anodized aluminum



Brushed brass anodized aluminum



Schluter®-KERDI-DRAIN and Schluter®-KERDI-DRAIN-H

Schluter®-KERDI-DRAIN and **Schluter®-KERDI-DRAIN-H** are floor drains with an integrated bonding flange that provides a large contact area for a secure connection to the Schluter®-KERDI waterproofing membrane at the top of the assembly. Both KERDI-DRAIN and KERDI-DRAIN-H are appropriate for both mortar bed and Schluter®-KERDI-SHOWER-T/-TS/-TT shower tray applications. The bonding flange is sloped to simplify installation of the mortar bed.

The KERDI-DRAIN flange provides a vertical connection to the drain pipe and is available in ABS or PVC with 2" or 3" outlet, and stainless steel with a 2" or 3" no-hub outlet or 2" threaded outlet.

The KERDI-DRAIN-H flange provides a horizontal connection to the drain pipe and is available in ABS or PVC with a 2" outlet. It is ideal for applications where the use of a vertical connection to the drain pipe is not possible or practical (e.g., suspended or post-tension concrete floors, basement slabs, or wood floor installations where relocating the hole in the floor is not practical). The horizontal outlet allows the positioning of the drain in the desired area regardless of drain pipe location.

A compensation board is available for use with KERDI-DRAIN-H in conjunction the KERDI-SHOWER-T/-TS/-TT shower trays.

KERDI-DRAIN and KERDI-DRAIN-H feature a fully adjustable grate (available in stainless steel and anodized aluminum in various finishes) that accommodates a wide range of tile thicknesses: 1/4" (6 mm) to 1-1/4" (32 mm); or a tileable covering support that accommodates any tile thickness and creates a virtually invisible drainage line. The grate assembly allows lateral and tilt adjustment as well. Please note that grate assemblies used with the plastic KERDI-DRAIN featuring 3" outlets only allow vertical and tilt adjustment (no lateral adjustment). 6" -square stainless steel covers are also available for installations where KERDI-DRAIN or KERDI-DRAIN-H are to be used in a cleanout application.

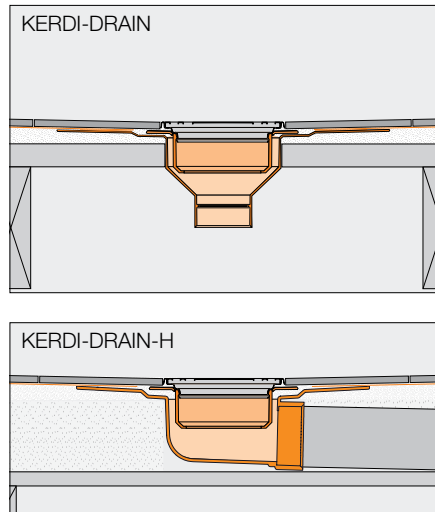



Ordering your Schluter®-KERDI-DRAIN

Schluter®-KERDI-DRAIN flanges and grates are sold separately.

1 Select the flange appropriate for your application from the tables on pages 116-119.

2 Select your grate from pages 120-121.

Note: When using a flange with a 3" outlet, a 6" grate is recommended. When using the flange with 5-1/4" adaptor ring, the 4" tileable grate and 6" round and square grates are not suitable. Refer to the table below to verify the compatibility of your selected flange/grate combination.

Schluter®-KERDI-DRAIN - Suitable Flange and Grate Combinations													
Grates	Grate - 4" (100 mm)										Grate - 6" (150 mm)		
	Stainless steel				Anodized aluminum			STYLE - Brushed stainless steel			Stainless steel		
	Stainless steel E	Chrome EP	Bronze EOB	Tileable ECS	Copper AKGB	Brass AMGB	Nickel ATGB	Pure	Curve	Floral	Square 6E	Round 6RE	Cover 6CE
2" PVC	✓	✓	✓	✓	✓	✓	✓	✓	✓	✓	✓	✓	✓
2" ABS	✓	✓	✓	✓	✓	✓	✓	✓	✓	✓	✓	✓	✓
2" PVC Horizontal	✓	✓	✓	✓	✓	✓	✓	✓	✓	✓	✓	✓	✓
2" ABS Horizontal	✓	✓	✓	✓	✓	✓	✓	✓	✓	✓	✓	✓	✓
2" Stainless steel	✓	✓	✓	✓	✓	✓	✓	✓	✓	✓	✓	✓	✓
2" Stainless steel Threaded	✓	✓	✓	✓	✓	✓	✓	✓	✓	✓	✓	✓	✓
3" PVC											✓	✓	✓
3" ABS											✓	✓	✓
3" Stainless steel											✓	✓	✓
5-1/4" Adaptor	✓	✓	✓		✓	✓	✓	✓	✓	✓			
7-1/2" Adaptor	✓	✓	✓	✓	✓	✓	✓	✓	✓	✓	✓	✓	✓

Schluter®-KERDI-DRAIN - Listings and Certifications													
Grates	Grate - 4" (100 mm)										Grate - 6" (150 mm)		
	Stainless steel				Anodized aluminum			STYLE Brushed stainless steel			Stainless steel		
	Stainless steel E	Chrome EP	Bronze EOB	Tileable ECS	Copper AKGB	Brass AMGB	Nickel ATGB	Pure	Curve	Floral	Square 6E	Round 6RE	Cover 6CE
2" PVC	1	1	-	1	1	1	1	1	1	1	1	1	2
2" ABS	1	1	-	1	1	1	1	1	1	1	1	1	2
2" PVC Horizontal	3	3	-	3	3	3	3	3	3	3	3	3	3
2" ABS Horizontal	3	3	-	3	3	3	3	3	3	3	3	3	3
2" Stainless steel	1	1	-	1	1	1	1	1	1	1	1	1	2
2" Stainless steel Threaded	1	1	-	1	1	1	1	1	1	1	1	1	2
3" PVC	-	-	-	-	-	-	-	-	-	-	1	1	2
3" ABS	-	-	-	-	-	-	-	-	-	-	1	1	2
3" Stainless steel	-	-	-	-	-	-	-	-	-	-	1	1	2
5-1/4" Adaptor	-	-	-	-	-	-	-	-	-	-	-	-	-
7-1/2" Adaptor	-	-	-	-	-	-	-	-	-	-	-	-	-

Various configurations of KERDI-DRAIN are listed by ICC-ES (Report No. PMG-1204), UPC® and CSA as shown in the table above.

1 - Listed by ICC-ES (Report No. PMG-1204), UPC® and CSA.

2 - Listed by CSA



3 - CSA, UPC, and ICC-ES listings in progress, please check www.schluter.ca for the most up-to-date information.



For copies of these documents, please contact Schluter®-Systems at 800-667-8746 or by email at info@schluter.com. Links to the documents can also be accessed at www.schluter.ca.



Schluter®-KERDI-DRAIN

ABS or PVC FLANGE – 2" or 3" OUTLET

2" (50 mm) drain outlet		
Material	Item No.	\$ / Unit
 ABS	KD2 FLK ABS	74.88
 PVC	KD2 FLK PVC	74.88

3" (75 mm) drain outlet		
Material	Item No.	\$ / Unit
 ABS	KD3 FLK ABS	84.12
 PVC	KD3 FLK PVC	84.12

Additional components included



4x
Inside corners



2x
Outside corners



1x
Pipe seal
(3/4" - 20 mm)

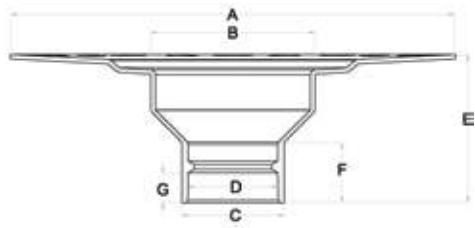

1x
Mixing valve seal
(4-1/2" - 114 mm)

Flange measurements			
ABS or PVC			
	2" (50 mm) drain outlet	3" (75 mm) drain outlet	
	A	11-13/16" - 300 mm	11-13/16" - 300 mm
	B	4-17/32" - 115.2 mm	4-17/32" - 115.2 mm
	C	2-45/64" - 68.6 mm	3-15/16" - 100 mm
	D	2-3/8" - 60.5 mm	3-1/2" - 88.8 mm
	E	3-15/16" - 100 mm	3-15/16" - 100 mm
	F	1-39/64" - 40.6 mm	2" - 50.8 mm
	G	7/8" - 22.5 mm	1-1/2" - 38.1 mm

KERDI-DRAIN Grates sold separately
See pages 120-121





i

When using a flange with 3" outlet, a 6" grate is recommended.







Schluter®-KERDI-DRAIN

STAINLESS STEEL FLANGE – 2" or 3" OUTLET

2" (50 mm) drain outlet		
Material	Item No.	\$ / Unit
 No-hub	KD2 FLK E	208.03
 Threaded	KD2 FLK ETH	239.28

3" (75 mm) drain outlet		
Material	Item No.	\$ / Unit
 No-hub	KD3 FLK E	208.03

Additional components included

 **4x** Inside corners
  **2x** Outside corners
  **1x** Pipe seal (3/4" - 20 mm)
  **1x** Mixing valve seal (4-1/2" - 114 mm)
  **1x** KERDI-FIX sealing and bonding compound (3.38 oz - 100 ml)

Flange measurements

Stainless steel

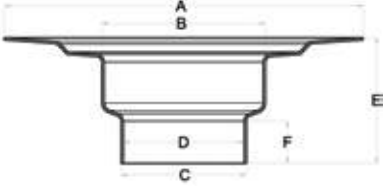
	2" (50 mm) no-hub outlet		3" (75 mm) no-hub outlet	
	A	B	C	D
	9-27/32" - 250 mm	9-27/32" - 250 mm	9-27/32" - 250 mm	9-27/32" - 250 mm
	4-1/2" - 115.4 mm	4-1/2" - 114 mm	4-1/2" - 115.4 mm	4-1/2" - 114 mm
	2-13/32" - 61.3 mm	3-7/16" - 87.4 mm	2-13/32" - 61.3 mm	3-7/16" - 87.4 mm
	2-13/32" - 60.6 mm	3-5/16" - 84.2 mm	2-13/32" - 60.6 mm	3-5/16" - 84.2 mm
	3-11/32" - 85 mm	3-7/16" - 87.4 mm	3-11/32" - 85 mm	3-7/16" - 87.4 mm
	53/64" - 21 mm	1-5/32" - 29.4 mm	53/64" - 21 mm	1-5/32" - 29.4 mm

KERDI-DRAIN Grates sold separately
See pages 120-121





i

When using a flange with 3" outlet, a 6" grate is recommended.

Schluter®-KERDI-DRAIN-H

ABS or PVC FLANGE — 2" OUTLET HORIZONTAL

2" (50 mm) drain outlet		
Material	Item No.	\$ / Unit
 ABS	KDH2 FLK ABS	74.88
 PVC	KDH2 FLK PVC	74.88

Additional components included

 4x Inside corners	 2x Outside corners	 1x Pipe seal (3/4" - 20 mm)	 1x Mixing valve seal (4-1/2" - 114 mm)
---	--	---	--

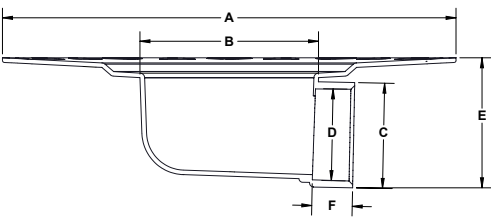
Flange measurements		
ABS or PVC		
	2" (50 mm) horizontal drain outlet	
	A	11-13/16" - 300 mm
	B	4-21/32" - 118.3 mm
	C	2-47/64" - 69.5 mm
	D	2-3/8" - 60.5 mm
	E	3-3/8" - 85.7 mm
	F	1-1/16" - 27 mm

KERDI-DRAIN Grates sold separately
See pages 120-121



Schluter®-KERDI-SHOWER-CB

Schluter®-KERDI-SHOWER-CB is a height compensation board made of lightweight expanded polystyrene used to accommodate the drain body and waste pipe height, when installing the Schluter®-KERDI-DRAIN-H in conjunction with the Schluter®-KERDI-SHOWER-T/TS/TT shower trays. The compensation board can easily be cut to size to fit around the drain and waste pipe, and multiple boards can be used to fit the size and shape of the shower.

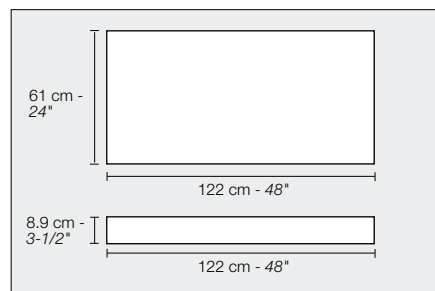

Schluter®-KERDI-SHOWER-CB		
Compensation board		
Item No.	Dimensions	\$ / Unit
KSCB 90 610 1220	122 cm x 61 cm x 8.9 cm (48" x 24" x 3-1/2")	92.50



Schluter®-KERDI-DRAIN-A

ADAPTOR KIT — 5-1/4" or 7-1/2" ADAPTOR RING

Schluter®-KERDI-DRAIN ADAPTOR KITS are used to convert traditional clamping ring drains to integrated bonding flange drains when removal of the clamping ring drain is not practical. A stainless steel adaptor ring with an overmolded rubber gasket replaces the clamping ring and is sealed to the existing drain body using Schluter®-KERDI-FIX. The bonding flange then slides into the adaptor ring and seals against the rubber gasket. Adaptor kits are suitable for both mortar bed and Schluter®-KERDI-SHOWER-T/-TS/-TT shower tray applications.

5-1/4" (133.4 mm) adaptor ring		
Flange and ring	Item No.	\$ / Unit
<p>5-1/4"</p> <p>Also included: Height adjustment collar for KERDI-DRAIN grate</p>	KDA5 FLK ABS	74.88

7-1/2" (191 mm) adaptor ring		
Flange and ring	Item No.	\$ / Unit
<p>7-1/2"</p> <p>Also included: Lateral adjustment ring for KERDI-DRAIN grate</p>	KDA7 FLK ABS	92.94

Additional components included

4x Inside corners
 2x Outside corners
 1x Pipe seal (3/4" - 20 mm)
 1x Mixing valve seal (4-1/2" - 114 mm)
 1x KERDI-FIX sealing and bonding compound (3.38 oz - 100 ml)

Flange and adaptor ring measurements	
ABS	
	5-1/4"
	A 11-13/16" - 300 mm
	B 2-13/32" - 60.7 mm
	C 2-23/32" - 69.3 mm
	D 5-1/4" - 133.4 mm
	E 2-29/32" - 74 mm
	F 1-1/64" - 25.9 mm
	G 2-1/16" - 52.6 mm

Flange and adaptor ring measurements	
ABS	
	7-1/2"
	A 11-13/16" - 300 mm
	B 4-13/32" - 111.8 mm
	C 4-11/16" - 118.9 mm
	D 7-1/2" - 191 mm
	E 5-7/64" - 130 mm
	F 3-1/16" - 77.8 mm
	G 3-41/64" - 92.4 mm

KERDI-DRAIN Grates sold separately
See pages 120-121



The tileable grate and the 6" round/square grates are **NOT** compatible with the 5-1/4" ring flange.

Schluter®-KERDI-DRAIN

GRATES FOR USE WITH FLANGES WITH 2" OUTLET

4" (100 mm) Grate

NEW! Schluter®-KERDI-DRAIN-STYLE



Brushed stainless steel	
Item No.	\$ / Unit
▲ KDIF4 GRK EBD6	70.13

U.S. Patent No. D831,171

Brushed stainless steel	
Item No.	\$ / Unit
▲ KDIF4 GRK EBD5	70.13

U.S. Patent No. D831,172

Brushed stainless steel	
Item No.	\$ / Unit
▲ KDIF4 GRK EBD8	70.13

U.S. Patent No. D831,795

Stainless steel



Stainless steel	
Item No.	\$ / Unit
KD4 GRK E	54.46

Chrome	
Item No.	\$ / Unit
KD4 GRK EP	54.46

Oil-rubbed bronze	
Item No.	\$ / Unit
KD4 GRK EOB	65.80

Anodized aluminum



Brushed nickel anodized aluminum	
Item No.	\$ / Unit
KD4 GRK ATGB	65.80

Brushed copper anodized aluminum	
Item No.	\$ / Unit
KD4 GRK AKGB	65.80

Brushed brass anodized aluminum	
Item No.	\$ / Unit
KD4 GRK AMGB	65.80

Contents



1x
Grate and frame



1x
Height adjustment collar



1x
Lateral adjustment ring



Schluter®-KERDI-DRAIN

GRATES FOR USE WITH FLANGES WITH 2" OUTLET

4" (100 mm) Grate

Tileable grate



Tileable grate	
Item No.	\$ / Unit
KD4 GRK ECS	54.46

Patent pending

Contents					
	<p>1x Tileable covering support</p>		<p>1x Spacer</p>		<p>1x Lateral adjustment ring</p>

GRATES FOR USE WITH FLANGES WITH 2" or 3" OUTLET

6" (150 mm) Grate



Stainless steel



Stainless steel - 6" square	
Item No.	\$ / Unit
KD6 GRK E	63.38



Stainless steel - 6" round	
Item No.	\$ / Unit
KD6 GRK RE	63.38

Contents			
	<p>1x Grate and frame with integrated height adjustment collar</p>		<p>1x Lateral adjustment ring</p>











Schluter®-KERDI-DRAIN

DRAIN KITS — ABS or PVC FLANGE - 2" OUTLET - STAINLESS STEEL GRATE

Schluter®-KERDI-DRAIN			
	ABS - 2" (50 mm)	PVC - 2" (50 mm)	\$ / Unit
4" (100 mm) square grate			
Stainless steel	KD2/ABS/E	KD2/PVC/E	129.34









Contents

	1x Flange		1x Grate and frame		1x Height adjustment collar		1x Lateral adjustment ring
	4x Inside corners		2x Outside corners		1x Pipe seal (3/4" - 20 mm)		1x Mixing valve seal (4-1/2" - 114 mm)

ADAPTOR KIT — 5-1/4" ADAPTOR RING - 4" STAINLESS STEEL GRATE

5-1/4" (133.4 mm) adaptor ring		
	ABS	\$ / Unit
4" (100 mm) square grate		
Stainless steel	KDAR/ABS/E	129.34



Contents



	1x Flange		1x Grate and frame		1x Height adjustment collar		1x Adaptor ring
	4x Inside corners		2x Outside corners		1x Pipe seal (3/4" - 20 mm)		1x Mixing valve seal (4-1/2" - 114 mm)
	1x KERDI-FIX sealing and bonding compound (3.38 oz - 100 ml)						





Schluter®-KERDI-DRAIN

ABS or PVC FLANGE — 2" or 3" OUTLET - WITHOUT SEALS AND CORNERS



2" (50 mm) drain outlet		
Material	Item No.	\$ / Unit
 ABS	KD2/ABS/FL	26.45
 PVC	KD2/PVC/FL	26.45

3" (75 mm) drain outlet		
Material	Item No.	\$ / Unit
 ABS	KD3/ABS/FL	35.69
 PVC	KD3/PVC/FL	35.69

ABS or PVC HORIZONTAL FLANGE — 2" OUTLET - WITHOUT SEALS AND CORNERS

2" (50 mm) drain outlet		
Material	Item No.	\$ / Unit
 ABS	KDH2/ABS/FL	26.45
 PVC	KDH2/PVC/FL	26.45

STAINLESS STEEL FLANGE — 2" or 3" OUTLET - WITHOUT SEALS AND CORNERS

2" (50 mm) drain outlet		
Material	Item No.	\$ / Unit
 No-hub	KD2/E/FL	169.60
 Threaded	KD2/ETH/FL	182.50

3" (75 mm) drain outlet		
Material	Item No.	\$ / Unit
 No-hub	KD3/E/FL	169.60

Also included with stainless steel flanges

1x
KERDI-FIX
sealing and bonding compound (3.38 oz – 100 ml)



KERDI-DRAIN Grates sold separately
See pages 120-121









When using a flange with 3" outlet, a 6" grate is recommended.



Schluter®-KERDI-DRAIN

10 PACKS — ABS OR PVC FLANGE - 2" OUTLET





2" (50 mm) drain outlet		
Material	Item No.	\$ / 10 Units
 ABS	KD2 FLK ABS 10	673.92
 PVC	KD2 FLK PVC 10	673.92

Additional components included	
 40x Inside corners	 20x Outside corners
 10x Pipe seal (3/4" - 20 mm)	 10x Mixing valve seal (4-1/2" - 114 mm)

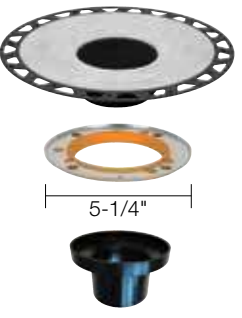
Note: 10 packs are packaged in bulk, not individually boxed.

10 PACKS — ABS FLANGE - 5-1/4" ADAPTOR RING

5-1/4" (133.4 mm) adaptor ring		
Flange and ring	Item No.	\$ / 10 Units
 5-1/4" Also included: Height adjustment collar for KERDI-DRAIN grate	KDA5 FLK ABS 10	673.92

Additional components included	
 40x Inside corners	 20x Outside corners
 10x Pipe seal (3/4" - 20 mm)	 10x Mixing valve seal (4-1/2" - 114 mm)
 10x KERDI-FIX sealing and bonding compound (3.38 oz - 100 ml)	

Note: 10 packs are packaged in bulk, not individually boxed.





The tileable grate and the 6" round/square grates are **NOT** compatible with the 5-1/4" ring flange.

10 PACKS — 4" GRATE - STAINLESS STEEL

Stainless steel



Stainless steel	
Item No.	\$ / 10 Units
KD4 GRK E 10	490.14

Contents	
 10x Grate and frame	 10x Height adjustment collar
 10x Lateral adjustment ring	

Note: 10 packs are packaged in bulk, not individually boxed.



Schluter®-KERDI-DRAIN

6" SQUARE CLEAN OUT COVER

The **Schluter®-KERDI-DRAIN Clean Out Cover** is a 6" stainless steel cover available for installations where the KERDI-DRAIN bonding flange is to be used in a cleanout application.



Clean out cover 6"		
Item No.	Finish	\$ / Unit
KD-GR6C-E	Stainless steel	143.35

TAMPER PROOF SCREWS

Schluter®-KERDI-DRAIN Tamper Proof Screws are designed as a high security accessory for the KERDI-DRAIN. Ideal for loss prevention and anti-theft, these tamper proof screws are used in environments where tamper resistance is desired or required (e.g., healthcare or education facilities, etc.). Phillips head screws are included with the KERDI-DRAIN. The tamper-proof screws as well as the driver bit must be purchased separately.



Tamper proof screw and driver bit		
Item No.	Description	\$ / Unit
KD/TPSCRW	Tamper proof screw	2.70
KD/TPWRCH	Driver bit	13.10

▲ STRAINER

The **Schluter®-KERDI-DRAIN Strainer** is a hair catcher customized to fit inside the KERDI-DRAIN flange to trap and collect hair. Simple to remove and clean, the hair catcher fits discreetly into the drain to prevent hair clogs that can lead to blocked pipes.



Strainer for KERDI-DRAIN		
Item No.	Description	\$ / Unit
KD-STR	Strainer	2.75



KERDI-LINE

The Schluter®-KERDI-LINE low-profile linear drain takes your tiled shower to the next level—and is the ideal drain for barrier-free bathrooms. KERDI-LINE is available with several grate designs, including a frameless tileable covering support, which virtually disappears in the field tile.



Schluter®-KERDI-LINE-STYLE

New brushed stainless steel designer drain grates

Pure



Floral



Curve



Schluter®-KERDI-LINE

An elegant low-profile linear floor drain

- ✓ Available in multiple lengths
- ✓ Stainless steel channel body
- ✓ Installation adjacent to walls or at intermediate locations
- ✓ Floors can be sloped on single plane, enabling use of large-format tile
- ✓ Suitable for wheelchair accessible showers





Schluter®-KERDI-LINE

The Schluter®-KERDI-LINE is a low profile linear floor drain specifically designed for bonded waterproofing assemblies. KERDI-LINE can be installed adjacent to walls or at intermediate locations in showers, wet rooms, and other applications that require waterproofing and drainage. The floor can be sloped on a single plane to KERDI-LINE, which enables the use of large-format tiles and creates interesting design opportunities.

The KERDI-LINE channel body is made of formed stainless steel and features a collar made of Schluter®-KERDI for a secure waterproof connection. The grate assembly is available in six design options:

- A - closed-design
- B - perforated
- D - frameless, tileable covering support
- E - Floral
- F - Curve
- G - Pure

If KERDI-LINE is placed at shower entrance, it is recommended that grate assembly A or D is chosen and that the drainage openings span the maximum width of the entrance to limit potential overflow; secondary drainage (e.g., KERDI-DRAIN) may be required in the drying area.

Grate and frame assemblies A and B are available in brushed stainless steel, or stainless steel with chrome finish, and can be adjusted for use with tile coverings from 1/8" to 1" (3 mm to 25 mm) -thick. The tileable covering support can accommodate any thickness of tile covering. Grate and frame assemblies E, F and G (KERDI-LINE-STYLE) are available in brushed stainless steel and can accommodate tile coverings from 1/4" to 11/16" (6 - 18 mm) -thick.

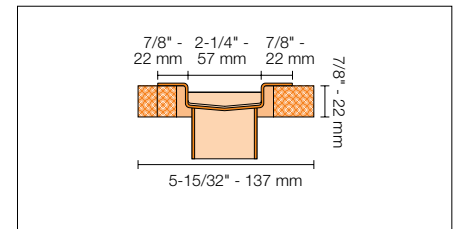
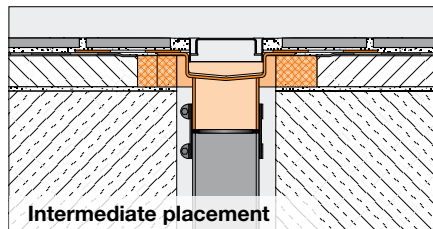
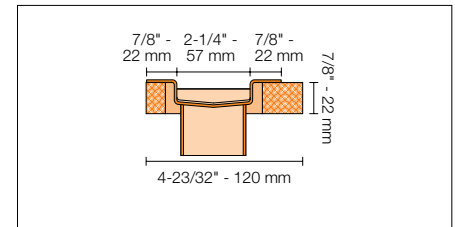
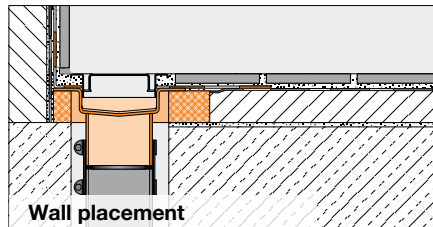
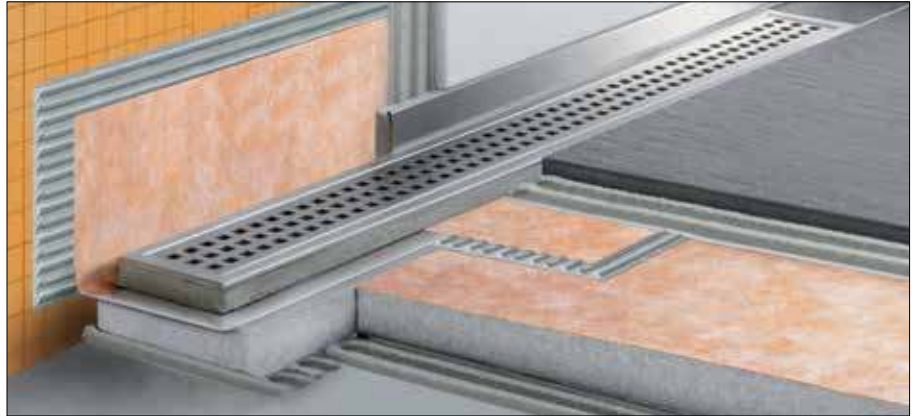

There are multiple selections to be made for this product. Begin by selecting the appropriate channel body length then proceed to grate selection accordingly, keeping in mind there two frame height options for the perforated and closed-design grates.

Schluter®-KERDI-LINE – Listings and Certifications

Channel body	Grate	Closed (A)	Perforated (B)	Tileable (D)	Floral (E)	Curve (F)	Pure (G)
Center outlet - 19-11/16" - 47-1/4" (50 cm - 120 cm)		1	1	1	1	1	1
Center outlet - 51-3/16" - 70-13/16" (130 cm - 180 cm)		1	1	1	1	1	1
Off-set outlet - 27-9/16" - 47-1/4" (70 cm - 120 cm)		1	1	1	1	1	1

Various configurations of KERDI-LINE are listed by ICC-ES (Report No. PMG-1204), UPC®, and CSA as shown in the table above.
 1 - Listed by ICC-ES (Report No. PMG-1204), UPC®, and CSA.

For copies of these documents, please contact Schluter®-Systems at 800-667-8746 or by email at info@schluter.com. Links to the documents can also be accessed at www.schluter.ca.



Schluter®-KERDI-LINE

CHANNEL BODY

Contents



1x
Channel body



1x
Channel support



1x
No-hub coupling



4x
Inside corners



2x
Outside corners



1x
Pipe seal
(3/4" - 20 mm)



1x
Mixing valve seal
(4-1/2" - 114 mm)

Channel body center outlet

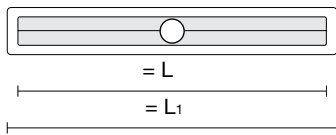

Schluter®-KERDI-LINE

Channel body - stainless steel - center outlet

$L =$ in. - cm	$L_1 =$ in. - cm	Item No.	Retail price
19-11/16 - 50	21-11/16 - 55	KL1V 60 E 50	301.00
23-5/8 - 60	25-5/8 - 65	KL1V 60 E 60	310.55
27-9/16 - 70	29-9/16 - 75	KL1V 60 E 70	337.32
31-1/2 - 80	33-1/2 - 85	KL1V 60 E 80	340.58
35-7/16 - 90	37-7/16 - 95	KL1V 60 E 90	355.70
39-3/8 - 100	41-3/8 - 105	KL1V 60 E 100	365.62
43-5/16 - 110	45-5/16 - 115	KL1V 60 E 110	373.25
47-1/4 - 120	49-1/4 - 125	KL1V 60 E 120	390.64
51-3/16 - 130	53-3/16 - 135	KL1V 60 E 130	473.38
55-1/8 - 140	57-1/8 - 145	KL1V 60 E 140	485.40
59-1/16 - 150	61-1/16 - 155	KL1V 60 E 150	497.02
62-15/16 - 160	64-15/16 - 165	KL1V 60 E 160	506.65
66-7/8 - 170	68-7/8 - 175	KL1V 60 E 170	514.56
70-13/16 - 180	72-13/16 - 185	KL1V 60 E 180	523.47

Channel body off-set outlet

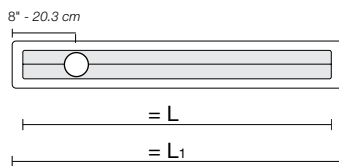

Channel body - stainless steel - off-set outlet

$L =$ in. - cm	$L_1 =$ in. - cm	Item No.	Retail price
27-9/16 - 70	29-9/16 - 75	KL1VO 60 E 70	341.47
31-1/2 - 80	33-1/2 - 85	KL1VO 60 E 80	344.78
35-7/16 - 90	37-7/16 - 95	KL1VO 60 E 90	360.56
39-3/8 - 100	41-3/8 - 105	KL1VO 60 E 100	383.82
43-5/16 - 110	45-5/16 - 115	KL1VO 60 E 110	399.38
47-1/4 - 120	49-1/4 - 125	KL1VO 60 E 120	418.34



Schluter®-KERDI-LINE

GRATE ASSEMBLY - BRUSHED STAINLESS STEEL

CONTENTS

1x
Grate
6 design options:

- Closed-design
- Perforated
- Frameless tileable
- Curve
- Floral
- Pure

1x
Grate frame with height adjustment spacers.
See product tables for frame height options (not included with frameless tileable grate).



Closed (A)

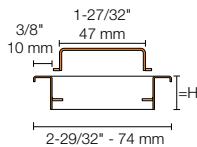

Perforated (B)

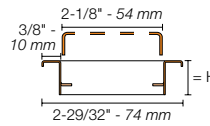

Grate assemblies - Brushed stainless steel

Length = in. - cm	Closed (A)		Perforated (B)	
	Item No.	Retail price	Item No.	Retail price
3/4" (19 mm) frame height for 1/8" to 9/16" (3 mm to 15 mm) -thick coverings				
19-11/16 - 50	KL1AR 19 EB 50	279.83	KL1B 19 EB 50	254.65
23-5/8 - 60	KL1AR 19 EB 60	287.84	KL1B 19 EB 60	259.51
27-9/16 - 70	KL1AR 19 EB 70	299.67	KL1B 19 EB 70	273.85
31-1/2 - 80	KL1AR 19 EB 80	307.42	KL1B 19 EB 80	278.83
35-7/16 - 90	KL1AR 19 EB 90	321.87	KL1B 19 EB 90	294.01
39-3/8 - 100	KL1AR 19 EB 100	341.13	KL1B 19 EB 100	302.50
43-5/16 - 110	KL1AR 19 EB 110	349.50	KL1B 19 EB 110	313.33
47-1/4 - 120	KL1AR 19 EB 120	355.83	KL1B 19 EB 120	319.28
51-3/16 - 130	KL1AR 19 EB 130	463.92	KL1B 19 EB 130	463.92
55-1/8 - 140	KL1AR 19 EB 140	487.17	KL1B 19 EB 140	487.17
59-1/16 - 150	KL1AR 19 EB 150	512.70	KL1B 19 EB 150	512.70
62-15/16 - 160	KL1AR 19 EB 160	545.86	KL1B 19 EB 160	545.86
66-7/8 - 170	KL1AR 19 EB 170	569.10	KL1B 19 EB 170	569.10
70-13/16 - 180	KL1AR 19 EB 180	601.70	KL1B 19 EB 180	601.70
1-1/8" (30 mm) frame height for 1/2" to 1" (13 mm to 25 mm) -thick coverings				
19-11/16 - 50	KL1AR 30 EB 50	287.89	KL1B 30 EB 50	261.98
23-5/8 - 60	KL1AR 30 EB 60	297.72	KL1B 30 EB 60	268.41
27-9/16 - 70	KL1AR 30 EB 70	311.32	KL1B 30 EB 70	284.49
31-1/2 - 80	KL1AR 30 EB 80	320.23	KL1B 30 EB 80	290.43
35-7/16 - 90	KL1AR 30 EB 90	337.42	KL1B 30 EB 90	308.22
39-3/8 - 100	KL1AR 30 EB 100	358.41	KL1B 30 EB 100	317.82
43-5/16 - 110	KL1AR 30 EB 110	367.86	KL1B 30 EB 110	329.79
47-1/4 - 120	KL1AR 30 EB 120	374.17	KL1B 30 EB 120	335.73



Schluter®-KERDI-LINE

GRATE ASSEMBLY - CHROME

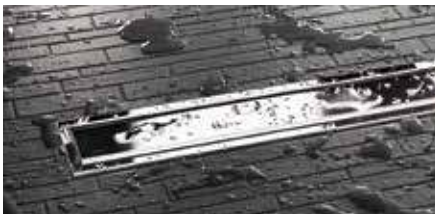

Closed (A)

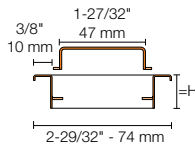

Perforated (B)

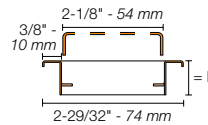

Grate assemblies - Chrome



3/4" (19 mm) frame height for
1/8" to 9/16" (3 mm to 15 mm) -thick coverings

Length = in. - cm	Closed (A)		Perforated (B)	
	Item No.	Retail price	Item No.	Retail price
19-11/16 - 50	KL1AR 19 EP 50	307.82	KL1B 19 EP 50	280.12
23-5/8 - 60	KL1AR 19 EP 60	316.63	KL1B 19 EP 60	285.47
27-9/16 - 70	KL1AR 19 EP 70	329.63	KL1B 19 EP 70	301.24
31-1/2 - 80	KL1AR 19 EP 80	338.16	KL1B 19 EP 80	306.71
35-7/16 - 90	KL1AR 19 EP 90	354.06	KL1B 19 EP 90	323.41
39-3/8 - 100	KL1AR 19 EP 100	375.24	KL1B 19 EP 100	332.75
43-5/16 - 110	KL1AR 19 EP 110	384.45	KL1B 19 EP 110	344.66
47-1/4 - 120	KL1AR 19 EP 120	391.42	KL1B 19 EP 120	351.21



Frameless Tileable (D)

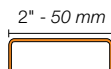

Grate assemblies - Frameless tileable

Length = in. - cm	Item No.		Retail price
	Frameless Tileable (D)		
	For use with center outlet channel body	For use with off-set outlet channel body	
19-11/16 - 50	KL1DRE 50	-	129.56
23-5/8 - 60	KL1DRE 60	-	135.86
27-9/16 - 70	KL1DRE 70	KL1DRO E 70	142.16
31-1/2 - 80	KL1DRE 80	KL1DRO E 80	148.46
35-7/16 - 90	KL1DRE 90	KL1DRO E 90	159.17
39-3/8 - 100	KL1DRE 100	KL1DRO E 100	177.03
43-5/16 - 110	KL1DRE 110	KL1DRO E 110	183.29
47-1/4 - 120	KL1DRE 120	KL1DRO E 120	189.54
51-3/16 - 130	KL1DRE 130	-	228.56
55-1/8 - 140	KL1DRE 140	-	230.52
59-1/16 - 150	KL1DRE 150	-	232.88
62-15/16 - 160	KL1DRE 160	-	255.80
66-7/8 - 170	KL1DRE 170	-	258.32
70-13/16 - 180	KL1DRE 180	-	260.44



Schluter®-KERDI-LINE-STYLE

GRATE ASSEMBLY - BRUSHED STAINLESS STEEL STYLE DESIGNS



Curve

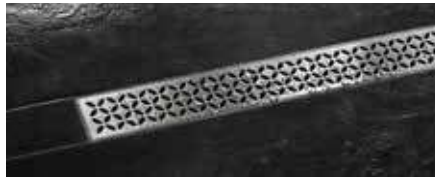
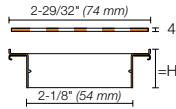

Floral

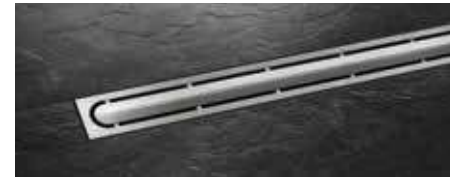
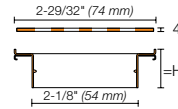

Pure

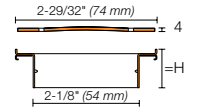

Grate assemblies - Brushed stainless steel							
29/32" - 23 mm frame height for 1/4" - 11/16" (6 - 18 mm) -thick coverings							
Length = in. - cm	Curve ¹		Floral ²		Pure ³		
	Item No.	Retail price	Item No.	Retail price	Item No.	Retail price	
19-11/16 - 50	KL1IFF 23 EB 50	289.90	KL1IFE 23 EB 50	301.27	KL1IFG 23 EB 50	324.01	
23-5/8 - 60	KL1IFF 23 EB 60	301.27	KL1IFE 23 EB 60	312.65	KL1IFG 23 EB 60	335.38	
27-9/16 - 70	KL1IFF 23 EB 70	312.65	KL1IFE 23 EB 70	324.01	KL1IFG 23 EB 70	349.59	
31-1/2 - 80	KL1IFF 23 EB 80	329.70	KL1IFE 23 EB 80	346.75	KL1IFG 23 EB 80	363.80	
35-7/16 - 90	KL1IFF 23 EB 90	346.75	KL1IFE 23 EB 90	369.48	KL1IFG 23 EB 90	380.86	
39-3/8 - 100	KL1IFF 23 EB 100	363.80	KL1IFE 23 EB 100	392.22	KL1IFG 23 EB 100	397.91	
43-5/16 - 110	KL1IFF 23 EB 110	380.86	KL1IFE 23 EB 110	414.96	KL1IFG 23 EB 110	420.64	
47-1/4 - 120	KL1IFF 23 EB 120	397.91	KL1IFE 23 EB 120	437.69	KL1IFG 23 EB 120	443.37	

1. U.S. Patent No. D831,168 2. U.S. Patent No. D831,170 3. U.S. Patent No. D831,169

New grate designs that fit your STYLE!

Solid stainless steel with elegant brushed finish

Thin, discreet frame

Available in 20" to 48" linear drain lengths



Schluter®-KERDI-LINE

PERFORATED GRATE WITH LOCKING MECHANISM

The Schluter®-KERDI-LINE perforated grate assembly (B) with 3/4" (19 mm) frame height is available with a locking mechanism for applications where tamper resistance is required.



Perforated grate assembly with locking mechanism			
Length = in. - cm		Item No.	Retail price
19-11/16	- 50	KL1BL 19 EB 50	281.80
23-5/8	- 60	KL1BL 19 EB 60	285.48
27-9/16	- 70	KL1BL 19 EB 70	299.33
31-1/2	- 80	KL1BL 19 EB 80	303.46
35-7/16	- 90	KL1BL 19 EB 90	319.61
39-3/8	- 100	KL1BL 19 EB 100	325.95
43-5/16	- 110	KL1BL 19 EB 110	336.90
47-1/4	- 120	KL1BL 19 EB 120	341.32
51-3/16	- 130	KL1BL 19 EB 130	500.26
55-1/8	- 140	KL1BL 19 EB 140	523.51
59-1/16	- 150	KL1BL 19 EB 150	549.03
62-15/16	- 160	KL1BL 19 EB 160	582.20
66-7/8	- 170	KL1BL 19 EB 170	605.44
70-13/16	- 180	KL1BL 19 EB 180	638.04

Note: Driver bit for tamper-proof screws sold separately. Please see page 125.

COVER PLATE

Schluter®-KERDI-LINE-FC

Schluter®-KERDI-LINE-FC is a stainless steel cover plate for use with the Schluter®-KERDI-LINE linear floor drain to create a seamless look in applications where multiple drains are installed end to end. KERDI-LINE-FC is designed for use with either the solid or perforated grates.

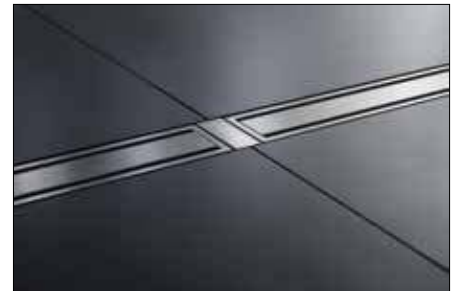
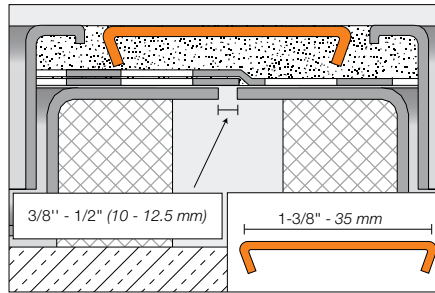
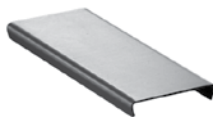

Schluter®-KERDI-LINE-FC Cover Plate			
Brushed stainless steel		Chrome	
Item No.	Retail price	Item No.	Retail price
V / KLEB 35	15.07	V / KLEP 35	15.07

STRAINER

The Schluter®-KERDI-LINE Strainer is a hair catcher customized to fit inside the KERDI-LINE channel body to trap and collect hair. Simple to remove and clean, the hair catcher fits discreetly into the drain to prevent hair clogs that can lead to blocked pipes.



Strainer for KERDI-LINE		
Item No.	Description	\$ / Unit
KL VZ SF	Strainer	2.75



Prefabricated substrates

Prefabricated shower trays, curbs, ramps, benches, and niches integrate seamlessly with KERDI and KERDI-BOARD shower assemblies, and are ideal solutions for including mortar-free shower components in any tiled shower. Quick and easy to install, Schluter prefabricated substrates combine comfort, convenience, and design and are available in multiple sizes and shapes to fit any décor.

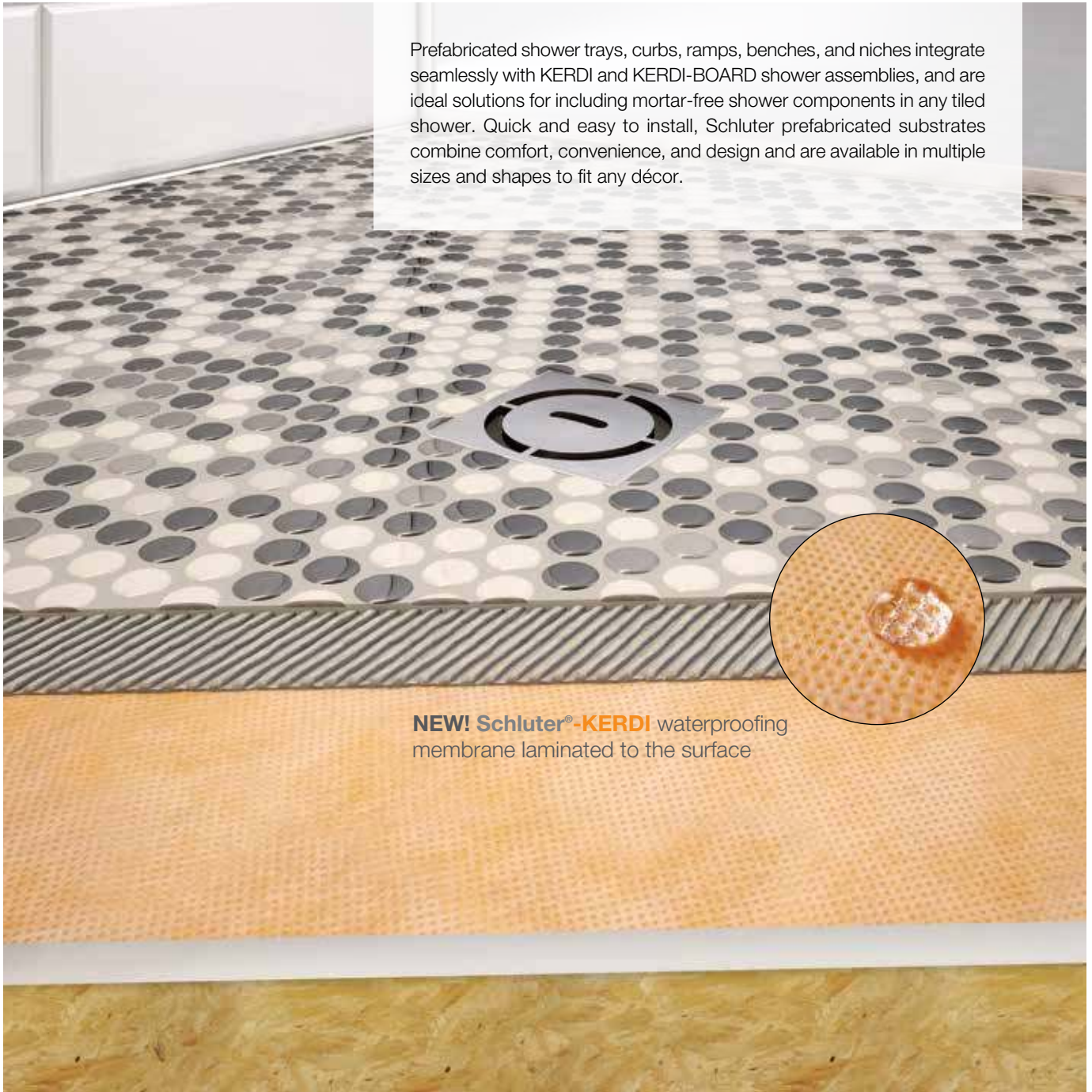

NEW! Schluter®-KERDI waterproofing membrane laminated to the surface





▲ Schluter®-KERDI-SHOWER-T/-TS/-TT

Schluter®-KERDI-SHOWER-T/-TS/-TT are sloped shower trays with integrated KERDI waterproofing. The trays are made of lightweight, expanded polystyrene (PS 40) for constructing mortar-free shower bases. Each of these prefabricated shower trays is designed to integrate with the Schluter®-KERDI-DRAIN.

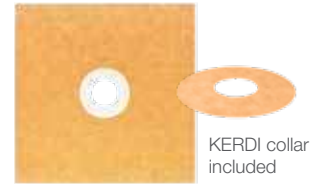

The **KERDI-SHOWER-T** is the standard tray with center drain placement.

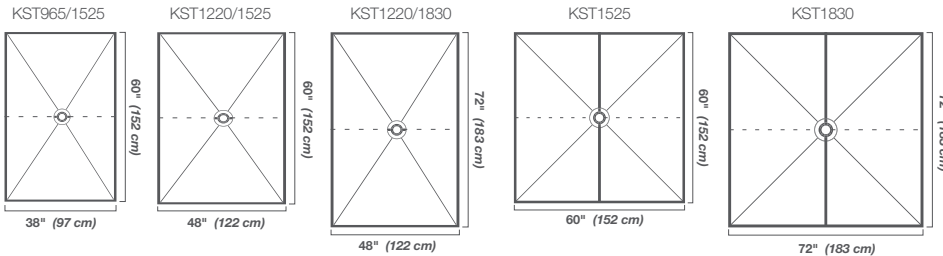

Schluter®-KERDI-SHOWER-T				
Tray with center drain placement				
Item No.	Dimensions	Perimeter height	Drain placement	\$ / Unit
KST965/1525	97 cm x 152 cm (38" x 60")	29 mm (1-1/8")	center	150.00
KST1220/1525	122 cm x 152 cm (48" x 60")	28 mm (1-3/32")	center	227.50
KST1220/1830	122 cm x 183 cm (48" x 72")	32 mm (1-1/4")	center	215.65
KST1525	152 cm x 152 cm (60" x 60")	30 mm (1-3/16")	center	299.00
KST1830	183 cm x 183 cm (72" x 72")	32 mm (1-1/4")	center	312.50

The **KERDI-SHOWER-TS** is the standard tray with off-center drain placement.

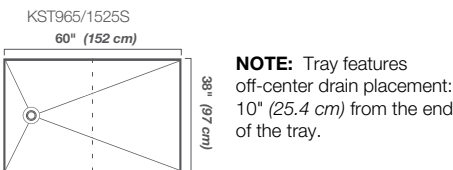

Schluter®-KERDI-SHOWER-TS				
Tray with off-center drain placement				
Item No.	Dimensions	Perimeter height	Drain placement	\$ / Unit
KST965/1525S	97 cm x 152 cm (38" x 60")	38 mm (1-1/2")	off-center	150.00

The **KERDI-SHOWER-TT** features a thin perimeter height that simplifies the construction of curbless showers.

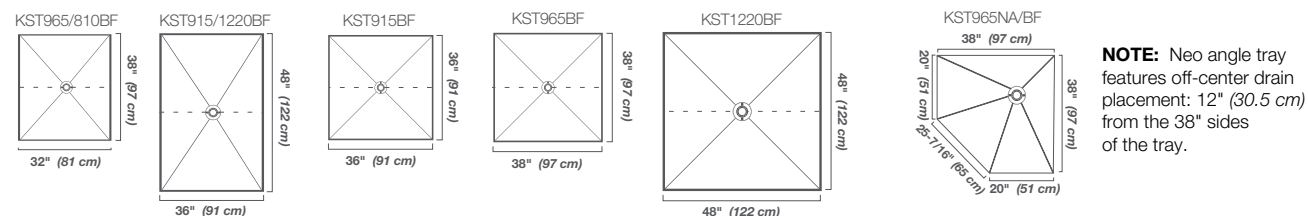

Schluter®-KERDI-SHOWER-TT				
Thin tray				
Item No.	Dimensions	Perimeter height	Drain placement	\$ / Unit
KST965/810BF	81 cm x 97 cm (32" x 38")	23 mm (29/32")	center	149.50
KST915/1220BF	91 cm x 122 cm (36" x 48")	25 mm (1")	center	175.50
KST915BF	91 cm x 91 cm (36" x 36")	22 mm (7/8")	center	103.25
KST965BF	97 cm x 97 cm (38" x 38")	23 mm (29/32")	center	113.25
KST1220BF	122 cm x 122 cm (48" x 48")	25 mm (1")	center	143.75
KST965NA/BF	97 cm x 97 cm (38" x 38") Neo angle	26 mm (1-1/32")	off-center	156.00



Schluter®-KERDI-SHOWER-LT/LTS

Schluter®-KERDI-SHOWER-LT/LTS are polystyrene sloped trays with integrated Schluter®-KERDI waterproofing. Each of these prefabricated shower trays is designed to integrate with the Schluter®-KERDI-LINE.



The **KERDI-SHOWER-LT** allows for the installation of a center drain.

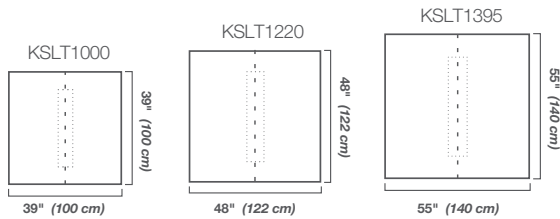

Schluter®-KERDI-SHOWER-LT				
Tray with center linear drain placement				
Item No.	Dimensions	Perimeter height	Drain placement	\$ / Unit
KSLT1000	100 cm x 100 cm (39" x 39")	32 mm (1-1/4")	center	187.50
KSLT1220	122 cm x 122 cm (48" x 48")	34 mm (1-3/8")	center	250.00
KSLT1395	140 cm x 140 cm (55" x 55")	36 mm (1-7/16")	center	315.00

The **KERDI-SHOWER-LTS** accommodates the installation of the drain along the perimeter of the shower.

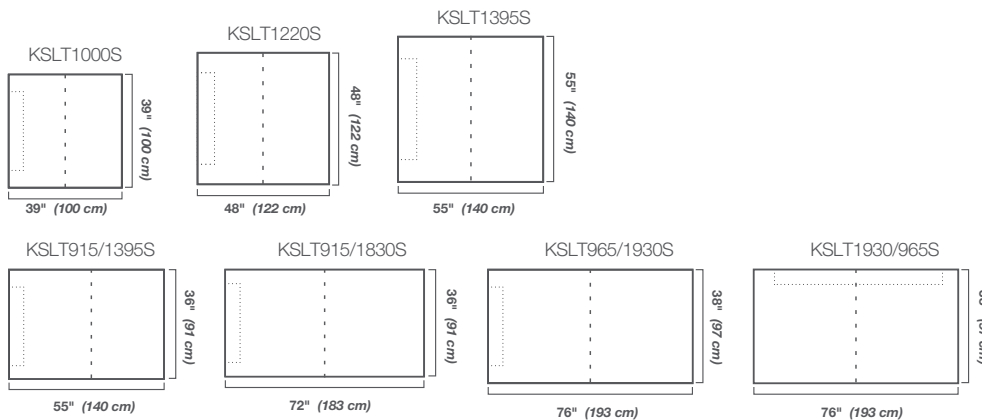

Schluter®-KERDI-SHOWER-LTS				
Tray with perimeter linear drain placement				
Item No.	Dimensions	Perimeter height	Drain placement	\$ / Unit
KSLT1000S	100 cm x 100 cm (39" x 39")	42 mm (1-21/32")	perimeter	187.50
KSLT1220S	122 cm x 122 cm (48" x 48")	46 mm (1-13/16")	perimeter	250.00
KSLT1395S	140 cm x 140 cm (55" x 55")	50 mm (2")	perimeter	315.00
KSLT915/1395S	91 cm x 140 cm (36" x 55")	50 mm (2")	perimeter	286.00
KSLT915/1830S	91 cm x 183 cm (36" x 72")	58 mm (2-5/16")	perimeter	295.00
KSLT965/1930S	97 cm x 193 cm (38" x 76")	60 mm (2-3/8")	perimeter	325.00
KSLT1930/965S	193 cm x 97 cm (76" x 38")	41 mm (1-5/8")	perimeter	325.00

Schluter®-KERDI-BOARD-SC

Schluter®-KERDI-BOARD-SC is a prefabricated shower curb made of KERDI-BOARD that is designed to integrate with the Schluter®-Shower System. The curb is lightweight, stable, and load bearing. It can be used in conjunction with the KERDI-SHOWER prefabricated shower trays as well as in mortar bed applications. KERDI-BOARD-SC is quick and easy to install, waterproof and ready to tile, making it a simple solution for tiled shower curbs.

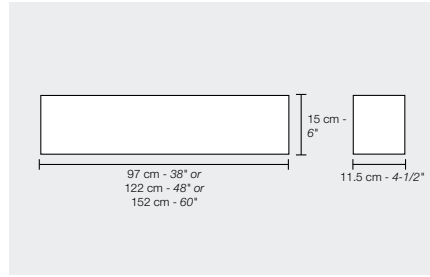

Schluter®-KERDI-BOARD-SC		
Curb		
Item No.	Dimensions	\$ / Unit
KBSC 115 150 970	97 cm x 15 cm x 11.5 cm (38" x 6" x 4-1/2")	67.00
KBSC 115 150 1220	122 cm x 15 cm x 11.5 cm (48" x 6" x 4-1/2")	75.00
 KBSC 115 150 1524	152 cm x 15 cm x 11.5 cm (60" x 6" x 4-1/2")	103.00

Schluter®-KERDI-SHOWER-SR

Schluter®-KERDI-SHOWER-SR is a lightweight, expanded polystyrene (PS 40) shower ramp specifically designed to integrate with Schluter®-Shower System.

Includes a pre-cut piece of KERDI

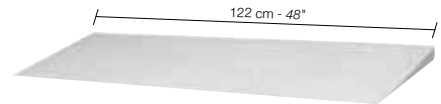
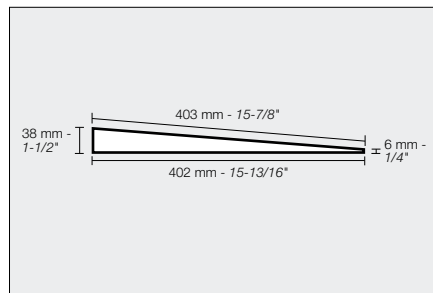

Schluter®-KERDI-SHOWER-SR		
Ramp		
Item No.	Dimensions	\$ / Unit
SR 122	122 cm x 40 cm (48" x 15-7/8")	67.43



Schluter®-KERDI-BOARD-SB

Schluter®-KERDI-BOARD-SB is a prefabricated shower bench made of KERDI-BOARD that is designed to integrate with the Schluter®-Shower System. The bench is lightweight, stable, and load bearing. It features a sloped surface to prevent the accumulation of water. KERDI-BOARD-SB is quick and easy to install, waterproof and ready to tile, making it a simple solution for tiled shower benches.

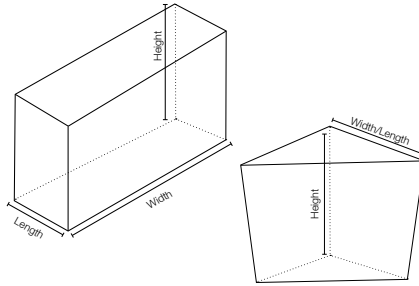

Includes 2 inside and 2 outside
KERDI-KERECK waterproofing corners.

Schluter®-KERDI-BOARD-SB					
Bench					
Item No.	Width	Length	Height	Shape	\$ / Unit
KBSB 410 TA	16" (41 cm)	16" (41 cm)	20" (51 cm)	Triangular	185.00
KBSB 610 TA	24" (61 cm)	24" (61 cm)	20" (51 cm)	Triangular	250.00
KBSB 290 970 RA	38" (97 cm)	11-1/2" (29 cm)	20" (51 cm)	Rectangular	310.00
KBSB 410 1220 RA	48" (122 cm)	16" (41 cm)	20" (51 cm)	Rectangular	409.00

Schluter®-KERDI-BOARD-SN

Schluter®-KERDI-BOARD-SN is a prefabricated shower niche made of Schluter®-KERDI-BOARD that can be installed in both Schluter®-KERDI and KERDI-BOARD wall assemblies. The shower niche features a 1/2" (12.5 mm) -thick by 2" (50 mm) -wide integrated bonding flange and is available in 4 different sizes. Larger sizes include a prefabricated KERDI-BOARD shelf that can be installed at any height to create separate compartments within the shower niche if desired.

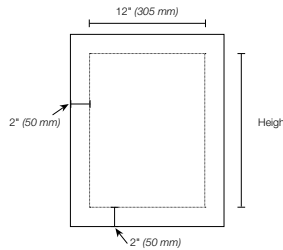

Schluter®-KERDI-BOARD-SN					
Niche					
Item No.	Height	Width	Depth	Shelf	\$ / Unit
KB 12 SN 305 152 A	6" (152 mm)	12" (305 mm)	3-1/2" (89 mm)	-	56.96
KB 12 SN 305 305 A	12" (305 mm)	12" (305 mm)	3-1/2" (89 mm)	-	68.22
KB 12 SN 305 508 A1	20" (508 mm)	12" (305 mm)	3-1/2" (89 mm)	1	92.21
KB 12 SN 305 711 A1	28" (711 mm)	12" (305 mm)	3-1/2" (89 mm)	1	110.21

Kits

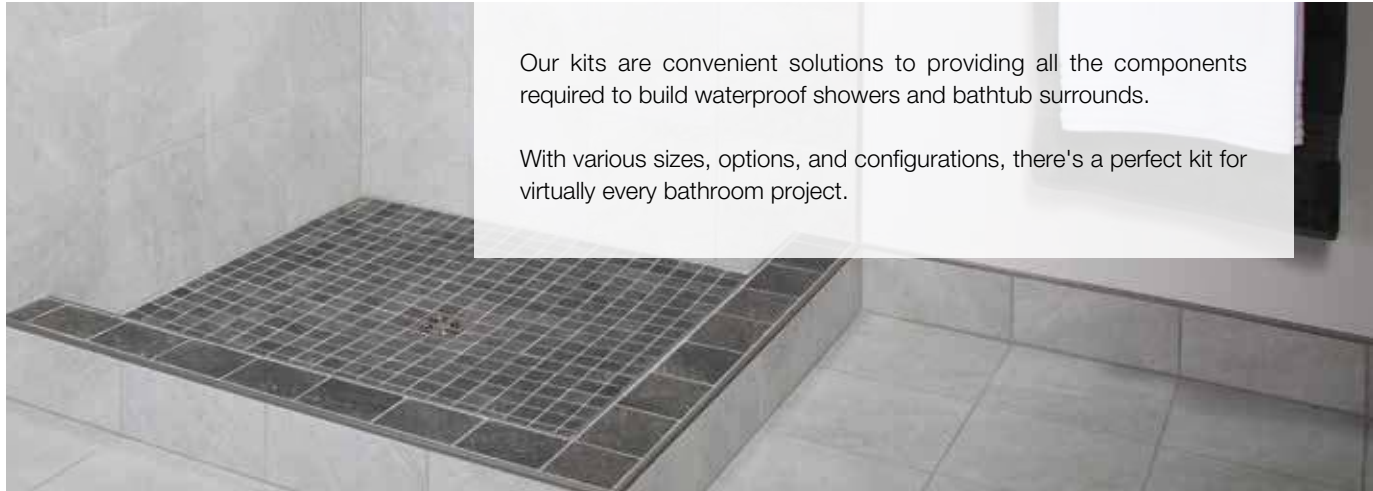

Our kits are convenient solutions to providing all the components required to build waterproof showers and bathtub surrounds.

With various sizes, options, and configurations, there's a perfect kit for virtually every bathroom project.

Schluter®-KERDI-SHOWER-KIT

The **Schluter®-KERDI-SHOWER-KIT** is an all-inclusive package containing each of the integrated family of components required to create a maintenance-free, watertight shower assembly without a mortar bed.



Now featuring the KERDI-SHOWER-T/-TS/-TT shower tray with integrated KERDI waterproofing, and the KERDI-BOARD-SC curb.

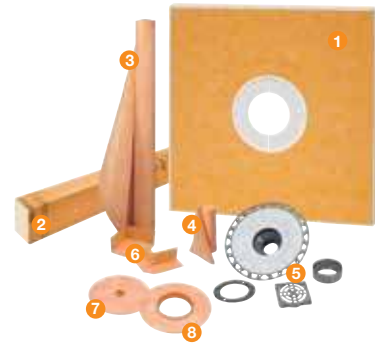
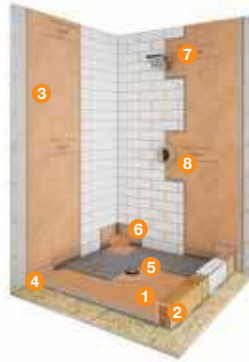

Includes		Description	Quantity	
			48" x 48"	38" x 60"
1	KERDI-SHOWER-T/-TS/-TT	Shower Tray	1	1
2	KERDI-BOARD-SC	Shower Curb 48" x 6" x 4-1/2"	1	
	KERDI-BOARD-SC	Shower Curb 38" x 6" x 4-1/2"		2
3	KERDI 10 M	Waterproofing membrane 3' 3" x 33' = 108 ft²	1	1
4	KERDI-BAND	Waterproofing strip 5" x 33'	1	1
5	KERDI-DRAIN	Flange with 2" (50 mm) outlet and stainless steel grate (E)	1	1
6	KERDI-KERECK-F	Preformed waterproofing corners	4 inside and 2 outside	
7	KERDI-SEAL-PS	Pipe seal (3/4" - 20 mm)	1	
8	KERDI-SEAL-MV	Mixing valve seal (4-1/4" - 114 mm)	1	

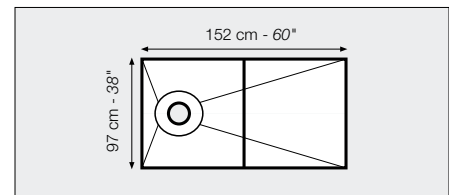
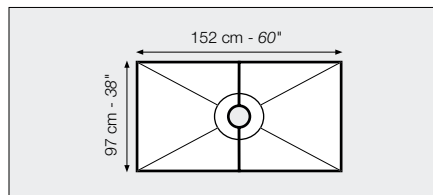
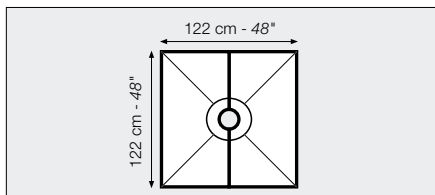

48" x 48" Kit - ABS or PVC			
Item No.	Drain Material	Grate finish	Retail price
KSK 1220 ABS E	ABS	E	579.29
KSK 1220 PVC E	PVC	E	579.29

38" x 60" Kit - ABS or PVC			
Item No.	Drain Material	Grate finish	Retail price
KSK 965 1525 ABS E	ABS	E	626.00
KSK 965 1525 PVC E	PVC	E	626.00

38" x 60" Kit off-center - ABS or PVC			
Item No.	Drain Material	Grate finish	Retail price
KSK 965 1525S ABSE	ABS	E	626.00
KSK 965 1525S PVCE	PVC	E	626.00

Note: Tray features off-center drain placement: 10" (25.4 cm) o.c. from end of tray.



Schluter®-KERDI-SHOWER-KIT

▲ WITHOUT THE GRATE

This kit contains all the elements of the complete KERDI-SHOWER-KIT except the drain grate. This simplifies the stocking of a wide variety of KERDI-SHOWER-T/-TS/-TT tray and KERDI-DRAIN grate combinations.



Now featuring the KERDI-SHOWER-T/-TS/-TT shower tray with integrated KERDI waterproofing, and the KERDI-BOARD-SC curb.

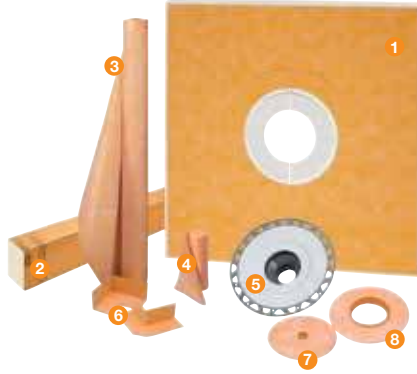

KERDI-DRAIN Grates sold separately

See pages 120-121



Includes		Description	Quantity			
			48" x 48"	38" x 60"	48" x 72"	72" x 72"
1	KERDI-SHOWER-T/-TS/-TT	Shower Tray	1	1	1	1
2	KERDI-BOARD-SC	Shower Curb 48" x 6" x 4-1/2"	1			
	KERDI-BOARD-SC	Shower Curb 38" x 6" x 4-1/2"		2	2	2
3	KERDI 5 M	Waterproofing membrane 3' 3" x 16' 5" = 54 ft ²				1
	KERDI 10 M	Waterproofing membrane 3' 3" x 33' = 108 ft ²	1	1		1
	KERDI 12 M	Waterproofing membrane 3' 3" x 39' 4" = 128 ft ²			1	
4	KERDI-BAND	Waterproofing strip 5" x 33'			2	2
5	KERDI-DRAIN Flange	Flange with 2" (50 mm) outlet	1	1	1	1
6	KERDI-KERECK-F	Preformed waterproofing corners	4 inside and 2 outside			
7	KERDI-SEAL-PS	Pipe seal (3/4" - 20 mm)	1			
8	KERDI-SEAL-MV	Mixing valve seal (4-1/2" - 114 mm)	1			

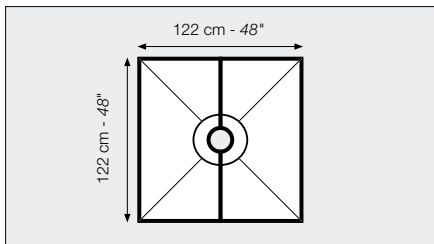

48" x 48" Kit - ABS or PVC		
Item No.	Drain Material	Retail price
KSK 1220 ABS	ABS	526.97
KSK 1220 PVC	PVC	526.97

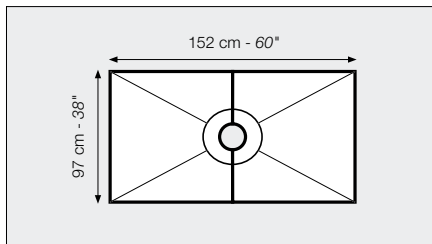

38" x 60" Kit - ABS or PVC		
Item No.	Drain Material	Retail price
KSK 965 1525 ABS	ABS	572.88
KSK 965 1525 PVC	PVC	572.88

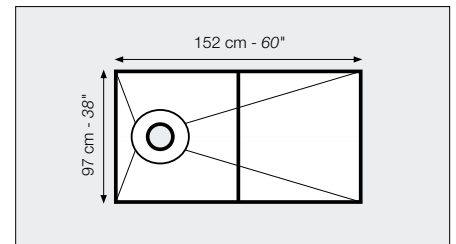

38" x 60" Kit off-center - ABS or PVC		
Item No.	Drain Material	Retail price
KSK 965 1525S ABS	ABS	572.88
KSK 965 1525S PVC	PVC	572.88

Note: Tray features off-center drain placement: 10" (25.4 cm) o.c. from end of tray.

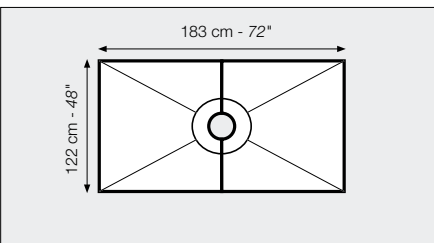

48" x 72" Kit - ABS or PVC		
Item No.	Drain Material	Retail price
KSK 1220 1830 ABS	ABS	782.54
KSK 1220 1830 PVC	PVC	782.54

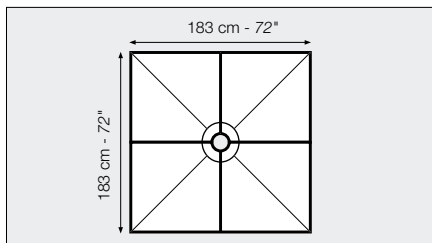

72" x 72" Kit - ABS or PVC		
Item No.	Drain Material	Retail price
KSK 1830 ABS	ABS	969.52
KSK 1830 PVC	PVC	969.52

Schluter®-KERDI-SHOWER-KIT

WITHOUT THE DRAIN

This kit contains all the elements of the complete KERDI-SHOWER-KIT except the KERDI-DRAIN. This simplifies the stocking of a wide variety of KERDI-SHOWER-T/-TS/-TT trays and KERDI-DRAIN combinations.

NEW! Now featuring the KERDI-SHOWER-T/-TS/-TT shower tray with integrated KERDI waterproofing, and the KERDI-BOARD-SC curb.

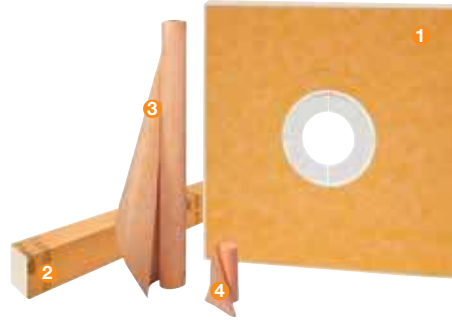

KERDI-DRAIN grates and flanges sold separately

Grates - See pages 120-121
Flanges - See pages 116-119



Includes		Description	Quantity			
			48" x 48"	38" x 60"	48" x 72"	72" x 72"
1	KERDI-SHOWER-T/-TS/-TT	Shower Tray	1	1	1	1
2	KERDI-BOARD-SC	Shower Curb 48" x 6" x 4-1/2"	1			
	KERDI-BOARD-SC	Shower Curb 38" x 6" x 4-1/2"		2	2	2
3	KERDI 5 M	Waterproofing membrane 3' 3" x 16' 5" = 54 ft²				1
	KERDI 10 M	Waterproofing membrane 3' 3" x 33' = 108 ft²	1	1		1
	KERDI 12 M	Waterproofing membrane 3' 3" x 39' 4" = 128 ft²			1	
4	KERDI-BAND	Waterproofing strip 5" x 33'	1	1	2	2

Tray size	Item No.	Retail price
48" x 48"	KSK 1220	452.09
38" x 60"	KSK 965 1525	498.00
38" x 60" off-center drain	KSK 965 1525S	498.00
48" x 72"	KSK 1220 1830	707.66
72" x 72"	KSK 1830	894.64

Schluter®-KERDI-TUBKIT

The Schluter®-KERDI-TUBKIT contains all the components necessary to create a fully waterproof and vapor tight bathtub surround assembly.



Includes		Description	Quantity
1	KERDI 7M	Waterproofing membrane 3' 3" x 23' = 75 ft²	1
2	KERDI-BAND	Waterproofing strip 5" x 16' 5"	1
3	KERDI-SEAL-PS	Pipe seal (3/4" - 20 mm)	1
4	KERDI-SEAL-MV	Mixing valve seal (4-1/2" - 114 mm)	1
5	KERDI-FIX	Sealing and bonding compound, bright white (290 ml - 9.81 oz.)	1

Item No.	Retail price
KKB7	235.00



Schluter®-KERDI-BOARD-KIT

The **Schluter®-KERDI-BOARD-KIT** contains KERDI-BOARD panels and all the other components necessary to create a fully waterproof and vapor tight tile application around bathtubs and acrylic shower bases, all in one convenient package.



Schluter®-KERDI-BOARD-KIT		
Includes	Description	Quantity
1 KERDI-BOARD	Waterproof building panel 1/2" x 48" x 38" (1.25 cm x 122 cm x 97 cm) Total coverage = 101 ft² (9.4 m²)	8
2 KERDI-BAND	Waterproofing strip 5" x 98' 5" (125 mm x 30 m)	1
3 KERDI-SEAL-PS	Pipe seal	1x 1/2" (12.5 mm) 1x 3/4" (20 mm)
4 KERDI-SEAL-MV	Mixing valve seal 4-1/2" (114 mm)	1
5 KERDI-BOARD-ZT/-ZS	Screws and washers	140
6 KERDI-FIX	Sealing and bonding compound, bright white (290 ml – 9.81 oz.)	2

Item No.	Retail price
KBKIT	617.00



Shower accessories



Accessories are used to enhance tiled shower applications, providing shelving, splashguards at the entrances to curbless showers, support channels for glass walls, and wall finishing that eliminates the need to cut wedges of tile in KERDI-LINE applications.

▲ Schluter®-SHELF-W

Schluter®-SHELF-W is a rectangular, brushed stainless steel shelf designed for tiled walls. Available in the Floral and Curve STYLE designs, the shelf features a double anchoring leg for installation in tandem with the tile.

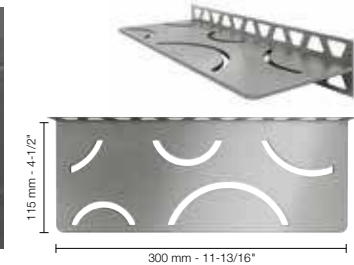
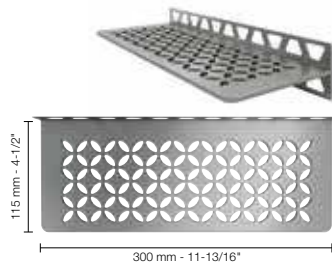
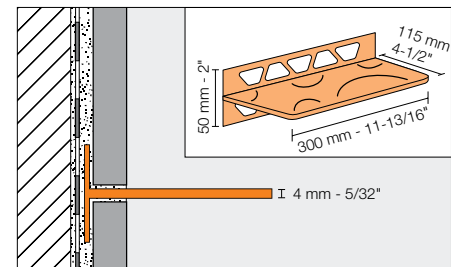

Schluter®-SHELF-W		
Brushed stainless steel		
Item No.	Design	\$ / Unit
SWS1 D5 EB	Floral	108.01

Schluter®-SHELF-W		
Brushed stainless steel		
Item No.	Design	\$ / Unit
SWS1 D6 EB	Curve	127.66



Schluter®-SHELF-E

Schluter®-SHELF-E is a brushed stainless steel corner shelf designed for tiled walls. Available in 3 shapes and in the Floral and Curve STYLE designs, the shelf features 3/32" (2 mm) -thick anchoring tabs which allow for easy installation either in tandem with the tile, or as a retrofit application.

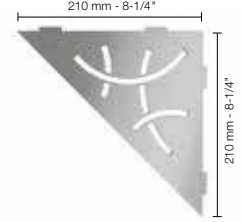
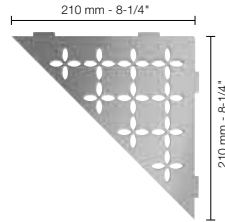
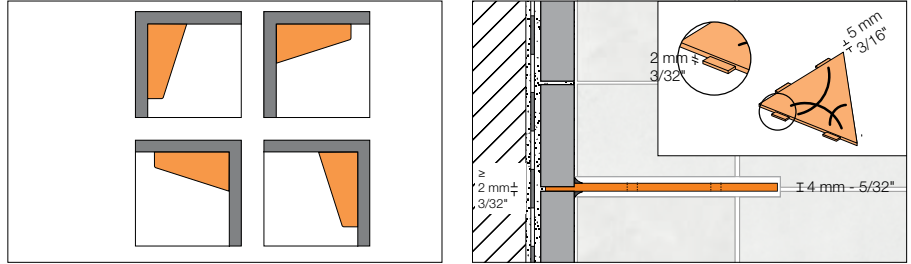

Schluter®-SHELF-E		
Brushed stainless steel		
Item No.	Design	\$/ Unit
SES1 D5 EB	Floral	105.28

Schluter®-SHELF-E		
Brushed stainless steel		
Item No.	Design	\$/ Unit
SES1 D6 EB	Curve	110.57

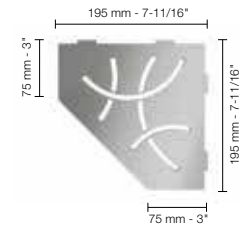
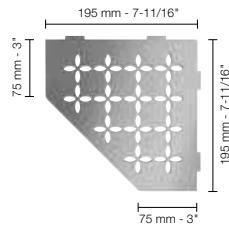

Schluter®-SHELF-E		
Brushed stainless steel		
Item No.	Design	\$/ Unit
SES2 D5 EB	Floral	100.99

Schluter®-SHELF-E		
Brushed stainless steel		
Item No.	Design	\$/ Unit
SES2 D6 EB	Curve	109.01

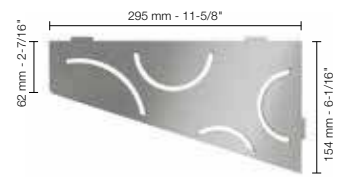
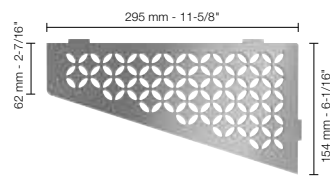

Schluter®-SHELF-E		
Brushed stainless steel		
Item No.	Design	\$/ Unit
SES3 D5 EB	Floral	130.60

Schluter®-SHELF-E		
Brushed stainless steel		
Item No.	Design	\$/ Unit
SES3 D6 EB	Curve	154.84



Schluter®-SHELF-N

Schluter®-SHELF-N is a rectangular, brushed stainless steel shelf designed to fit into Schluter®-KERDI-BOARD-SN prefabricated niches. Available in the Floral and Curve STYLE designs, the shelf can be easily installed in tandem with the tile.

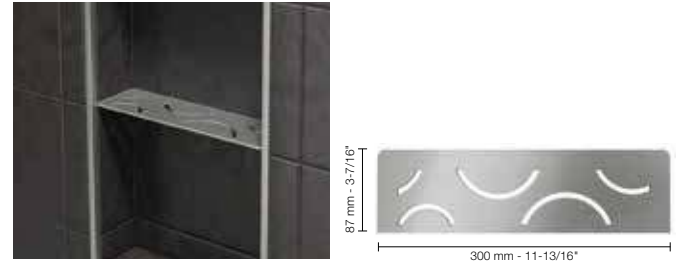
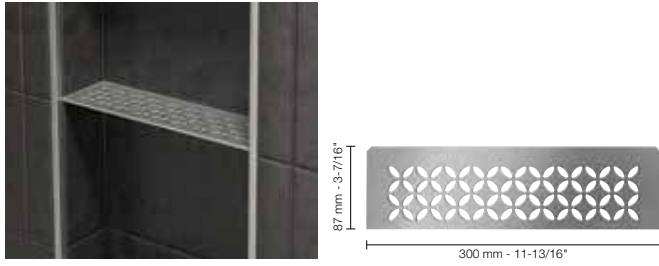
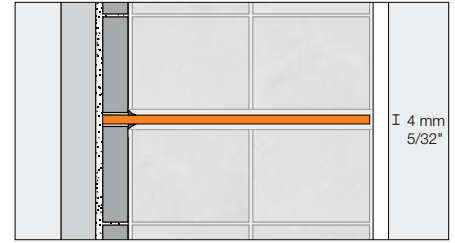

Schluter®-SHELF-N		
Brushed stainless steel		
Item No.	Design	\$ / Unit
SNS1 D5 EB	Floral	116.24

Schluter®-SHELF-N		
Brushed stainless steel		
Item No.	Design	\$ / Unit
SNS1 D6 EB	Curve	125.73





Schluter®-SHOWERPROFILE-S

The **Schluter®-SHOWERPROFILE-S** is a two-part profile with a tapered edge, designed to cover adjoining tile edges that become exposed as the shower floor slopes to accommodate drainage to the Schluter®-KERDI-LINE. The tapered profile features a visible surface of brushed stainless steel and a fleece fabric on the reverse for bonding with the tile adhesive. It is designed to be inserted into the U-shaped groove of the matching hard PVC support profile. The profile can be used for lateral transitions to the wall or the adjoining floor.

Note: Tapered profiles with higher support profiles in the heights 9/16" (15 mm), 23/32" (18 mm), and 7/8" (22 mm) are available upon request for greater tile thicknesses. Please contact Customer Service for price and delivery times.

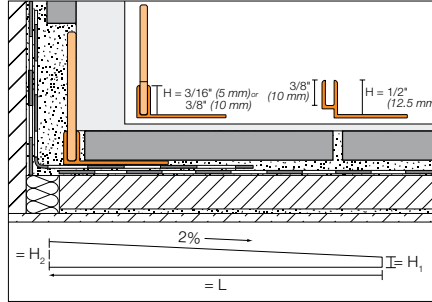

Schluter®-SHOWERPROFILE-SA				
Two-part tapered edging profile				
H = in. - mm	Item No.	H ₁ = in. - mm	H ₂ = in. - mm	Retail price
L = 47-1/4" - 1.2 m				
3/16 - 5	SPSA 50 EB/120	1/4 - 6	1-3/16 - 30	62.95
L = 63" - 1.6 m				
3/16 - 5	SPSA 50 EB/160	1/4 - 6	1-1/2 - 38	82.43
L = 78-3/4" - 2 m				
3/16 - 5	SPSA 50 EB/200	1/4 - 6	1-13/16 - 46	183.49

Canada Patent No. 2729076

Schluter®-SHOWERPROFILE-SB				
Two-part tapered edging profile				
H = in. - mm	Item No.	H ₁ = in. - mm	H ₂ = in. - mm	Retail price
L = 47-1/4" - 1.2 m				
3/8 - 10	SPSB 100 EB/120	3/8 - 10	1-11/32 - 34	62.95
1/2 - 12.5	SPSB 125 EB/120	3/8 - 10	1-11/32 - 34	70.14
L = 63" - 1.6 m				
3/8 - 10	SPSB 100 EB/160	3/8 - 10	1-21/32 - 42	82.43
1/2 - 12.5	SPSB 125 EB/160	3/8 - 10	1-21/32 - 42	91.30
L = 78-3/4" - 2 m				
3/8 - 10	SPSB 100 EB/200	3/8 - 10	2 - 50	204.75
1/2 - 12.5	SPSB 125 EB/200	3/8 - 10	2 - 50	204.75

Canada Patent No. 2729076

Schluter®-SHOWERPROFILE-R

The **Schluter®-SHOWERPROFILE-R** is a two part wall transition profile made of brushed stainless steel for covering the exposed wall area where the floor slopes down to a perimeter linear drain. A fleece fabric is laminated on the reverse of the profile for bonding with the tile adhesive. The two-part design of Schluter®-SHOWERPROFILE-R can be seamlessly adjusted to any height between 29/32" (23 mm) and 1-25/32" (45 mm) (available in two versions). The profile is available in lengths of 39" (1 m) and 55" (1.4 m) and can be cut to the desired length.

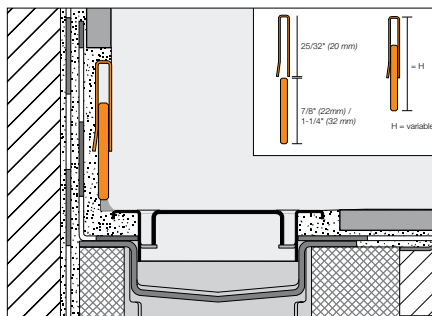

Schluter®-SHOWERPROFILE-R		
Two-part wall transition profile		
H = in. - mm	Item No.	Retail price
L = 39" - 1 m		
29/32 - 1-3/8 (23 - 35)	SPRA 23 EB/100	76.60
1-5/16 - 1-25/32 (33 - 45)	SPRA 33 EB/100	83.48
L = 55" - 1.4 m		
29/32 - 1-3/8 (23 - 35)	SPRA 23 EB/140	88.15
1-5/16 - 1-25/32 (33 - 45)	SPRA 33 EB/140	98.65

Canada Patent No. 2729076

Schluter®-SHOWERPROFILE-WS

The **Schluter®-SHOWERPROFILE-WS** is a two-part profile that forms a splashguard at the entrance of barrier-free showers. The anodized aluminum support profile is set in conjunction with the tile covering and can be combined with either a semi-circular lip made of rigid PVC or a collapsible upright lip made of transparent polyurethane. Both variants allow for wheelchair accessibility.

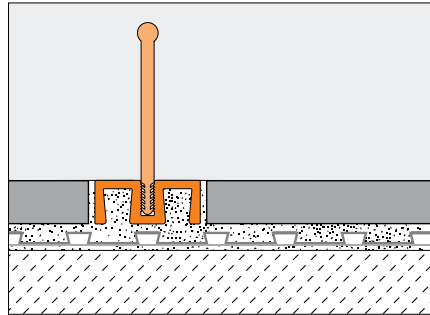

Schluter®-SHOWERPROFILE-WS

Satin anodized aluminum support profile

H = in. - mm	Item No.	Retail price
L = 39" - 1 m		
5/16 - 8	SPWS 19 AE / 100	22.37
L = 8' 2-1/2" - 2.5 m		
5/16 - 8	SPWS 19 AE	50.00

Schluter®-SHOWERPROFILE-WSC

Semi-circular lip

H = in. - mm	Item No.	Retail price
L = 39" - 1 m		
5/16 - 8	SPWSC 16 GS / 100	11.67
L = 8' 2-1/2" - 2.5 m		
5/16 - 8	SPWSC 16 GS	25.66

Schluter®-SHOWERPROFILE-WSL

Straight lip

H = in. - mm	Item No.	Retail price
L = 39" - 1 m		
5/16 - 8	SPWSL 30 T / 100	14.11
L = 8' 2-1/2" - 2.5 m		
5/16 - 8	SPWSL 30 T	31.05

ADA-Compliant

Note: SHOWERPROFILE-WS with the WSL straight lip insert is not ADA-compliant.

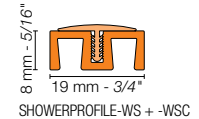
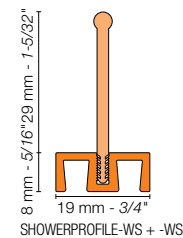

Schluter®-SHOWERPROFILE-WSK

The **Schluter®-SHOWERPROFILE-WSK** is a two-part profile that forms a splashguard at the entrance of barrier-free showers. The anodized aluminum support profile is adhered to existing coverings and can be combined with either a semi-circular lip made of rigid PVC or a collapsible upright lip made of transparent polyurethane. Both variants allow for wheelchair accessibility.

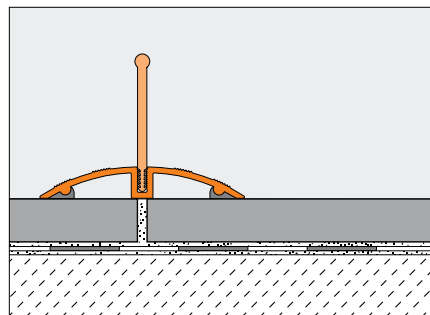

Schluter®-SHOWERPROFILE-WSK

Satin anodized aluminum support profile

H = in. - mm	Item No.	Retail price
L = 39" - 1 m		
5/16 - 8	SPWSK 52 AE / 100	26.22
L = 8' 2-1/2" - 2.5 m		
5/16 - 8	SPWSK 52 AE	59.81

Schluter®-SHOWERPROFILE-WSC

Semi-circular lip

H = in. - mm	Item No.	Retail price
L = 39" - 1 m		
5/16 - 8	SPWSC 16 GS / 100	11.67
L = 8' 2-1/2" - 2.5 m		
5/16 - 8	SPWSC 16 GS	25.66

Schluter®-SHOWERPROFILE-WSL

Straight lip

H = in. - mm	Item No.	Retail price
L = 39" - 1 m		
5/16 - 8	SPWSL 30 T / 100	14.11
L = 8' 2-1/2" - 2.5 m		
5/16 - 8	SPWSL 30 T	31.05

Schluter®-SHOWERPROFILE-WSK-EK

End cap

H = in. - mm	Item No.	Retail price
5/16 - 8	EK / SPWSK 52 AE	4.79

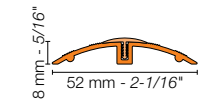
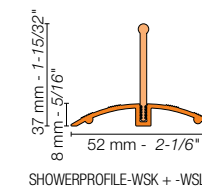

ADA-Compliant

Note: SHOWERPROFILE-WSK with the WSL straight lip insert is not ADA-compliant.



Schluter®-DECO-SG

Schluter®-DECO-SG is a decorative profile featuring a 1/2" (12.5 mm) or 9/16" (15 mm) wide channel that creates a shadow gap between tile courses or other wall covering. The profile may also be used as a support channel for glass walls. The 1/2" wide channel accommodates glass walls up to a thickness of 3/8" (10 mm), and the 9/16" wide channel accommodates glass walls up to a thickness of 1/2" (12.5 mm). DECO-SG features a trapezoid-perforated anchoring leg that is secured in the bond coat beneath the tile.

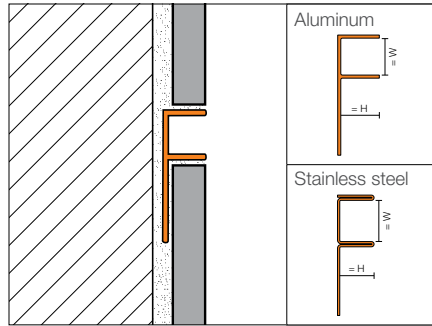



Schluter®-DECO-SG						
Length = 2.5 m - 8' 2-1/2"	▲ Brushed stainless steel 304 (1.4301 = V2A) (EB)		Satin anodized aluminum (AE)		Bright chrome anod. alu. (ACB)	
H = mm - in.	Item No.	\$ / Length	Item No.	\$ / Length	Item No.	\$ / Length
W: 12.5 mm - 1/2"						
8 - 5/16	SG 80 EB 12	69.54	SG 80 AE 12	19.01	SG 80 ACB 12	19.79
10 - 3/8	SG 100 EB 12	74.68	SG 100 AE 12	20.00	SG 100 ACB 12	20.69
11 - 7/16	SG 110 EB 12	77.54	SG 110 AE 12	20.53	SG 110 ACB 12	21.32
12.5 - 1/2	SG 125 EB 12	81.56	SG 125 AE 12	21.26	SG 125 ACB 12	22.05
▲ W: 15 mm - 9/16"						
8 - 5/16	SG 80 EB 15	71.69	SG 80 AE 15	19.96	SG 80 ACB 15	20.78
10 - 3/8	SG 100 EB 15	76.61	SG 100 AE 15	21.00	SG 100 ACB 15	21.72
11 - 7/16	SG 110 EB 15	79.94	SG 110 AE 15	21.56	SG 110 ACB 15	22.39
12.5 - 1/2	SG 125 EB 15	83.24	SG 125 AE 15	22.32	SG 125 ACB 15	23.15

Schluter®-KERDI-FIX

Schluter®-KERDI-FIX is a single-component sealing and bonding compound with a silane-modified polymer base. It is odor-neutral, UV- and weather-resistant, and contains no solvents. KERDI-FIX is elastomeric and bonds well to most materials, such as wood, stone, concrete, metal, glass, and many plastics. KERDI-FIX is suitable for bonding and Schluter®-KERDI waterproofing membrane and Schluter®-KERDI-BAND to fixed building elements. KERDI-FIX is also suitable for use as a sealant.



*Color Codes	
 BW Bright white	 G Grey

Schluter®-KERDI-FIX	
Cartridge (290 ml – 9.81 oz.)	
Item No.	\$ / Unit
KERDIFIX / + color*	28.48

Schluter®-KERDI-FIX	
Tube (100 ml – 3.38 oz.) - Grey (G)	
Item No.	\$ / Unit
KERDIFIX 100 G	16.40



Schluter®-BEKOTEC

MODULAR SCREED SYSTEM FOR CONVENTIONAL AND RADIANT-HEATED SCREEDS

Schluter®-BEKOTEC is a modular screed system that produces permanent flooring assemblies that are free from internal stresses. The BEKOTEC system is based on a studded polystyrene screed panel. The studs confine curing stresses to small modules, which eliminates curling and allows the installation of continuous screed surfaces without any wire reinforcement or control joints. BEKOTEC is ideal for hydronic radiant heating applications, as it provides thermal insulation, allows for hydronic radiant tube application without fasteners, and reduces thermal mass to produce a responsive system that can operate at a low temperature range. The BEKOTEC system can also be used in conjunction with common sound insulation materials to produce a flooring system with excellent sound attenuation properties.





Schluter®-BEKOTEC and Schluter®-BEKOTEC-F

The **Schluter®-BEKOTEC** family of products are lightweight modular screed systems that are used to create continuous screed surfaces without control joints or reinforcement and can also accommodate hydronic radiant heating tubes 3/8"-5/8" (10-16 mm) O.D.. They produce permanent flooring assemblies that are free from internal stresses by confining the shrinkage and curing stresses to smaller modules, which controls deformations such as curling and continuous cracks that are common in traditional screeds. Since they are floating systems, the assemblies can be customized to meet a range of heat and sound requirements. For use with ceramic tile, natural stone, or other surface coverings.

Schluter®-BEKOTEC is 1-3/8" (35 mm) -thick and is made of expanded polystyrene.

Schluter®-BEKOTEC-F is 29/32" (23 mm) -thick, and is made of polystyrene foil.

EN/US/P = Screed panel

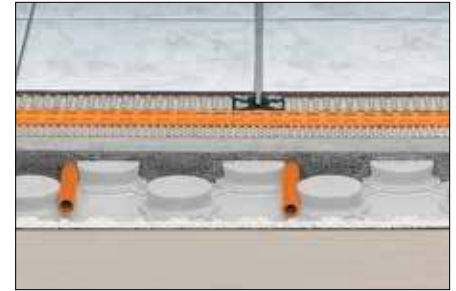
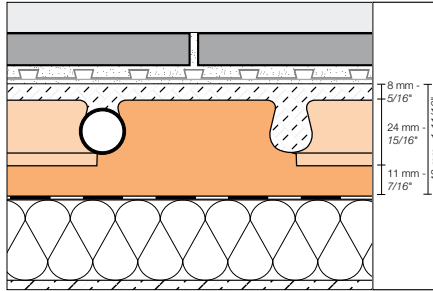
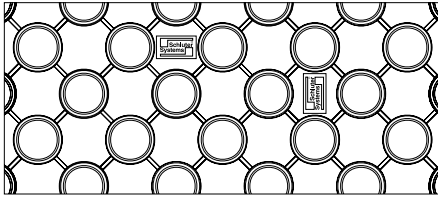

Schluter®-BEKOTEC			
Studded screed panel 1-3/8" (35 mm)			
Item No.	Dimensions/Sheet	Packaging	\$ / Box
EN/US/P	61 x 122 cm = 0.74 m ² (24" x 48" = 8 ft ²)	12 sheets / box	186.52

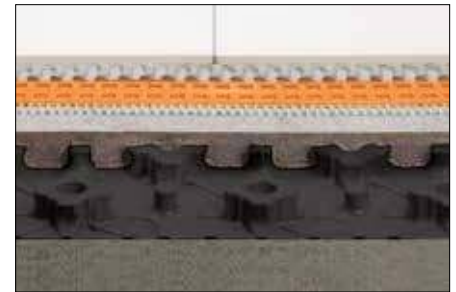
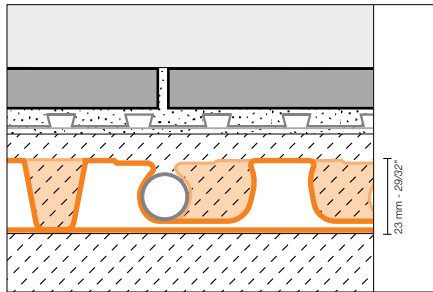

Schluter®-BEKOTEC-F			
Studded screed panel 29/32" (23 mm)			
Item No.	Dimensions/Sheet	Packaging	\$ / Box
EN23F10	120 x 90 cm = 1.08 m ² (47-1/4" x 35-7/16" = 11.63 ft ²)	10 sheets / box	277.09



BRS



BRSK

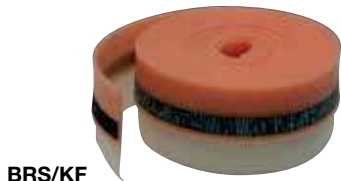

BRS/KF



BRS/KSF

Schluter®-BEKOTEC-BRS		
Edge strip for conventional screed		
Item No.	Dimensions	\$ / Roll
BRS 810	50 m (164') roll: 10 cm wide x 8 mm thick (4" x 5/16")	77.48

Schluter®-BEKOTEC-BRSK		
Edge strip for conventional screed, with adhesive strip		
Item No.	Dimensions	\$ / Roll
BRSK 810	50 m (164') roll: 10 cm wide x 8 mm thick (4" x 5/16")	100.73

Schluter®-BEKOTEC-BRS/KF		
Edge strip for poured screeds, with PE-adhesive leg		
Item No.	Dimensions	\$ / Roll
BRS 808 KF	25 m (82') roll: 8 cm wide x 8 mm thick (3-1/8" x 5/16")	146.35

Schluter®-BEKOTEC-BRS/KSF		
Self-supporting edge strip for poured screed, with PE-adhesive leg		
Item No.	Dimensions	\$ / Roll
BRS 808 KSF	25 m (82') roll: 8 cm wide x 8 mm thick (3-1/8" x 5/16")	197.58

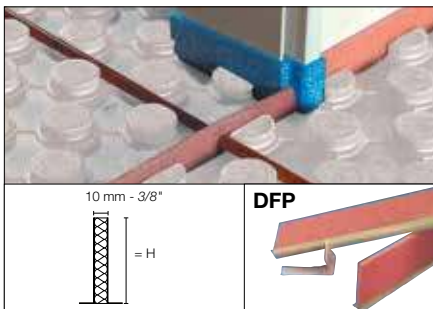

Schluter®-DILEX-DFP		
Length = 1 m - 3' 3"		
Movement joint profile for installation at door areas or for dividing screed surfaces		
H = mm - in.	Item No.	\$ / Length
60 - 2-3/8	DFP 6/100	16.61
80 - 3-1/8	DFP 8/100	19.97
100 - 4	DFP 10/100	23.26

Schluter®-BEKOTEC-THERM-RH 75

Schluter®-BEKOTEC-THERM-RH 75 is a PVC clamp used to attach radiant heating tubes to the BEKOTEC-EN/US/P (1-3/8" - 35 mm)-thick panels. While the studs on the BEKOTEC panel are designed to hold the tubes in place, the clamp is especially useful for forming 45° angles with heating tubes in the studded panel.



Schluter®-BEKOTEC-THERM-RH 75		
Heating Clamps		
Item No.	Quantity	\$ / pkg
BTZRH75/100	100 units / pkg	50.29



Schluter®-Systems

SETTING MATERIALS

Schluter®-Systems' thin-set mortars are premium quality mortars, specifically formulated for use with Schluter® membranes and boards. Unmodified, modified, and rapid-setting versions are available. All are sag-resistant, smooth and creamy, easy to handle and spread, and suitable for use with ceramic, porcelain, and stone tile, including large and heavy tile, in conjunction with Schluter®-Systems' uncoupling and waterproofing membranes (e.g., DITRA, DITRA-HEAT, and KERDI), the Schluter®-Shower System, and Schluter®-KERDI-BOARD.

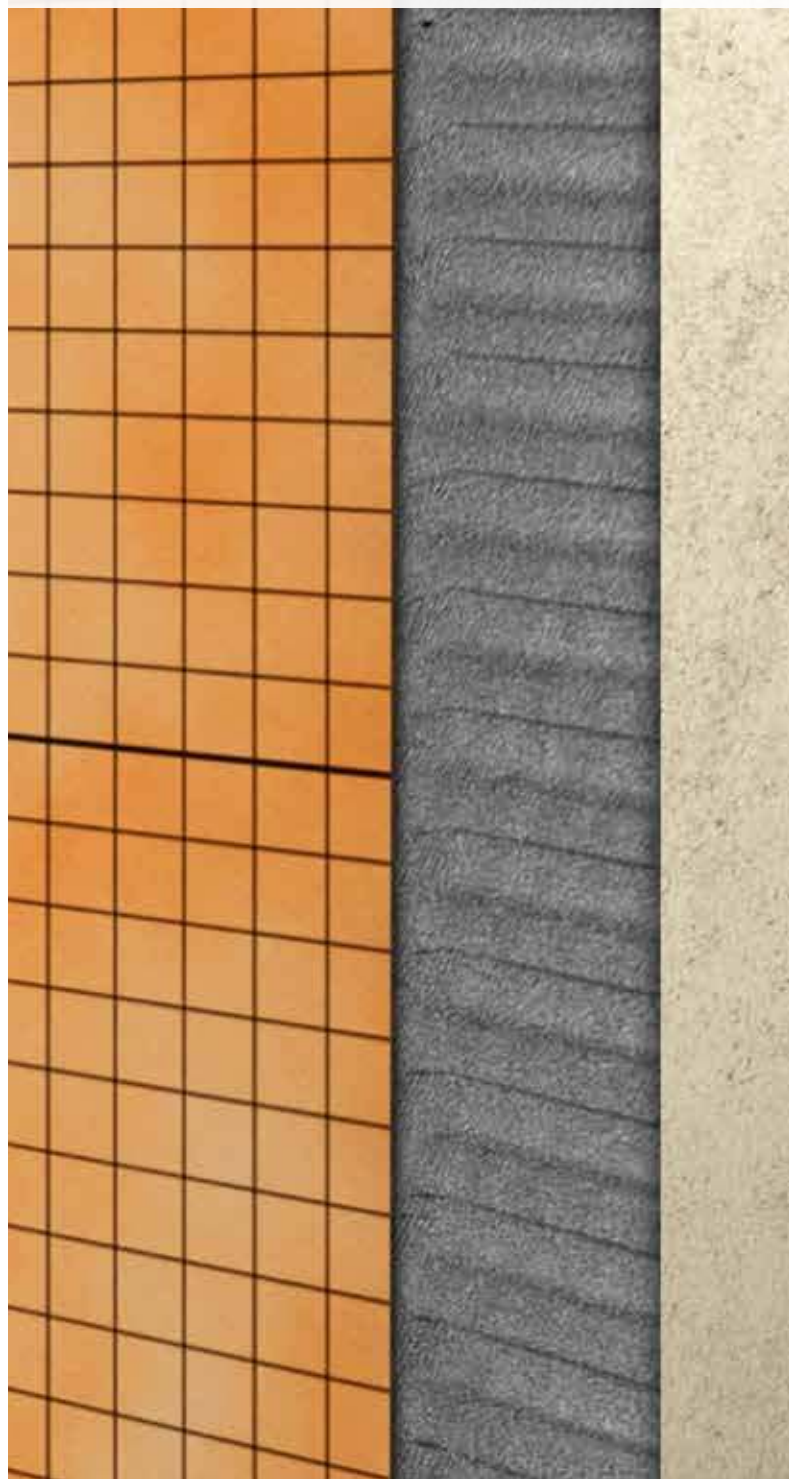

Schluter®-SET

Schluter®-SET is a premium unmodified thin-set mortar specifically formulated for use with Schluter® membranes and boards. It is sag-resistant, smooth and creamy, and easy to handle and spread. Schluter®-SET is suitable for use with ceramic, porcelain, and stone tile, including large and heavy tile, in conjunction with Schluter®-Systems' uncoupling and waterproofing membranes (e.g., DITRA, DITRA-HEAT, and KERDI), the Schluter®-Shower System, and Schluter®-KERDI-BOARD.

Schluter®-SET meets the requirements of ANSI A118.1T, and is available in both grey and white.



Schluter®-SET			
Premium unmodified mortar			
Item No.	Color	Weight	\$
SET50G	Grey	50 lbs - 22.7 kg	Please contact your local Schluter supplier for pricing.
SET50W	White	50 lbs - 22.7 kg	

Schluter®-ALL-SET

Schluter®-ALL-SET is a specialized modified thin-set mortar specifically formulated for use with Schluter® membranes and boards. It is engineered for use both under and over all DITRA and KERDI products. It is sag-resistant, smooth and creamy, and easy to handle and spread. ALL-SET is suitable for use with ceramic, porcelain, and stone tile, including large and heavy tile, in conjunction with Schluter®-Systems' uncoupling and waterproofing membranes (e.g., DITRA, DITRA-HEAT, and KERDI), the Schluter®-Shower System, and Schluter®-KERDI-BOARD.

ALL-SET meets the requirements of ANSI A118.4T, A118.11, and A118.15T, and is available in both grey and white.



Schluter®-ALL-SET			
Specialized modified mortar			
Item No.	Color	Weight	\$
SETA50G	Grey	50 lbs - 22.7 kg	Please contact your local Schluter supplier for pricing.
SETA50W	White	50 lbs - 22.7 kg	

Schluter®-FAST-SET

Schluter®-FAST-SET is a specialized rapid-setting modified thin-set mortar specifically formulated for use with Schluter® membranes and boards. It is engineered for use both under and over all DITRA and KERDI products. FAST-SET is ready to grout in 4 hours for fast-track projects. It is sag-resistant, smooth and creamy, and easy to handle and spread. FAST-SET is suitable for use with ceramic, porcelain, and stone tile, including large and heavy tile, in conjunction with Schluter®-Systems' uncoupling and waterproofing membranes (e.g., DITRA, DITRA-HEAT, and KERDI), the Schluter®-Shower System, and Schluter®-KERDI-BOARD.

FAST-SET meets the requirements of ANSI A118.4TF, A118.11, and A118.15TF, and is available in both grey and white.



Schluter®-FAST-SET			
Specialized rapid-setting mortar			
Item No.	Color	Weight	\$
SETF50G	Grey	50 lbs - 22.7 kg	Please contact your local Schluter supplier for pricing.
SETF50W	White	50 lbs - 22.7 kg	



Quantity per pallet is 56 bags. Minimum order is 4 pallets.
Special freight conditions apply, please see Conditions of Sale on pages 163-164 for details.
Bundle offers for thin-set pallets with other products (i.e. DITRA and KERDI) are available, and are eligible for free shipping.
Please consult a Schluter Sales Representative for more details.



Suitable Uses

Schluter®-DITRA and DITRA-HEAT over	Schluter®-SET	Schluter®-ALL-SET	Schluter®-FAST-SET
Plywood/OSB	X	✓	✓
Concrete	✓	✓	✓
Gypsum	✓	✓	✓
Vinyl flooring	X	X	✓
Schluter®-KERDI over			
Gypsum board	✓	✓	✓
Cement backerboard	✓	✓	✓
Fiber-cement board	✓	✓	✓
Portland cement mortar	✓	✓	✓
KERDI-SHOWER prefabricated substrates	✓	✓	✓
TILE over DITRA, DITRA-HEAT, KERDI and KERDI-BOARD			
Ceramic	✓	✓	✓
Porcelain	✓	✓	✓
Natural stone (e.g., granite, marble, etc.)	✓	✓	✓

- For Schluter®-Systems applications, refer to the Schluter®-DITRA, Schluter®-DITRA-HEAT, and Schluter®-Shower System Installation Handbooks.
- For other applications, refer to TCNA Handbook for Ceramic, Glass, and Stone Tile Installation and TTMAC Specification Guide 09 30 00 Tile Installation Manual.
- Contact Schluter®-Systems Technical Services for installation of glass tile, resin-backed tile, and/or moisture sensitive stone.

✓ = Approved use X = Not recommended

Coverage

Membrane-to-substrate		
Schluter®-DITRA-TROWEL 11/64" x 11/64" (4.5 mm x 4.5 mm)	Schluter®-DITRA-HEAT/-XL-TROWEL 1/4" x 1/4" (6 mm x 6 mm)	Schluter®-KERDI-TROWEL 1/8" x 1/8" (3 mm x 3 mm)
150 ft ² (13.9 m ²)	100 ft ² (9.3 m ²)	200 ft ² (18.6 m ²)

Tile-to-membrane			
Trowel	Schluter®-DITRA/DITRA-HEAT	Schluter®-DITRA-XL	Schluter®-KERDI/KERDI-BOARD
1/4" x 1/4" (6 mm x 6 mm)	60 - 70 ft ² (5.6 - 6.5 m ²)	45 - 55 ft ² (4.2 - 5.1 m ²)	90 - 100 ft ² (8.4 - 9.3 m ²)
1/4" x 3/8" (6 mm x 9.5 mm)	40 - 50 ft ² (3.7 - 4.6 m ²)	35 - 45 ft ² (3.3 - 4.2 m ²)	55 - 65 ft ² (5.1 - 6.0 m ²)
1/2" x 1/2" (12.5 mm x 12.5 mm)	30 - 40 ft ² (2.8 - 3.7 m ²)	25 - 35 ft ² (2.3 - 3.3 m ²)	40 - 50 ft ² (3.7 - 4.6 m ²)
3/4" (19 mm)	25 - 35 ft ² (2.3 - 3.3 m ²)	20 - 30 ft ² (1.9 - 2.8 m ²)	30 - 40 ft ² (2.8 - 3.7 m ²)

Values are approximate

Schluter®-SNIPS

Schluter®-SNIPS are specifically designed to cut PVC trim profiles.



Schluter®-SNIPS	
Item No.	\$ / Unit
PSF	79.79
Replacement blade	
PS 90/45 EK	30.30

Schluter®-PROCUT-TSM

Schluter®-PROCUT-TSM is a cutting wheel with a diameter of 115 mm (4-1/2") for conventional angle grinders. It produces especially clean cuts of stainless steel, aluminum, and brass.



Schluter®-PROCUT-TSM	
Item No.	\$ / Unit
TSM 115/1	13.35

Schluter®-TROWEL

The Schluter®-DITRA-TROWEL, KERDI-TROWEL, and DITRA-HEAT/-DITRA-XL-TROWEL feature square-notched designs to effectively install DITRA, KERDI, DITRA-XL, DITRA-HEAT, and DITRA-HEAT-TB, respectively.



DITRA-TROWEL features a 11/64" x 11/64" (4.5 mm x 4.5 mm) square notch

KERDI-TROWEL features a 1/8" x 1/8" (3 mm x 3 mm) square notch

DITRA-HEAT/-DITRA-XL-TROWEL features a 1/4" x 1/4" (6 mm x 6 mm) square notch

Schluter®-TROWEL			
Item No.	Notch Size	Units / Pkg	\$ / Pkg
KERDI			
TRL-KER	1/8" x 1/8" (3 mm x 3 mm)	1 unit	27.30
TRL-KER6	1/8" x 1/8" (3 mm x 3 mm)	6 units	163.80
DITRA			
TRL-DIT	11/64" x 11/64" (4.5 mm x 4.5 mm)	1 unit	27.30
TRL-DIT6	11/64" x 11/64" (4.5 mm x 4.5 mm)	6 units	163.80
DITRA-HEAT/-DITRA-XL			
TRL-DHXL	1/4" x 1/4" (6 mm x 6 mm)	1 unit	27.30
TRL-DHXL6	1/4" x 1/4" (6 mm x 6 mm)	6 units	163.80

Schluter®-DITRA Roller

DITRA roller is used to embed DITRA/-DITRA-XL in the bond coat during membrane installation. The lightweight DITRA-ROLLER features a 14-1/2" (37 cm) wide roller and a shelf for placing 50 to 75 lbs of weight (e.g., bag of thin-set mortar or grout, box of tiles, etc.). Between uses, it can be conveniently disassembled for transport and storage.



Schluter®-DITRA Roller	
Item No.	\$ / Unit
DIRO	225.00



Schluter®-Systems Tools 2-Year Limited Warranty

COVERAGE AND CONDITIONS: Subject to the conditions and limitations as stated hereinafter, Schluter®-Systems* warrants that Schluter®-Systems Tools (the "Products")** will be free from manufacturing defects in materials and workmanship for a period of two (2) years from the date of purchase only when the Products have been used for their intended purpose in accordance with the Schluter®-Systems Illustrated Price List. Abnormal use, including but not limited to, misuse, accident, modification, unreasonable use, abuse, neglect, lack of maintenance, or use after the product is significantly worn, is not covered by this warranty. Consumable Products or consumable parts of Products are warranted, at the time of sale, only against defects in workmanship or materials that prevent their use. Consumable products or parts are goods reasonably expected to be used up or damaged during normal use, including but not limited to trowels, cutting blades, and cutting wheels. This warranty does not cover normal wear and tear or defects revealed by normal wear and tear.

RESOLUTION: If the Products fail to meet this warranty, then the owner's exclusive remedy and the sole obligation of Schluter®-Systems, at its election, shall be to a) repair or replace the failed Products or b) pay an amount not to exceed the original cost of the Products verified to be defective.

DISCLAIMER: THERE ARE NO WARRANTIES BEYOND THIS EXPRESSED WARRANTY AS STATED ABOVE. ALL OTHER WARRANTIES, REPRESENTATIONS OR CONDITIONS, EXPRESSED OR IMPLIED, ARE DISCLAIMED AND EXCLUDED, INCLUDING WARRANTIES, REPRESENTATIONS OR CONDITIONS OF **MERCHANTABILITY** OR FITNESS FOR A PARTICULAR PURPOSE ARISING BY STATUTE OR OTHERWISE BY LAW OR FROM A COURSE OF DEALING OR USAGE OF TRADE. SCHLUTER®-SYSTEMS EXCLUDES AND IN NO EVENT SHALL HAVE ANY LIABILITY FOR LOST PROFITS OR ANY OTHER INDIRECT, SPECIAL, INCIDENTAL, PUNITIVE, EXEMPLARY, OR CONSEQUENTIAL DAMAGES, ARISING OUT OF OR OTHERWISE CONNECTED TO FAILURE OF THE PRODUCTS, NOR MISUSE OF THE PRODUCTS, REGARDLESS OF ANY STRICT LIABILITY, ACTIVE OR PASSIVE NEGLIGENCE OF SCHLUTER®-SYSTEMS, AND REGARDLESS OF THE LEGAL THEORY (CONTRACT OR TORT OR EXTRA-CONTRACTUAL OR OTHER), NOR FROM ACTS OF WAR, TERRORISM, FIRES, EXPLOSIONS, ACTS OF GOD, INTENTIONAL ACTS OF DESTRUCTION OR ANY LOSSES DUE TO CAUSES UNRELATED TO THE PRODUCT OR DELAYS, OR ANY OTHER INCIDENTAL OR CONSEQUENTIAL DAMAGES. THIS WARRANTY IS GIVEN IN LIEU OF ANY OTHER WARRANTY EXPRESSED OR IMPLIED. THE REMEDIES CONTAINED HEREIN ARE THE ONLY REMEDIES AVAILABLE FOR BREACH OF THIS WARRANTY. THIS LIMITED WARRANTY GIVES YOU SPECIFIC LEGAL RIGHTS, SOME STATES AND PROVINCES DO NOT ALLOW DISCLAIMERS OR OTHER RESTRICTIONS OF IMPLIED WARRANTIES SO SOME OF THE ABOVE LIMITATIONS MAY NOT APPLY TO YOU.

TRANSFERRABILITY: This Limited Warranty extends ONLY to the original intended owner (defined as original purchaser of the tool – herein after referred to as "Owner") and is not transferable or assignable, unless otherwise prohibited by specific state or provincial law.

MODIFICATIONS TO WARRANTY: No changes or modification of any terms or conditions of this warranty are allowed unless authorized by written agreement and signed by the Technical Director or an Officer of Schluter®-Systems.

EFFECTIVE DATE: This warranty shall supersede and replace any and all prior oral or written warranties, agreements, or other such representations made by or on behalf of Schluter®-Systems relative to the Products or the use of the Products and shall apply to any purchase occurring on or after January 1, 2013.

CLAIMS ON THIS LIMITED WARRANTY: To make a claim under this Limited Warranty, the owner must provide Schluter®-Systems with written notice within 30 days of any alleged defect in the Products covered by this Limited Warranty, together with date and proof of purchase of the Products, failing which this Limited Warranty shall be of no legal effect. Schluter®-Systems reserves the right at its election and as a condition of this Limited Warranty to inspect the alleged failed and defective condition.

All U.S. Claims shall be sent to:

Schluter Systems L.P.
Attn: Warranty Claims Dept.
194 Pleasant Ridge Road
Plattsburgh, NY 12901-5841

All Canadian Claims shall be sent to:

Schluter Systems (Canada), Inc.
Attn: Warranty Claims Dept.
21100 ch. Ste-Marie
Ste-Anne-de-Bellevue, QC H9X 3Y8

*For the purpose of this warranty Schluter Systems, L.P. shall provide the warranty for all products for end users located in the United States, and SchluterSystems (Canada) Inc. shall provide the warranty for all products for end users located in Canada. This warranty is limited to sales of the products made in and intended for use in the United States and Canada.

**Schluter®-Systems Tools (the "Products"): The products are defined to include all Schluter®-Systems tools referred to in the Schluter®-Systems Illustrated Price List.

Material Properties and Areas of Application

Schluter® profiles are resistant to most chemicals encountered in tiled environments. In special cases, the suitability of a proposed type of material must be verified based on the anticipated chemical, mechanical, and/or other stresses. Exceptions and special considerations are listed below.

Stainless steel profiles are roll-formed, resulting in a slightly different contour from those made of extruded brass or aluminum. Stainless steel can sustain high mechanical stresses and is particularly well suited for applications requiring resistance against chemicals and acids; for example in the food industry, breweries, dairies, commercial kitchens, and hospitals, as well as in residential applications. Typically, the profiles are formed using stainless steel 304 (1.4301 = V2A). For more severe chemical exposure, such as de-icing salts and chemicals used in swimming pools, we recommend the use of stainless steel 316 L (1.4404 = V4A), which offers even higher corrosion resistance than the 304. Even stainless steel cannot withstand all chemical exposures, such as hydrochloric acid, hydrofluoric acid or certain chlorine, chloride and brine concentrations.

Solid brass sustains high levels of mechanical stress; for example, as edge protection for outside wall corners or edges of surface coverings. Brass is resistant to most chemicals used in tiled environments. Solid brass that is

exposed to air will oxidize, resulting in a natural patina. If exposed to moisture or aggressive substances, heavy oxidation and spotting may occur.

Chrome-plated brass is especially suited for wall corners and finishing applications. It is ideal for matching chrome fixtures. Surface areas must be protected against abrasion or scratching.

Aluminum profiles must be tested to verify their suitability if chemical stresses are anticipated. Cementitious materials, in conjunction with moisture, become alkaline. Since aluminum is sensitive to alkaline substances, exposure to the alkali (depending on the concentration and duration of exposure) may result in corrosion (aluminum hydroxide formation). Therefore, it is important to remove mortar or grout residue from visible surfaces. In addition, ensure that the profile is solidly embedded in the setting material and that all cavities are filled to prevent the collection of alkaline water.

Anodized aluminum profiles feature an anodized layer that retains a uniform appearance during normal use. The surface, however, is susceptible to scratching and wear and may be damaged by grout or setting material. Therefore, these materials must be removed immediately. Otherwise, the description regarding aluminum applies.

Color-coated aluminum and **textured color-coated aluminum** are pretreated (chromated) aluminum that is color-coated with a polyurethane powder coat. The coating is color-stable, UV-resistant, and suitable for exterior use. Protect the profile against abrasion or scratching.

PVC profiles are made of pre-colored, rigid PVC that resists bending or scratching. The material is UV-resistant, though not permanently color-stable, in exterior applications. PVC profiles are not suited for corners or transitions subjected to heavy mechanical stresses (e.g., at step edges or floor transitions).

STAINLESS STEEL, CHROME-PLATED BRASS, AND SOLID BRASS



E Stainless steel 304 (1.4301=V2A)
High-grade stainless steel 316 L
(1.4404=V4A)



EB Brushed stainless steel



MC Chrome-plated solid brass



M Solid brass



ES1 Stainless steel 304
(1.4301=V2A) square check



ES2 Stainless steel 304
(1.4301=V2A) leather texture

ALUMINUM



A Aluminum

ANODIZED ALUMINUM

Polished and bright anodized aluminum



ACG Polished chrome
anodized aluminum
ACB Bright chrome
anodized aluminum

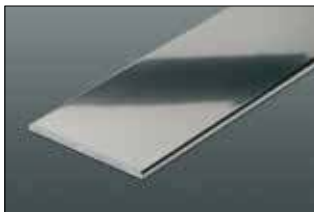

ATG Polished nickel
anodized aluminum
ATB Bright nickel
anodized aluminum

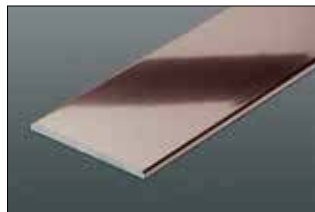

AKG Polished copper
anodized aluminum
AKB Bright copper
anodized aluminum

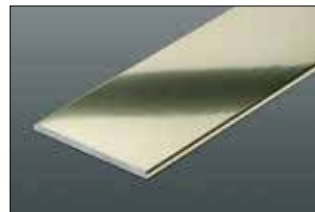

AMG Polished brass
anodized aluminum
AMB Bright brass
anodized aluminum



AGSG Bright black
anodized aluminum

Satin anodized aluminum



AE Satin anodized aluminum



AT Satin nickel
anodized aluminum



AK Satin copper
anodized aluminum



AM Satin brass anodized
aluminum



AGR Graphite anodized aluminum

Brushed anodized aluminum



ACGB Brushed chrome
anodized aluminum



ATGB Brushed nickel
anodized aluminum



AKGB Brushed copper
anodized aluminum



AMGB Brushed brass
anodized aluminum



ABGB Brushed antique bronze
anodized aluminum



AGRB Brushed graphite
anodized aluminum



AGSB Brushed black
anodized aluminum

TEXTURED COLOR-COATED ALUMINUM

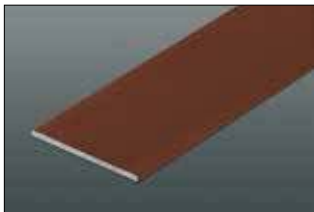

TSR Rustic brown
textured color-coated
aluminum



TSDA Dark anthracite
textured color-coated
aluminum



TSLA Light anthracite
textured color-coated
aluminum



TSSG Stone grey
textured color-coated
aluminum



TSC Cream
textured color-coated
aluminum



TSBG Greige
textured color-coated
aluminum



TSI Ivory
textured color-coated
aluminum



TSB Beige
textured color-coated
aluminum



TSOB Bronze
textured color-coated
aluminum



TSG Pewter
textured color-coated
aluminum

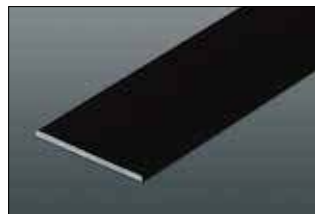

MGS Matte black
textured color-coated
aluminum
RAL 9005



MBW Matte white
textured color-coated
aluminum
RAL 9003

COLOR-COATED ALUMINUM



BW Bright white color-coated aluminum RAL 9003



W White color-coated aluminum RAL 9010



SP Sand pebble color-coated aluminum RAL N/A

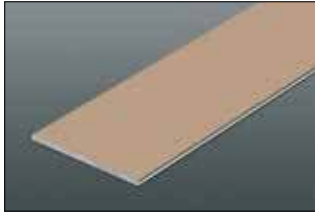

BH Bahama color-coated aluminum RAL N/A

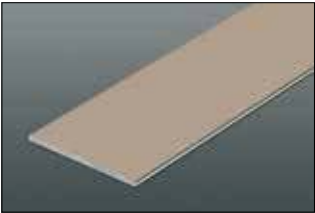

HB Light beige color-coated aluminum RAL 1019

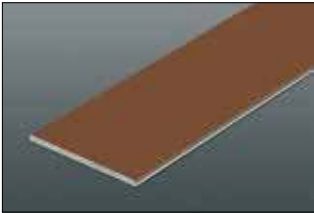

RB Red brown color-coated aluminum RAL 8003

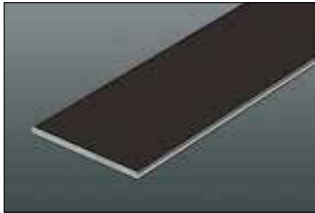

SB Black brown color-coated aluminum RAL 8019

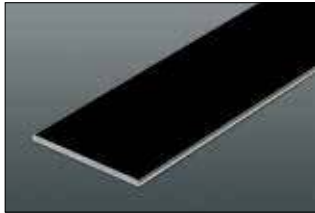

GS Black color-coated aluminum RAL 9011

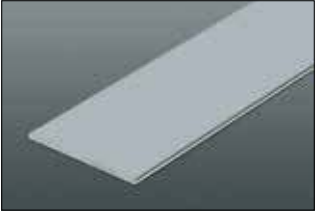

HG Light grey color-coated aluminum RAL 7035

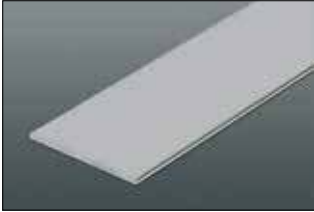

PG Classic grey color-coated aluminum RAL N/A

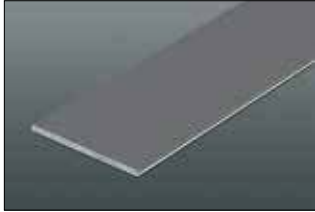

G Grey color-coated aluminum RAL 7030

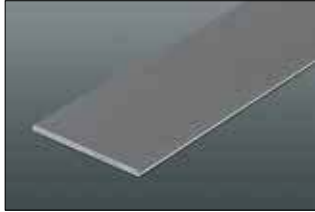

GM Metallic grey color-coated aluminum RAL 9006

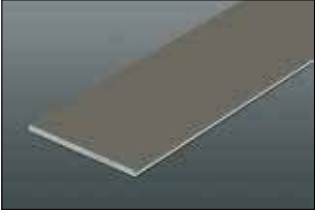

QG Quartz grey color-coated aluminum RAL 7039

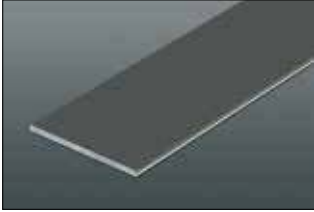

VG Traffic grey color-coated aluminum RAL 7043

PVC

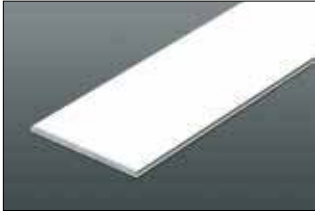

BW Bright white
PVC
RAL 9003

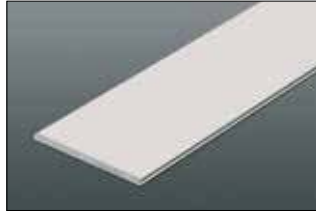

W White
PVC
RAL 9010



SP Sand pebble
PVC
RAL N/A

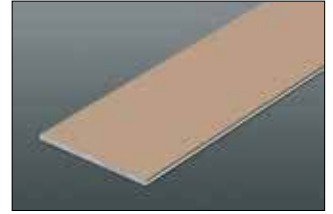

BH Bahama
PVC
RAL N/A

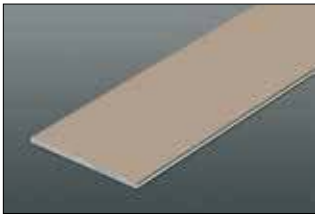

HB Light beige
PVC
RAL 1019



GS Black
PVC
RAL 9011

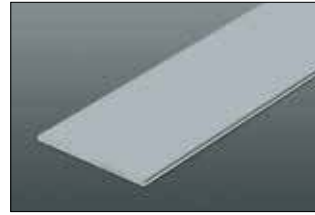

HG Light grey
PVC
RAL 7035

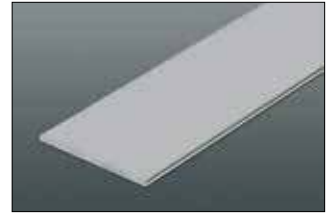

PG Classic grey
PVC
RAL N/A



G Grey
PVC
RAL 7030

Warranty Program Summary

All Schluter®-Systems products are covered under our warranty program. Products are warranted for the applicable term from the date of purchase only when the products are used and installed in accordance with the terms and conditions of the applicable Schluter®-Systems technical literature and industry standard guidelines that are not in conflict with the technical literature.

There are four different categories of warranties as follows:

Systems

Systems are application based and include a variety of products that form an integrated system. Systems are defined by installation handbooks.

- Schluter®-DITRA and Schluter®-DITRA-XL uncoupling membranes
- Schluter®-DITRA-HEAT electric floor warming system with integrated uncoupling technology
- Schluter®-Shower System

Lifetime

When you install Schluter®-DITRA /DITRA-XL, the Schluter®-Shower System, KERDI / KERDI-DS, DITRA-HEAT or DITRA-HEAT-DUO with one of our Schluter thin-set mortars, your installation may be eligible for limited lifetime warranty coverage.

Consolidated Products

Consolidated products are products with similar characteristics or functions that are grouped under a single warranty document. These product groups are defined by technical data sheets.

- Floor profiles
- Wall and countertop profiles
- Stair-nosing profiles
- Movement joints and cove-shaped profiles
- Schluter®-BEKOTEC modular screed panels
- Schluter®-KERDI-DRAIN and Schluter®-KERDI-LINE floor drains
- Schluter®-KERDI and Schluter®-KERDI-DS waterproofing membranes
- Schluter®-SET, Schluter®-ALL-SET and Schluter®-FAST-SET thin-set mortars

Individual Products

Individual products are those that do not fit into a current consolidated product group and therefore have a separate warranty document. These products are defined by technical data sheets.

- Schluter®-KERDI-BOARD building panels
- Schluter®-KERDI-FIX adhesive/sealant
- Tools

For complete warranty information, please see our website: www.schluter.ca/warranty

CONDITIONS OF SALE

1. Terms and Conditions

These terms and conditions of sale (hereinafter referred to as the "Terms") govern the sale of Products from Schluter Systems (Canada) Inc. ("Schluter") to Customer where such products are to be used within Canada. "Products" is defined to mean the products identified on the order confirmation or invoice, whichever is issued later by Schluter to Customer; and "Customer" is defined to mean the purchasing entity identified on such documents. The Terms herein, the terms and conditions contained on any order confirmation and/or invoice, and the terms and conditions contained in any applicable Credit Application, and/or supply agreement between Schluter and Customer, if any, represent the final and complete agreement of Schluter and Customer as to the sale and purchase of Products (the "Agreement"). In the event of any conflicting terms or conditions in the Agreement, the supply agreement, if any, shall be deemed to control; in the absence of a supply agreement, the order confirmation shall be deemed to control. Any and all different or additional terms than those contained in the Agreement are rejected unless expressly accepted in writing by an authorized representative of Schluter.

2. Price and Payment

Payment terms are net thirty (30) days from invoice date. No payments shall be subject to any setoffs, deductions or claims. For any amounts not paid by Customer as of the due date, Customer shall be liable to pay interest on the amount due at a rate of 1.5% per month from due date until date of payment in addition to the principal amount. Regardless of any statement appearing on a check or otherwise, Schluter's acceptance of a payment in an amount less than that due shall in no way be an accord and satisfaction or prejudice Schluter's rights and remedies to collect the full amount due. Prices do not include sales taxes or other charges levied by any governmental authority upon the sale, use or transportation of the Products, all of which shall be paid by Customer, including, without limitation, applicable customs duties and tariffs. Prices quoted in the Price List Catalog are subject to change without prior notice. For the most current version of the Price List, please visit www.schluter.ca.

3. Shipping/Title/Risk of Loss

Unless otherwise expressly set forth in writing by Schluter, all Products will be delivered Ex Works (as defined in Incoterms 2017 revision). Dates of shipments are estimated and not guaranteed. Title and risk of loss to Products shall transfer to Customer upon delivery in accordance with the applicable delivery terms. Any handling of the Products after transfer of risk of loss shall be at Customer's sole risk.

4. Freight and Shipping Charges

Prices quoted in the Price List Catalog include ground freight charges within Canada, save and except for purchase orders under \$5,000.00 gross, to which a \$50 additional charge shall be added thereto. Schluter offers air express shipping to Canada; please see table below for options and pricing. Please allow 1 to 3 business days for delivery on air express shipping.

Air Express Handling Freight Charges			
Gross order value at retail	up to \$500	\$500 to \$1500	\$1500 to \$3000
Charge	\$ 100	\$ 175	\$ 250

Express orders greater than \$3,000 gross at retail are charged actual freight.

Certain items with oversized shipping dimensions are not eligible for express shipping. Additionally, certain items (such as 10' profiles) are not eligible for parcel shipping and are subject to a \$200 charge unless combined with an order exceeding a \$5,000 retail value.

Freight charges including air express handling charges are subject to change without prior notice. Please note that we are unable to accommodate third party transport billing.

Accessories include corners and caps for profiles and Rema kits up to \$250 value at retail:

- \$25 is added for regular ground handling
- \$70 is added for next-day express handling

KERDI-BOARD panels:

- 1 to 5 full pallets: \$150/pallet
- 6+ full pallets: free shipping

THIN-SET pallets: minimum order equals 4 full pallets (1 pallet equals 56 bags per item number)

- 4 to 14 full pallets: \$500 freight charge per order
- 15 pallets: free shipping

Bundle offers for thin-set pallets with other products (i.e. DITRA and KERDI) are available and are eligible for free shipping. Please consult with a Schluter Sales Representative for more details.

3rd party shipping (drop shipping):

- Orders to a third party will incur a 10% handling fee.
- THIN-SET only orders to a third party will incur a \$200 handling fee.

5. Product Inspection; Non-conformity

Customer must inspect the Products upon delivery and notify Schluter in writing of any physical damage to the Products or nonconformity with the purchase order or invoice. FAILURE TO INSPECT AND DELIVER WRITTEN NOTICE OF SUCH DAMAGE OR NONCONFORMITY WITHIN SUCH FORTY EIGHT (48) HOUR PERIOD SHALL CONSTITUTE IRREVOCABLE ACCEPTANCE OF THE DELIVERED PRODUCTS AND A WAIVER OF ANY DAMAGE OR NONCONFORMITY THAT WAS OR SHOULD HAVE BEEN DETECTED. Any use of the Products or any portion thereof shall constitute irrevocable acceptance of such Products. As Customer's sole remedy for any damaged or nonconforming Products of which Customer has delivered to Schluter timely notice of damaged or nonconforming Products, Schluter, at Schluter's sole election, shall either: (a) replace the damaged or nonconforming Products, or (b) refund the price paid by Customer to Schluter for such damaged or nonconforming Products. In no event shall Schluter be liable for costs of procurement or substitute Products by Customer, or for injury or damage to business, or loss of profits, nor shall Schluter be liable for any incidental, special, indirect, or consequential damages. Any Product images are for illustrative purposes only; any differences between Product images and actual Product received shall not constitute nonconforming Product.

6. Cancellations

If Customer fails to make payment in accordance, or otherwise comply, with all terms of the Agreement, Schluter may, at its option (and in addition to all other remedies), cancel any unshipped portion of Customer's order, without liability to Schluter, and Customer shall remain liable for all unpaid amounts. Subject only to Section 5 herein, orders, once accepted by Schluter, cannot be cancelled without Schluter's prior written consent, which may be granted or withheld in Schluter's sole and absolute discretion. In no event shall Schluter authorize the cancellation or deferment of shipment unless Schluter is indemnified against the loss resulting therefrom. Orders issued a tracking number are considered shipped; any cancellation or deferment will incur a 25% restocking fee.

7. Returns

Schluter shall not accept any returns unless it specifically authorizes such in writing, which may be granted or withheld in Schluter's sole and absolute discretion. Under no circumstances shall Schluter accept any returned Products after thirty (30) days from such Products' invoice date. Any authorized returns must be in resellable condition subject to inspection by Schluter prior to acceptance of same. All authorized returns shall incur a handling charge of 25%.

8. Special Orders

Customer will defend, at its own expense, any suit which may be brought against Schluter by reason of the manufacture or sale of special or non-stock Products made to Customer's specifications, including any third party proceedings. In the case of cancellation of orders of special or non-stock Products, Customer's cancellation may be conditioned upon Customer's payment in full of the price of finished Products. Schluter shall not accept any returns of special or non-stock Products.

9. Warranty and Damages Disclaimer

a. Warranty The Products are covered by product-specific warranties, available at www.schluter.ca or Schluter's Warranties Page. The warranty that applies is the applicable warranty in effect for the Products as of the date of the proforma invoice, or if no proforma invoice, as of the date of the order acknowledgement for the Products (the "Written Warranty").

b. Disclaimer THE WRITTEN WARRANTY IS THE ONLY WARRANTY APPLICABLE TO THE PRODUCTS AND EXCLUDES ALL OTHER WARRANTIES, INCLUDING, WITHOUT LIMITATION, ANY IMPLIED WARRANTY OF MERCHANTABILITY OR FITNESS FOR A PARTICULAR PURPOSE, AND ANY IMPLIED WARRANTIES OTHERWISE ARISING FROM A COURSE OF DEALING OR USAGE OF TRADE, EXCEPT WHERE PURCHASE OF THE PRODUCTS IS SUBJECT TO CONSUMER PRODUCT WARRANTY LAWS, IN WHICH INSTANCES ANY APPLICABLE IMPLIED WARRANTIES ARE LIMITED TO THE PERIOD OF THE APPLICABLE WRITTEN WARRANTY, OR SUCH SHORTER PERIOD AS PERMITTED OR REQUIRED UNDER APPLICABLE LAW. IN NO EVENT WILL SCHLUTER BE LIABLE FOR ANY INCIDENTAL, SPECIAL, INDIRECT, OR CONSEQUENTIAL DAMAGES, HOWEVER CAUSED, WHETHER FOR BREACH OF CONTRACT, BREACH OF WARRANTY, TERMINATION, NEGLIGENCE, OR OTHERWISE, EVEN IF SCHLUTER SHALL HAVE BEEN ADVISED OF THE POSSIBILITY OF SUCH DAMAGES. Recommendations, advice, representations, warranties, commitments or agreements that are inconsistent with the foregoing disclaimer shall not be binding on Schluter unless in a writing signed by an authorized representative of Schluter. Schluter's only obligation is to provide the Products in the quantities ordered by Customer (which order is accepted by Schluter) without regard to the Products' appropriateness to Customer's application. Customer represents and warrants that Customer is not a "consumer" as defined by any applicable usury or consumer protection laws.

10. Delay/Force Majeure

Delay in delivery or nondelivery by Schluter shall not be a breach or default by Schluter if performance is delayed or made impracticable or impossible by the occurrence of any one or more of the following: (a) fire, flood, or other casualty, (b) war, riot, embargo, governmental regulation or martial law, (c) inability to obtain necessary materials from usual sources of supply, (d) shortage of transportation or delays in transit, (e) strike or other labor issue, and (f) other conditions not reasonably within Schluter's control, whether or not of a kind mentioned herein.

11. Choice of Law

For sales made in Canada or its territories, the Agreement (including, without limitation, these Terms) shall be governed by the Province of Quebec, without regard for its choice of law provisions.

12. Arbitration

a. Any controversy, claim or dispute arising out of or in connection with the Agreement shall be settled by final and binding arbitration administered by the Canadian Arbitration Association in accordance with its Arbitration Rules in the judicial district of Montreal, province of Quebec and judgment on the award rendered by the arbitrator may be entered in any court having jurisdiction. The arbitration shall be heard by a single arbitrator appointed in accordance with the Arbitration Rules, and shall be conducted in English.

b. If a controversy or claim relates to or is the subject of a mechanic's or construction lien, Schluter may proceed in accordance with applicable law to preserve and enforce its lien rights. TO THE FULLEST EXTENT PERMITTED BY LAW, NOTWITHSTANDING ANY ARBITRATION RULE OR PROCEDURE, (A) NO CONTROVERSY OR CLAIM ARISING OUT OF OR RELATING TO THE AGREEMENT SHALL BE CONSOLIDATED OR JOINED WITH ANY OTHER PERSON'S CLAIM AND NO CLASS ACTION OR REPRESENTATIVE ACTIONS SHALL BE PERMITTED UNDER THE AGREEMENT, AND (B) IF ANY CLASS OR REPRESENTATIVE ACTION CANNOT BE WAIVED UNDER APPLICABLE LAW, THE PARTIES AGREE THAT SUCH ACTION SHALL BE ARBITRATED.

13. Miscellaneous

No amendment, alteration, variation, deletion, addition, and/or cancellation of these Terms made by Customer shall be of any force or effect unless reduced to writing and signed by a director of Schluter. If any clause, subclause, or other provision of these Terms is invalid under any statute or rule of law, such provision, to that extent only, shall be deemed to be omitted without affecting the validity of the remainder of the Terms. Customer shall pay to Schluter all costs of collection, including, without limitation, reasonable attorneys' fees, incurred by Schluter in enforcing the Agreement, including, without limitation, collecting any money due from Customer and enforcing Schluter's lien rights. No waiver by Schluter of any term or any obligation of Customer shall constitute a waiver of any other term or obligation. Customer shall not assign or transfer its rights or obligations under the Agreement without the prior written consent of Schluter. All of Customer's representations, warranties and indemnities under the Agreement shall survive the consummation of or the termination or cancellation of any purchase and sale of Products. Which party prepared the Agreement shall have no bearing on the construction or interpretation of the Agreement. Buyer will defend, at its own expense, any suit or legal proceeding, including any third party proceedings, which may be brought against Schluter by reason of the manufacture or sale of any special product(s) made to Buyer's specifications. These Terms supersede all prior versions of Schluter's Conditions of Sale. Schluter reserves the right in its sole discretion to amend these Terms from time to time and any such amended terms and conditions shall be binding on Customer. For the most current version of the Terms, please visit www.schluter.ca/terms.

Copyright Notice

The Schluter®-Systems Illustrated Price List is protected by copyright laws. Its entire content, including images and text, may not be reproduced, distributed, modified, reused, or otherwise used without the express written permission of Schluter®-Systems.

© 2019 Schluter Systems L.P. and affiliates. All Rights Reserved.

Trademark Notice

All product names, logos and/or designs, including but not limited to those listed on our website, www.schluter.ca/trademarks, are owned by Schluter Systems L.P. and/or affiliates. It may not be a complete list of trademarks owned by Schluter®-Systems as it does not list all common law trademarks and trademark applications or registrations worldwide. The unauthorized use or misuse of these trademarks is expressly prohibited and may be in violation of intellectual property rights which shall be enforced.

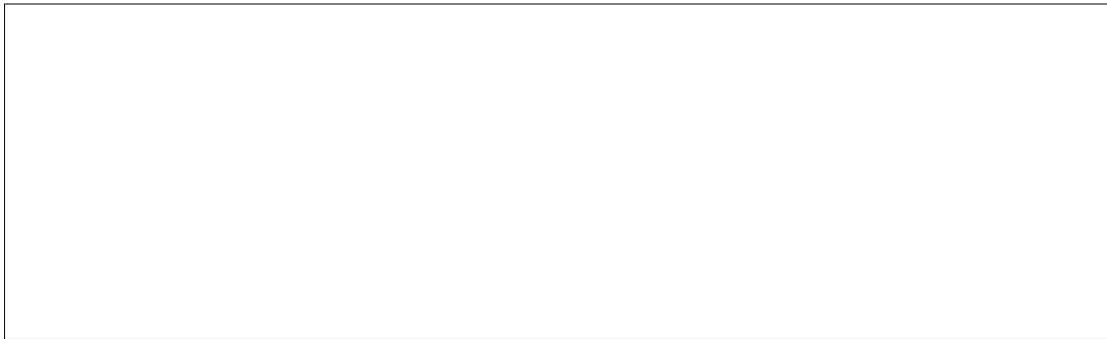

Schluter Systems (Canada) Inc. • 21100 chemin Ste-Marie, Ste-Anne-de-Bellevue, QC H9X 3Y8
Tel.: 800-667-8746 • Fax: 877-667-2410

www.schluter.com